

Bauanleitung

Flexi Ball B1234

Das **Modell B1234** besteht aus folgenden Farben:

1. Hauptfarbe = weiß
2. Nebenfarbe = schwarz, orange, grau
3. Eckfarbe = rot, blau, gelb, grün

Die Bauanleitung kann heruntergeladen werden unter:

www.flexi-klemmbausteine.de



Das Produkt beinhaltet keine Steine des dänischen Markenherstellers.



Achtung!
Erstickengefahr! Enthält Kleinteile!

Warning!
Choking hazard! Small parts!

Attention!
Risque d'étouffement! Petities pieces!



1
HF

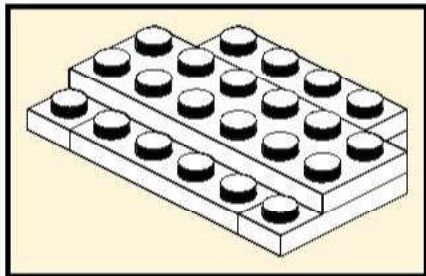

2x

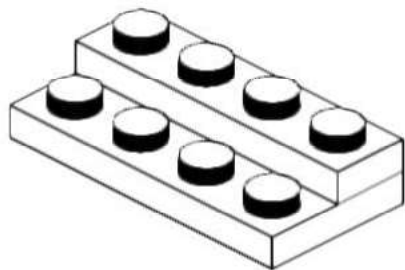
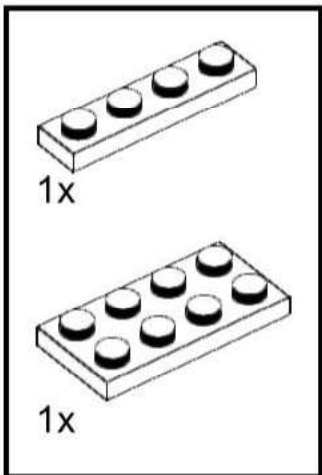

2

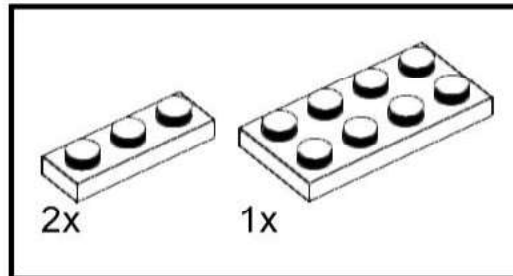

3

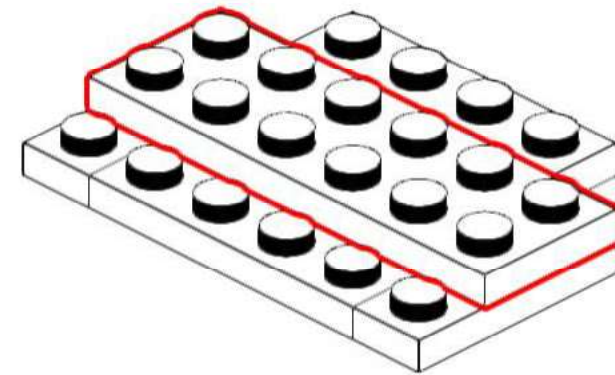
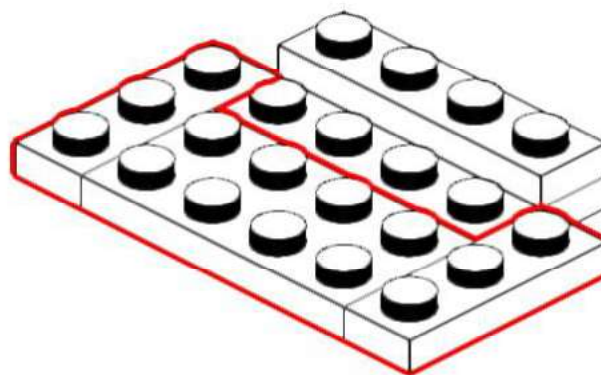
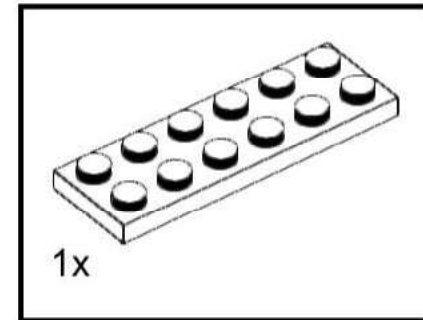

4

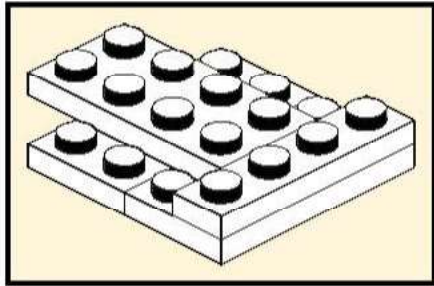

2x

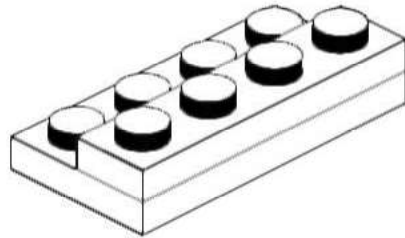
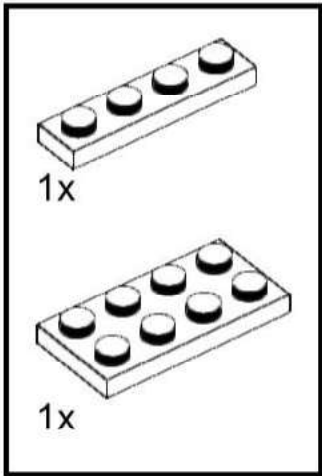

5

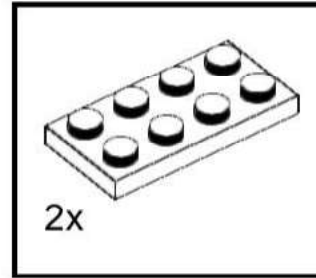

2x

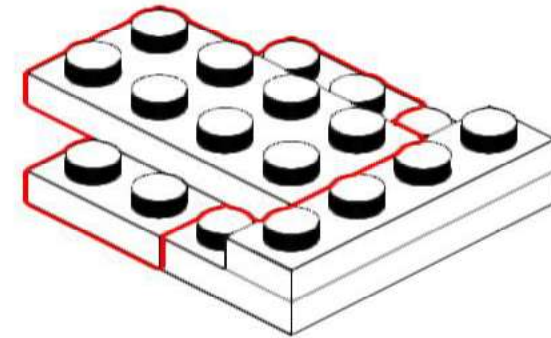

6

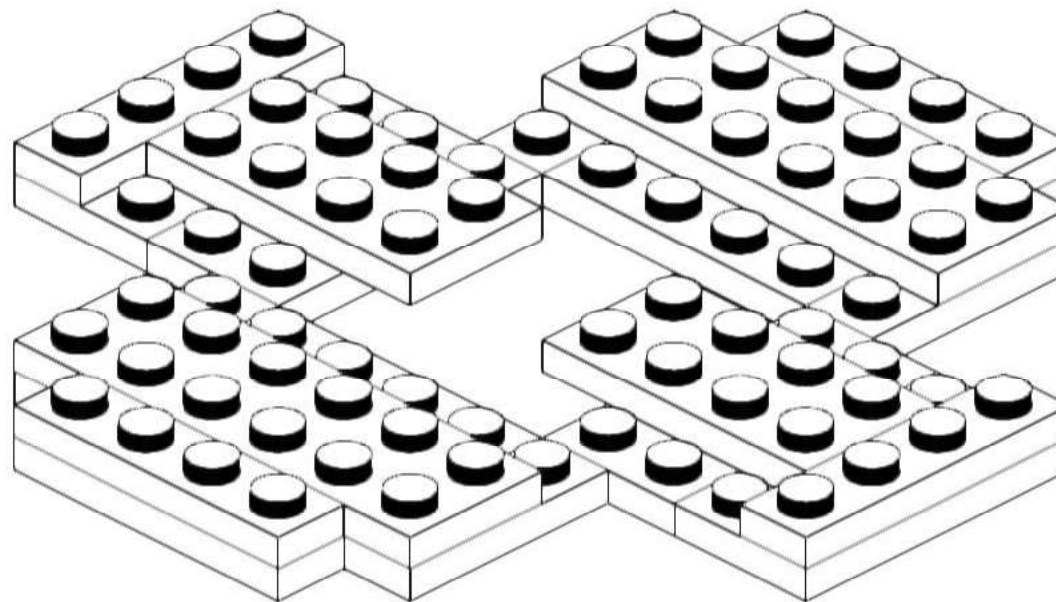

7

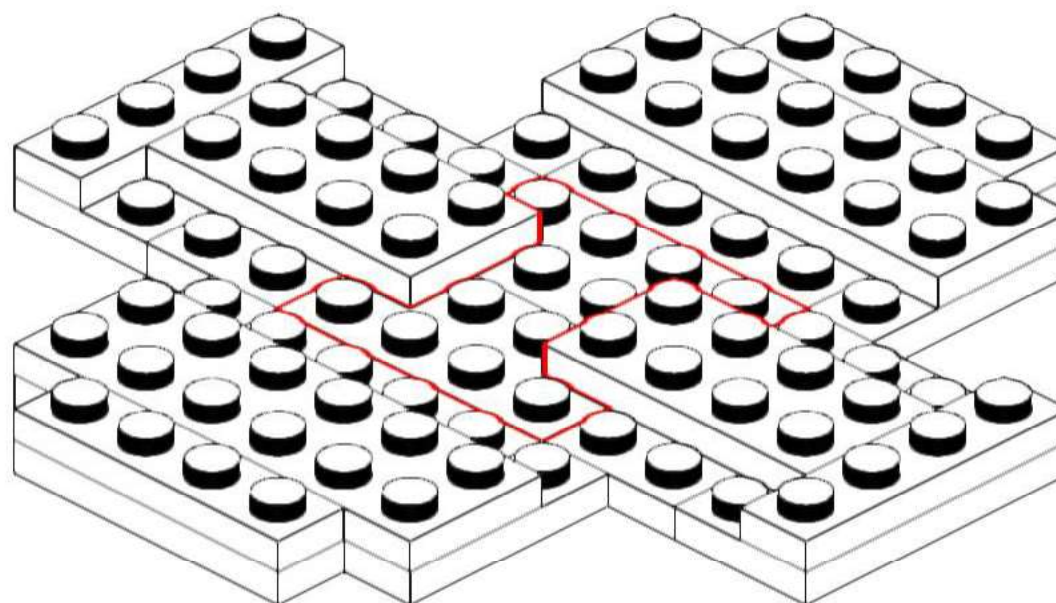
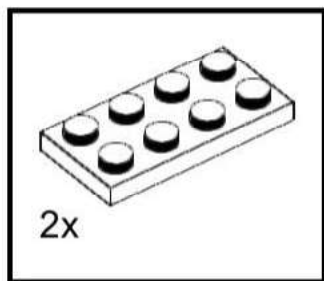

8

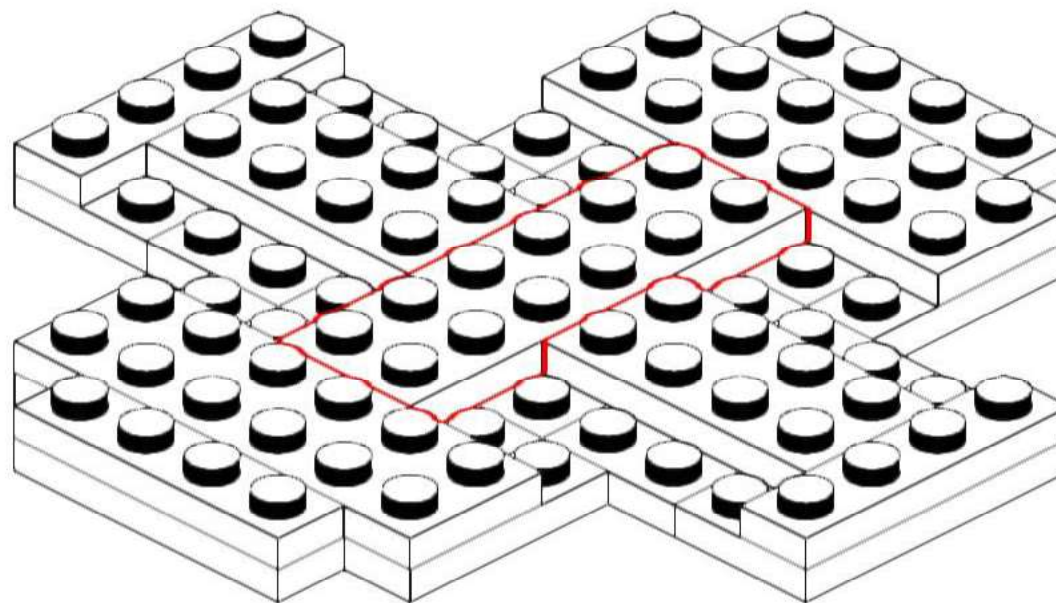
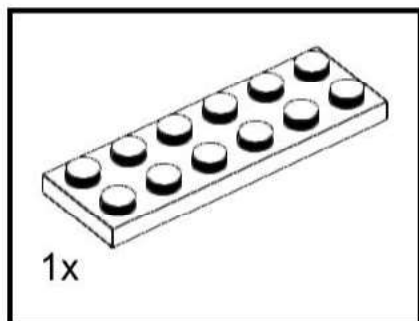

9

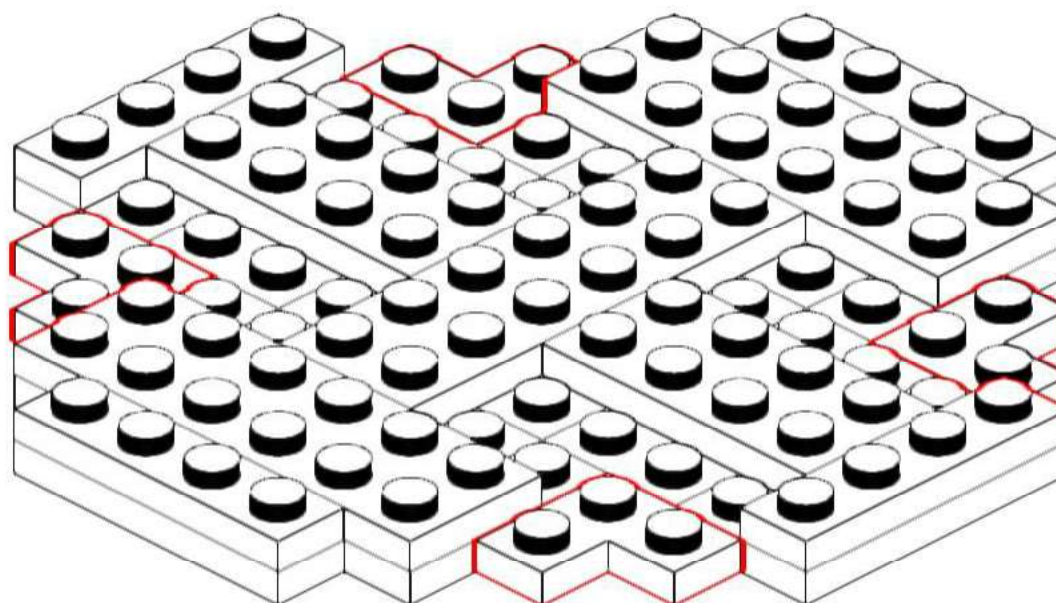
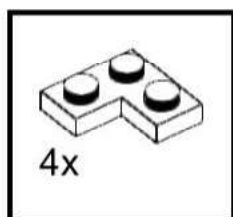

10

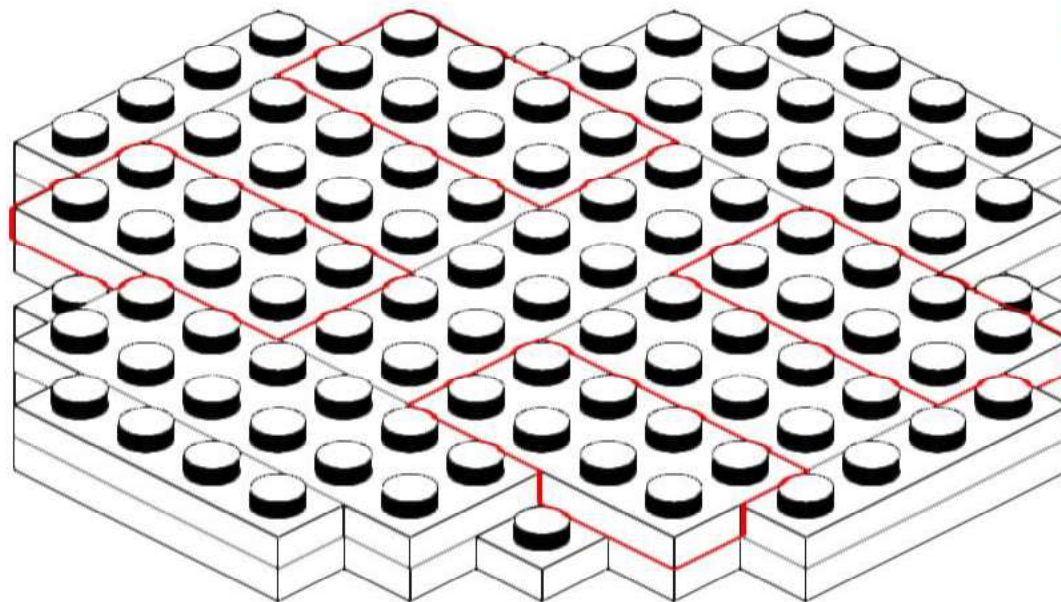
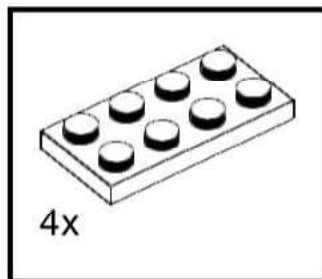

11

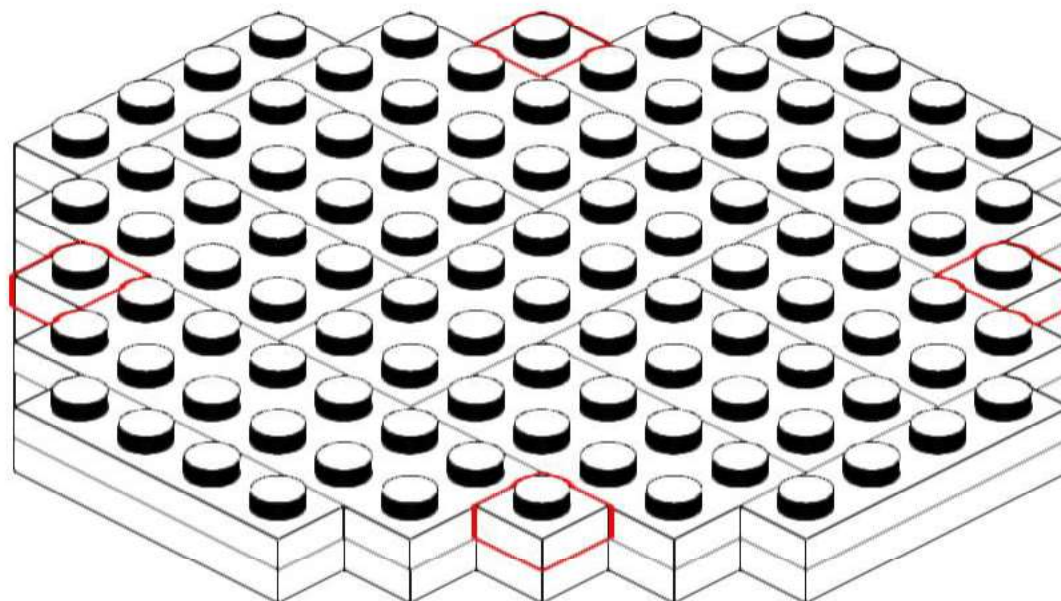
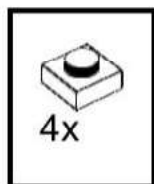

12

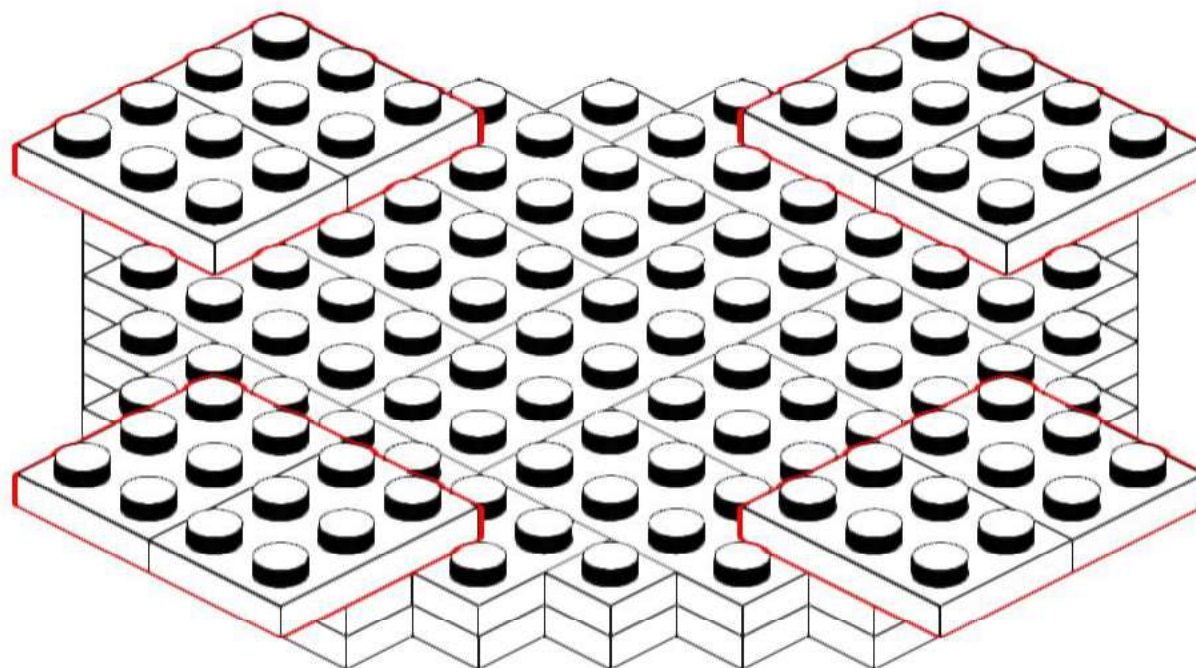
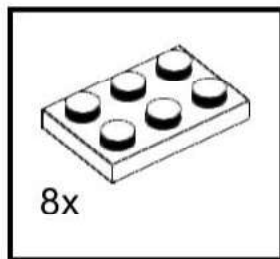

13

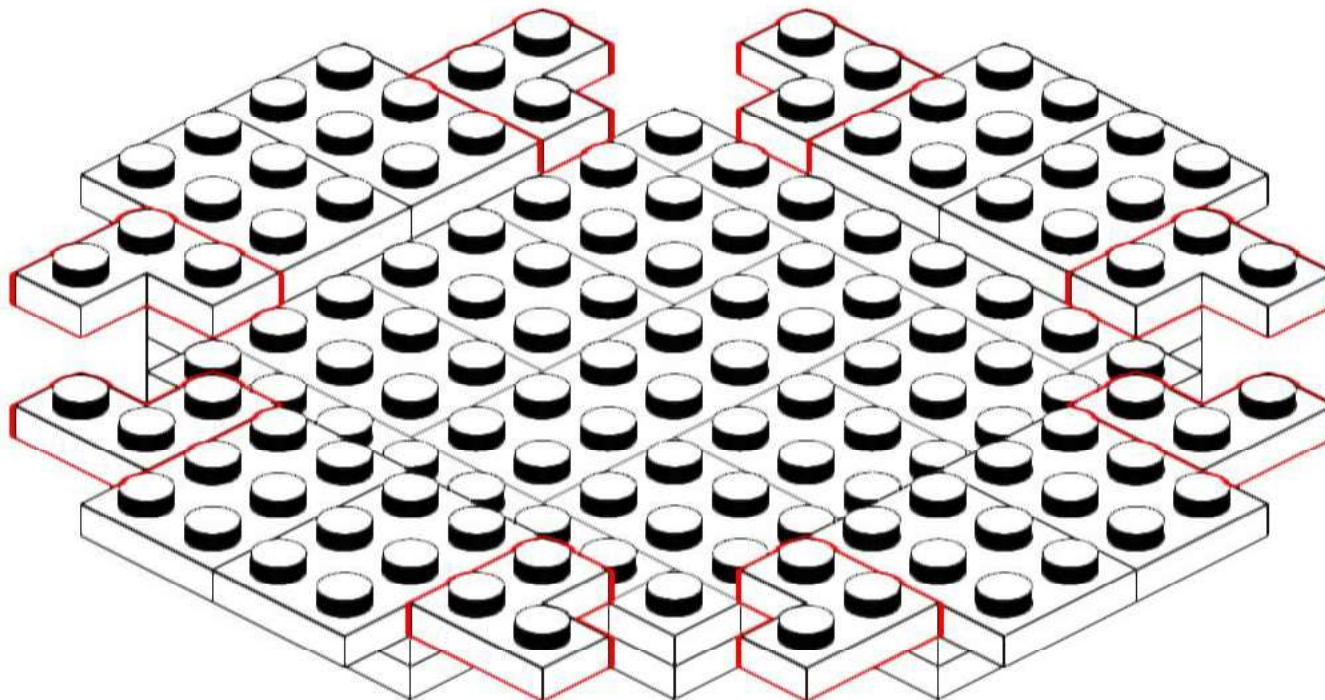
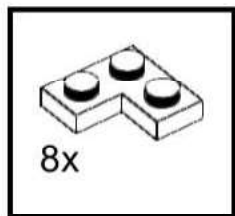

14

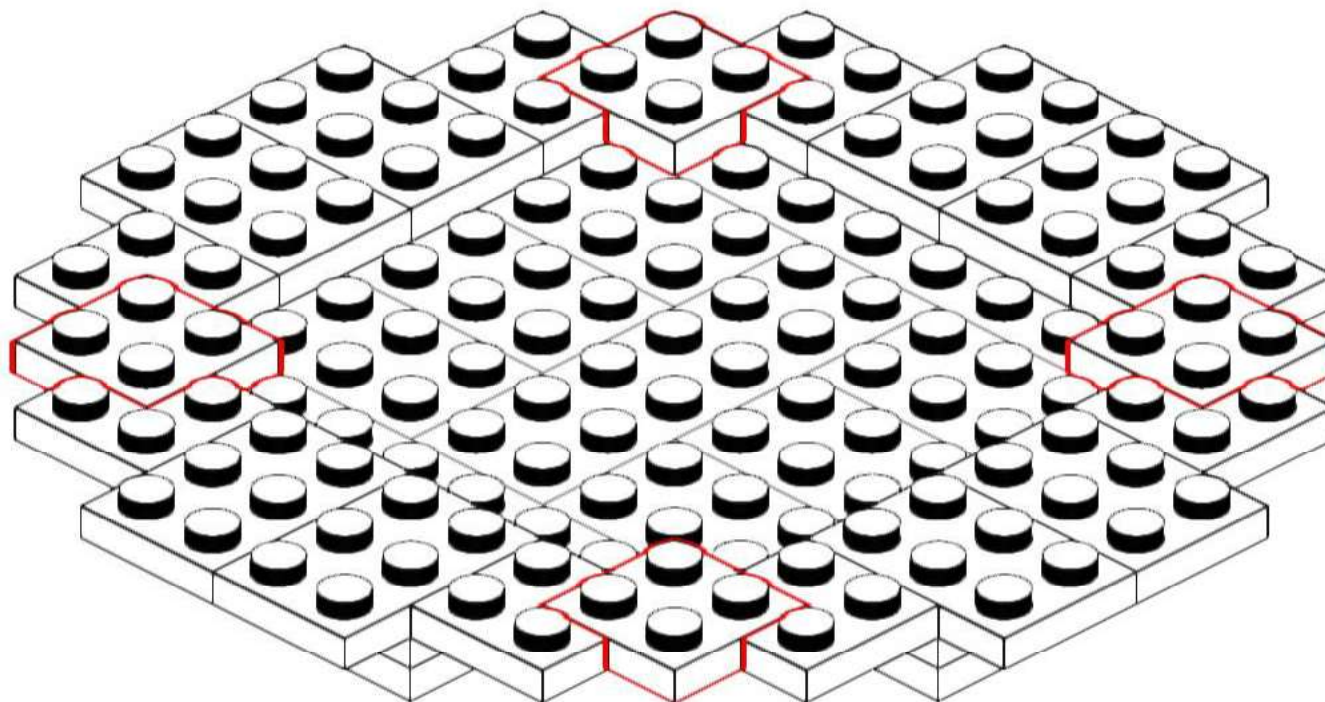
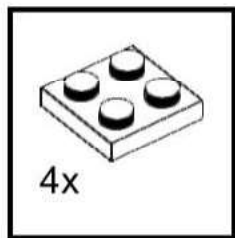

15

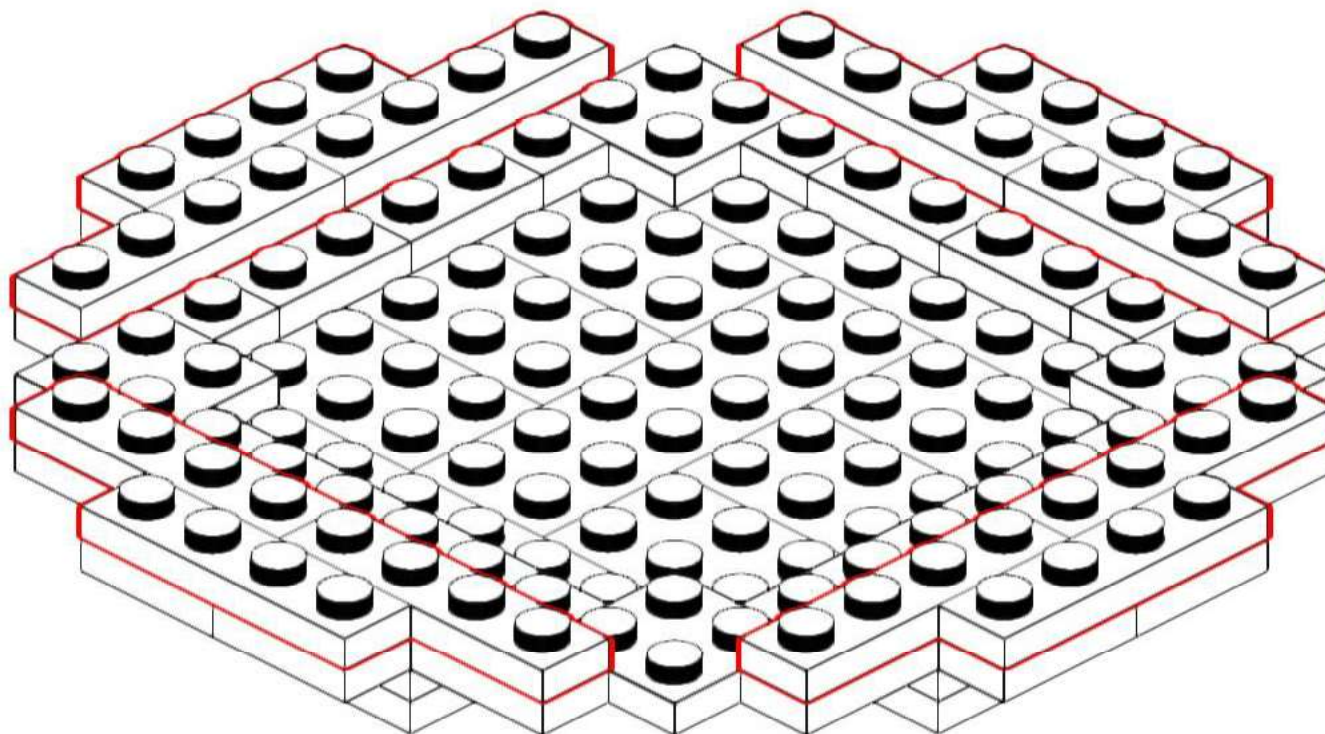
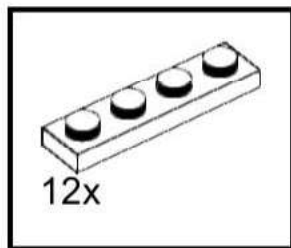

16

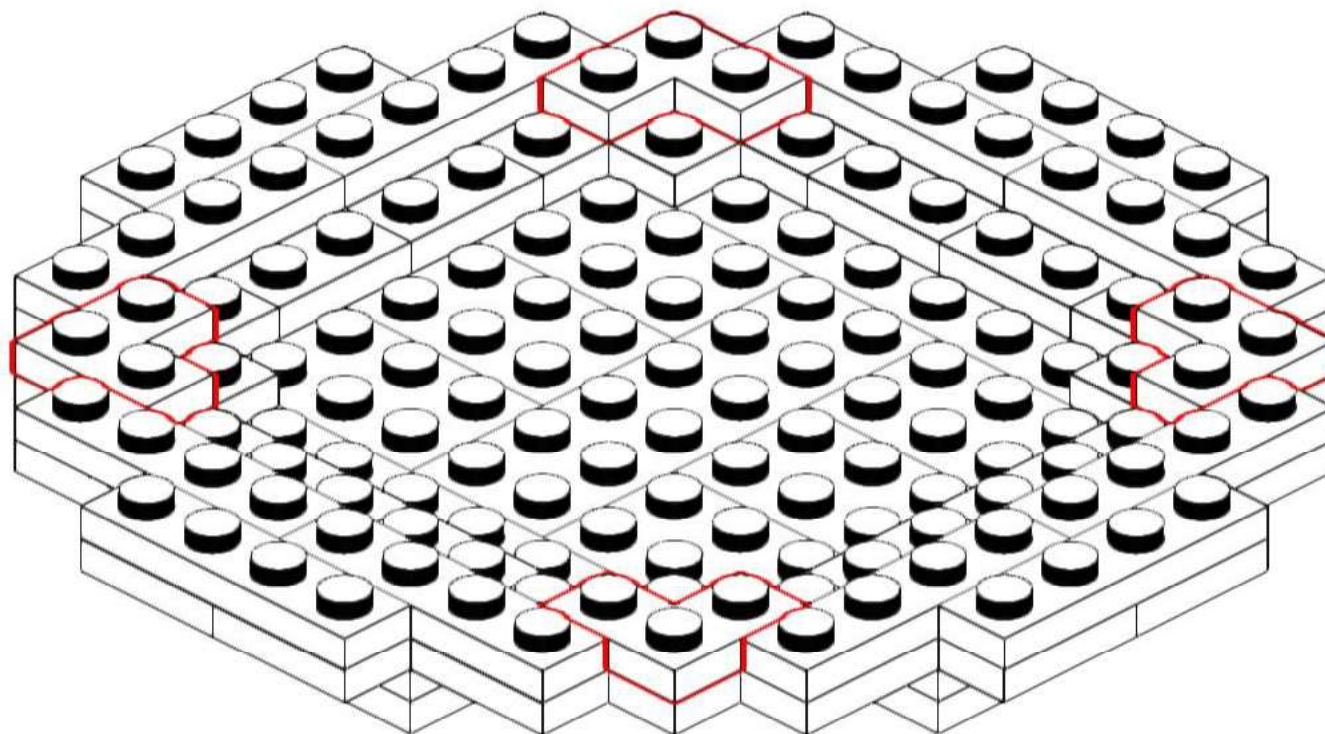
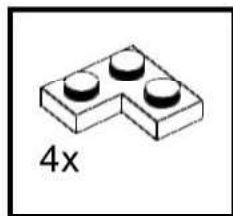

17

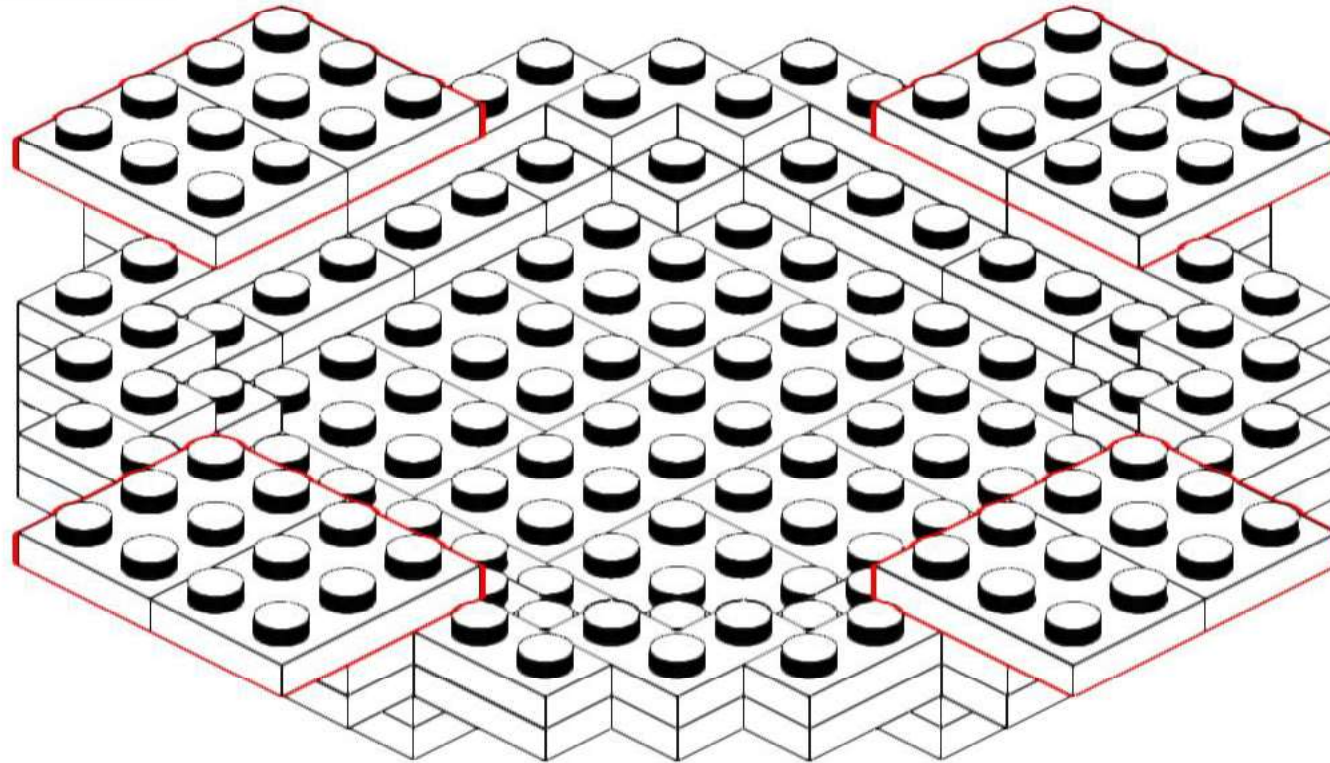
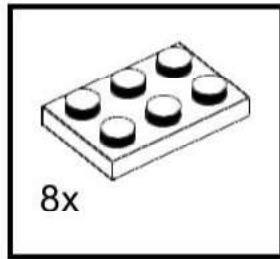

18

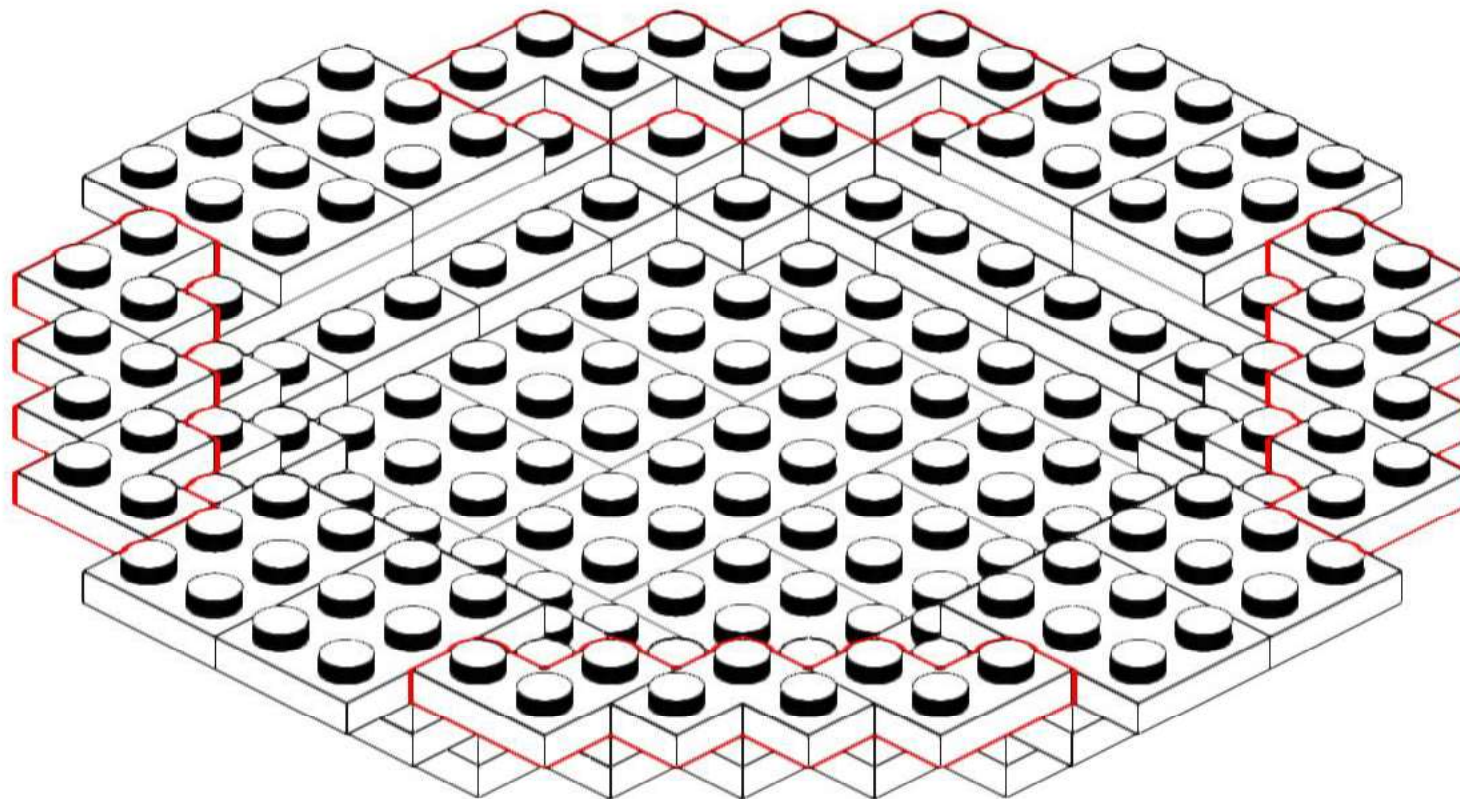
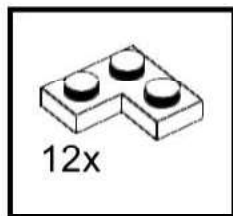

19

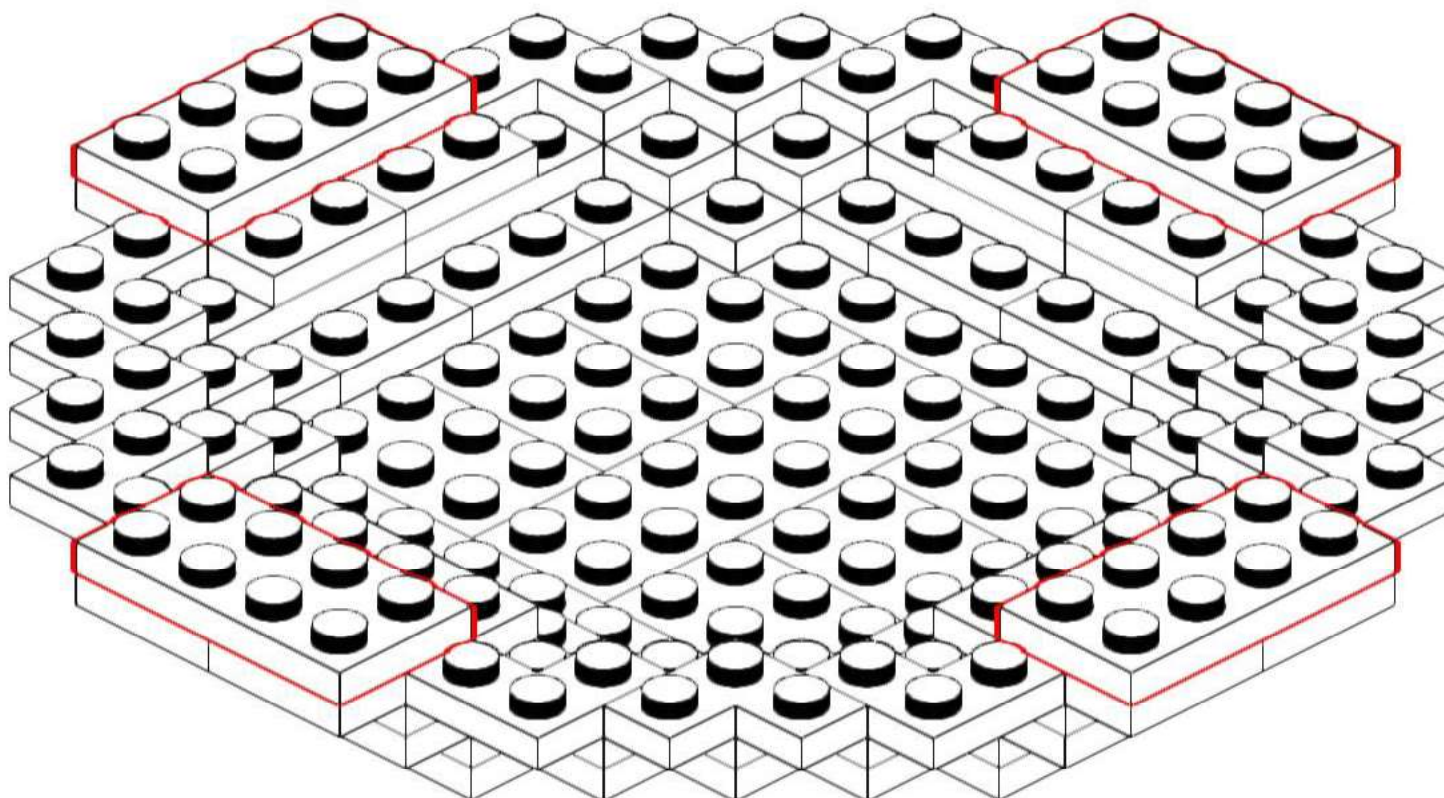
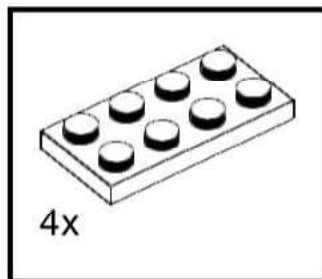

20

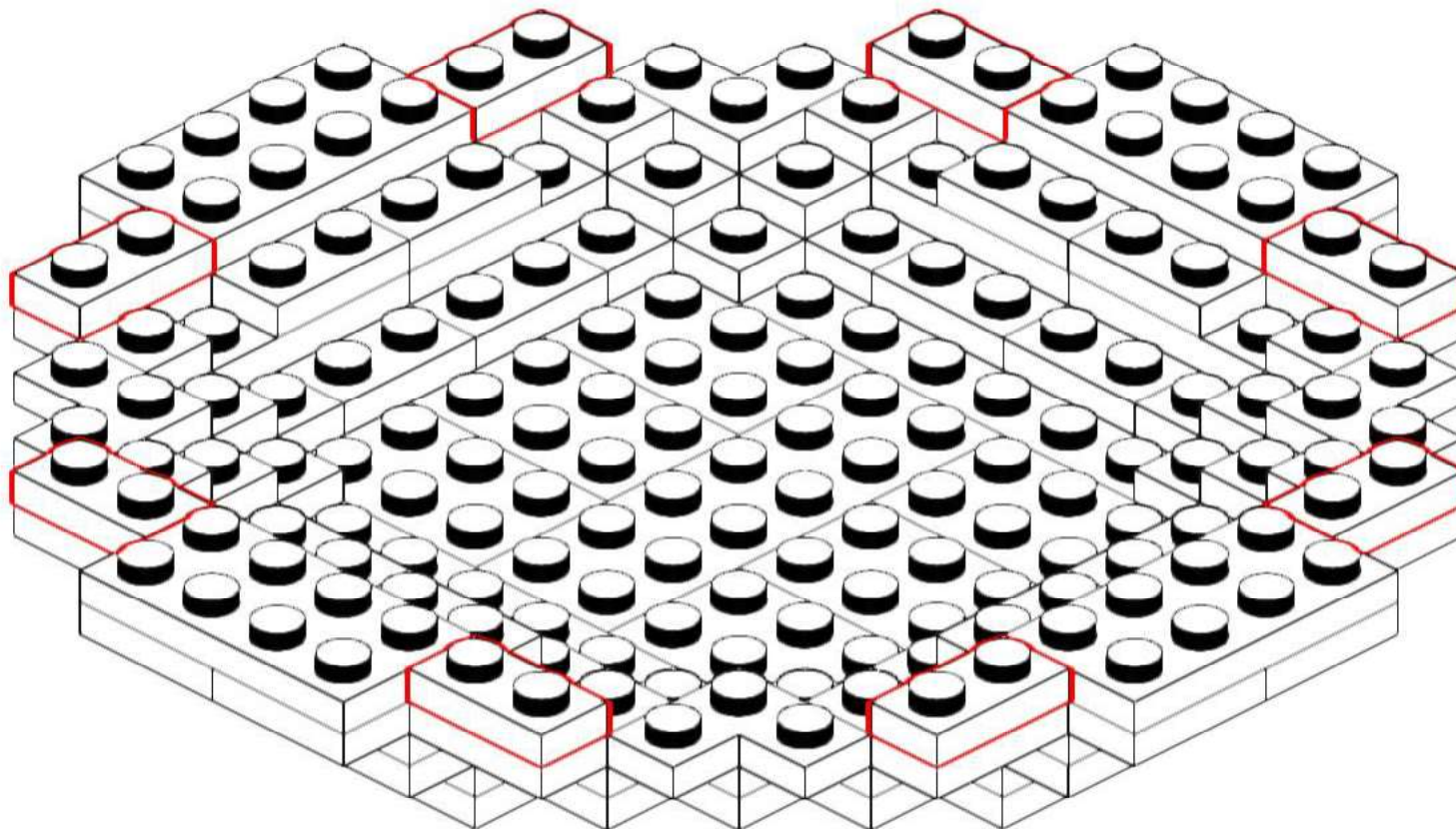
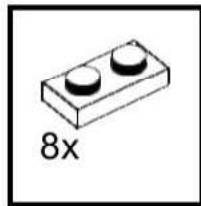

21

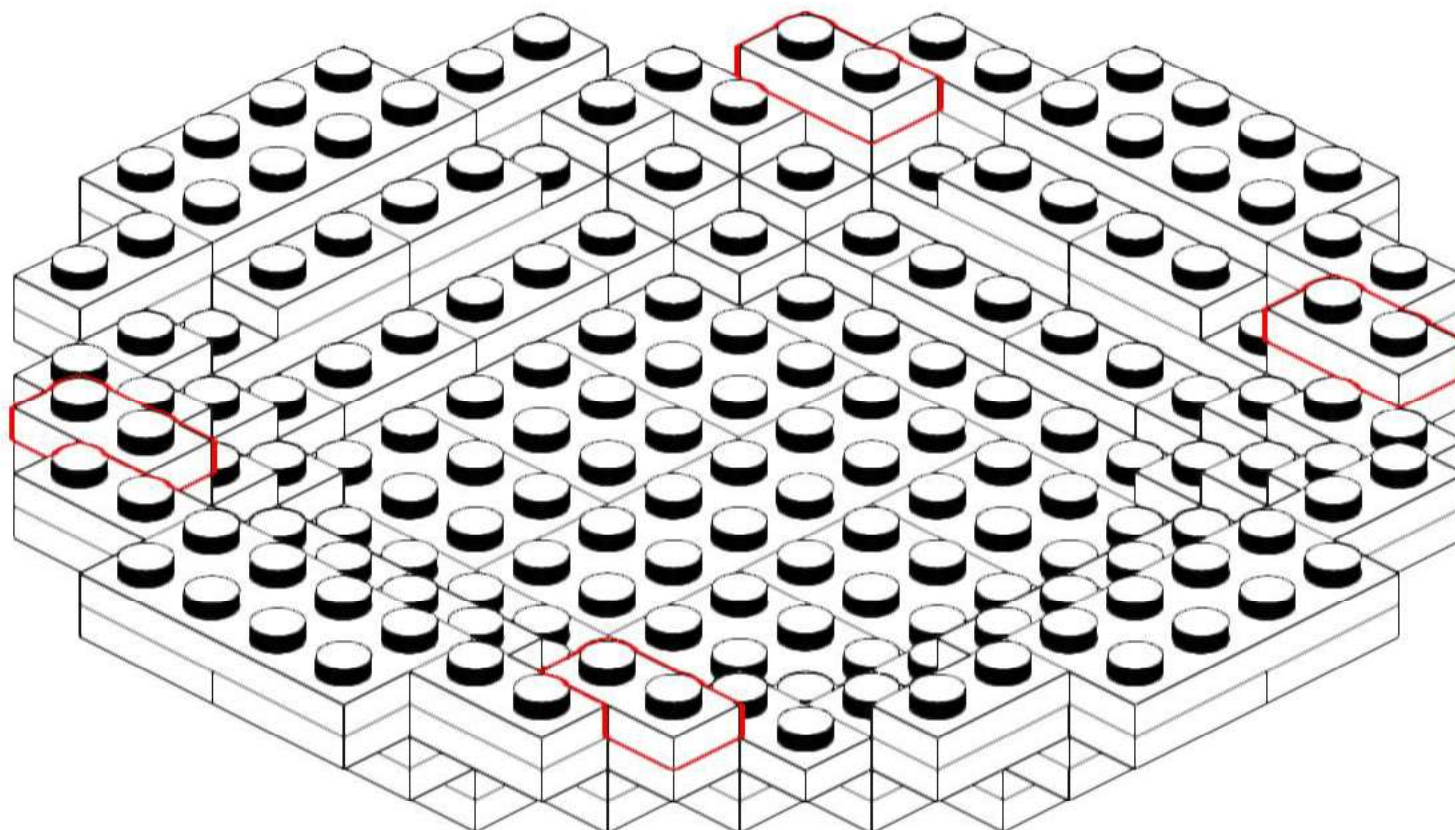
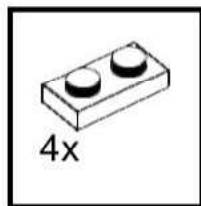

22

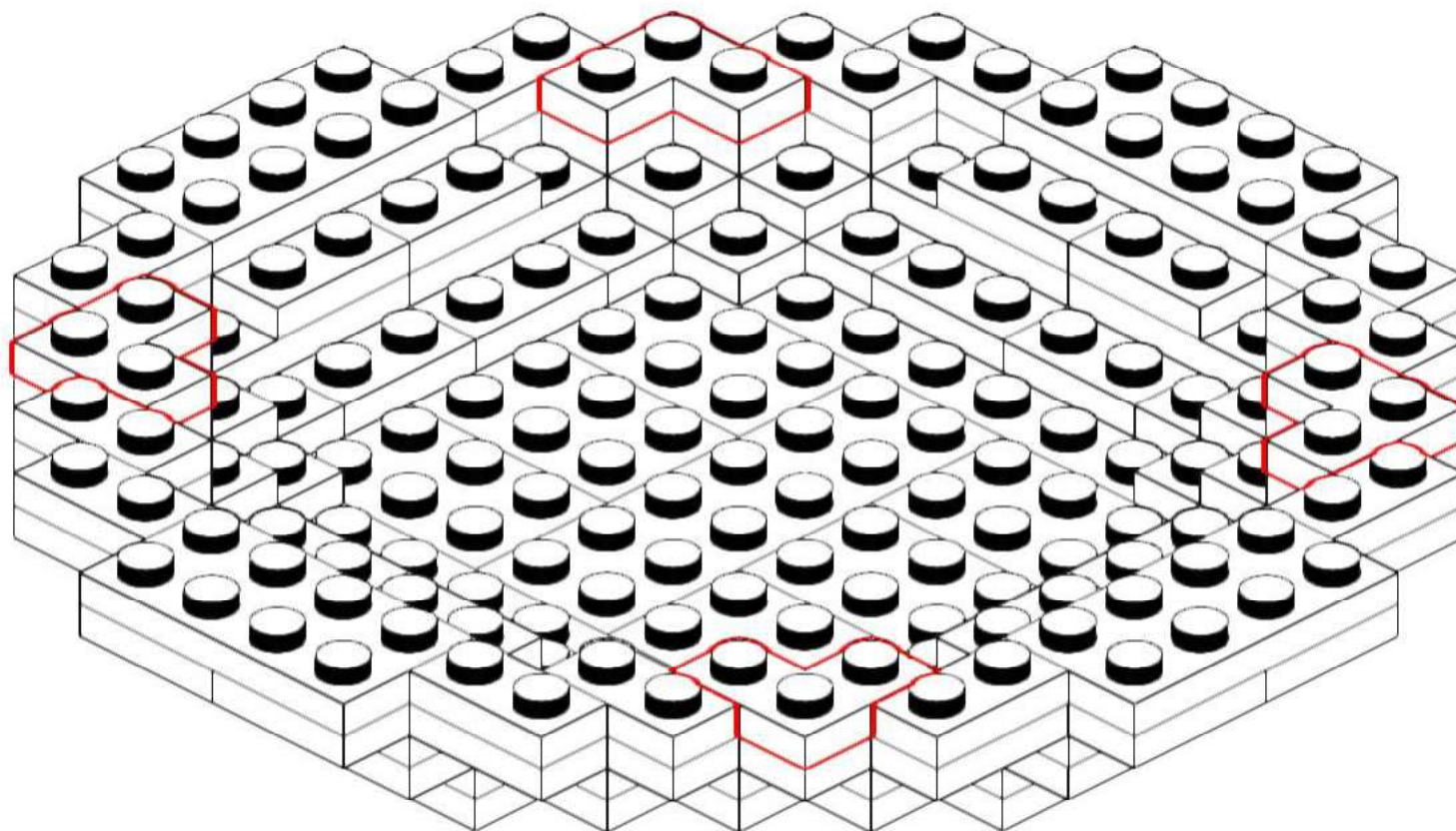
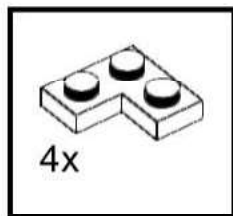

23

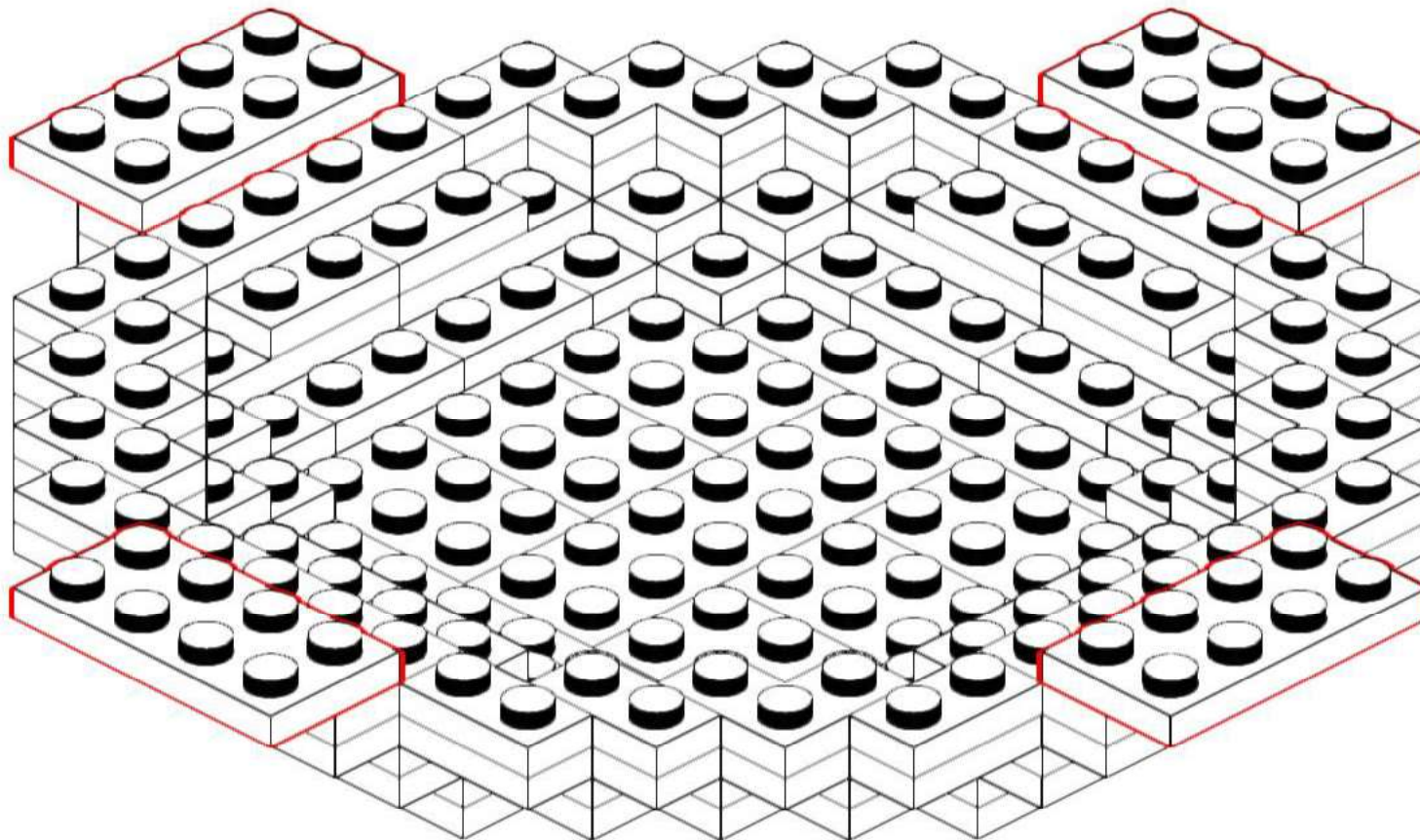
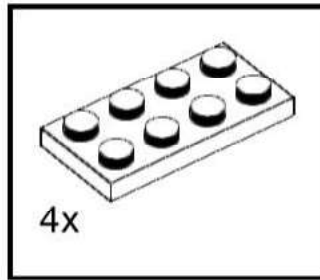

24

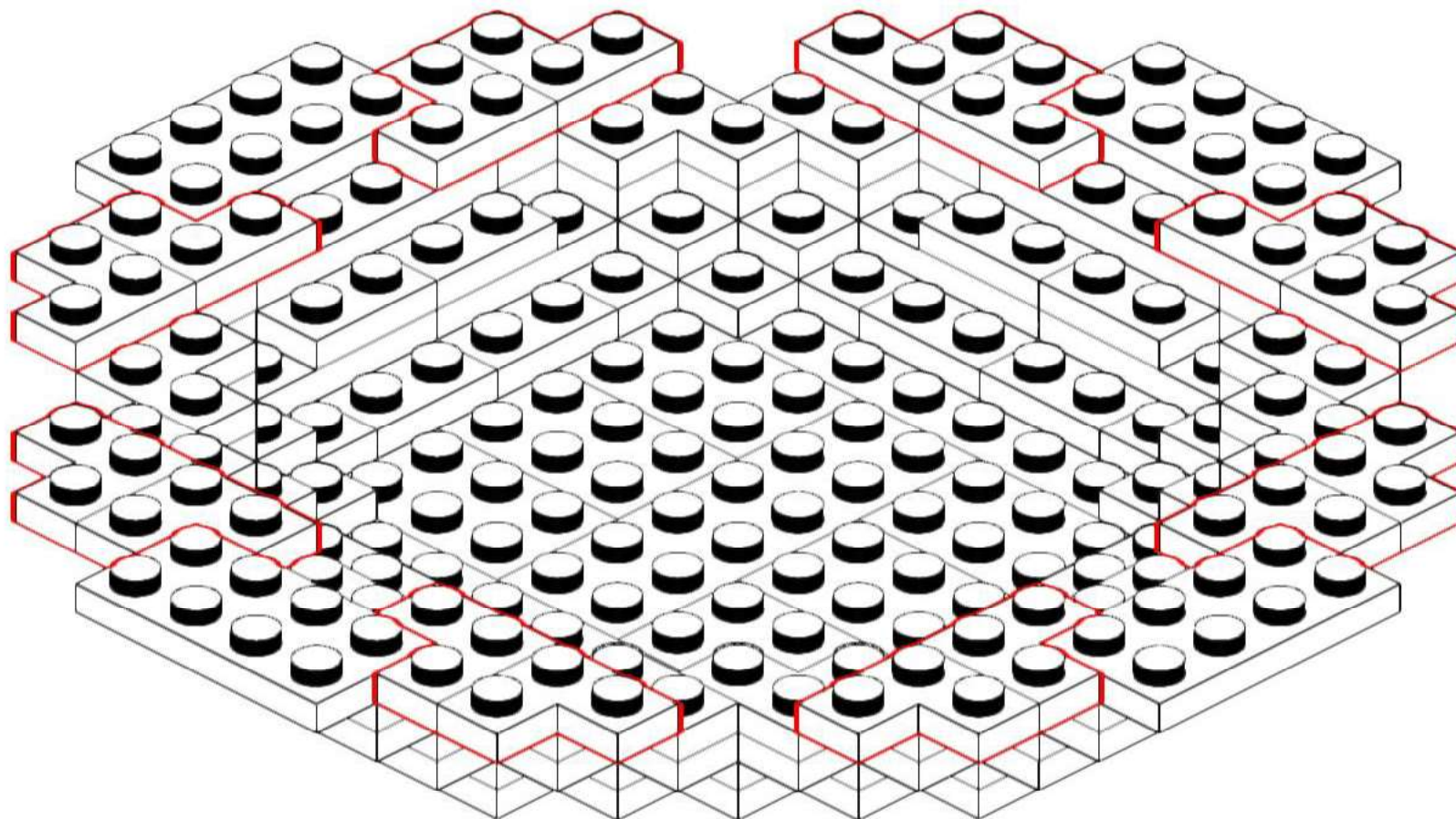
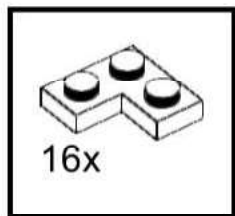

25

EF

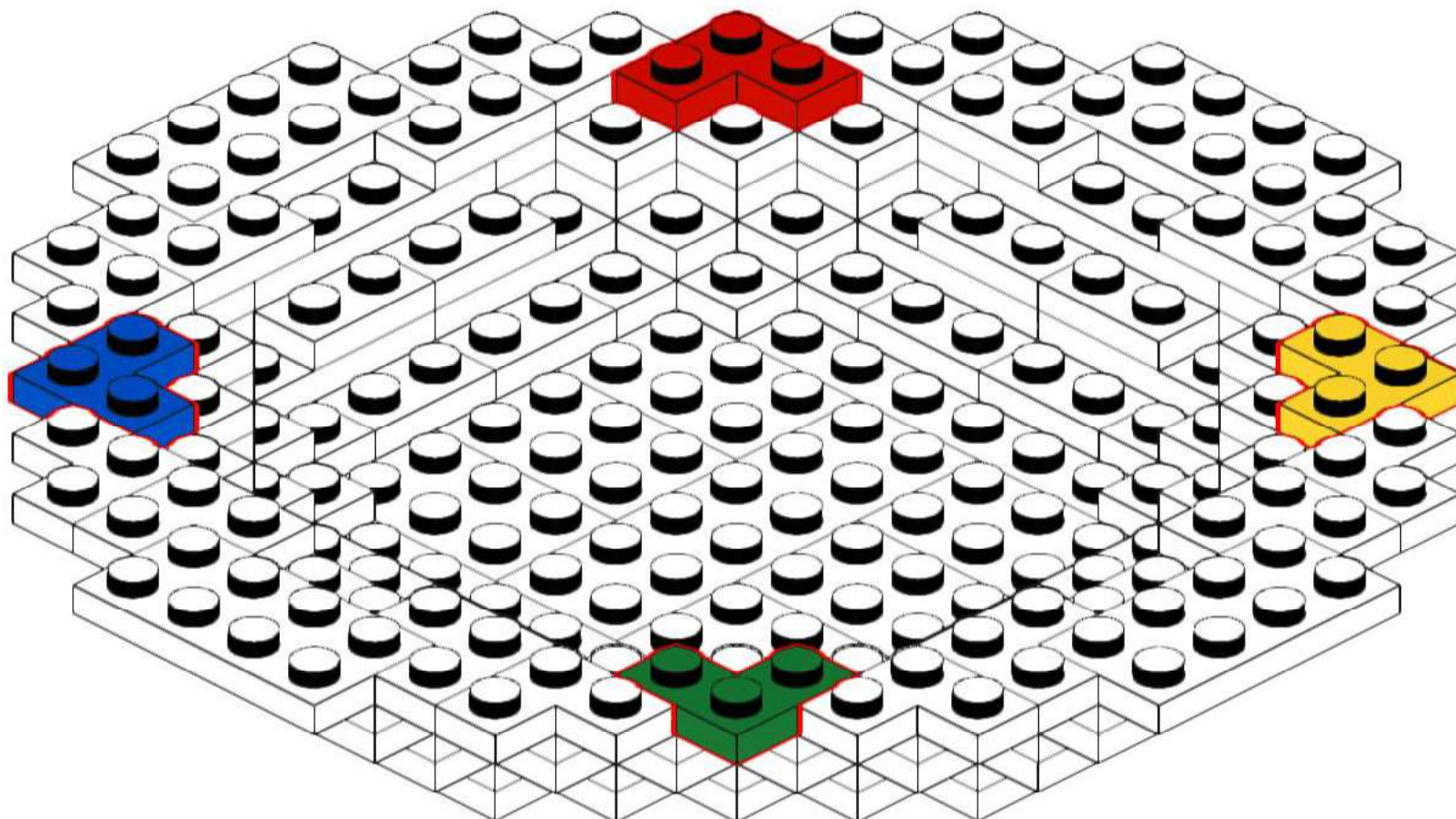
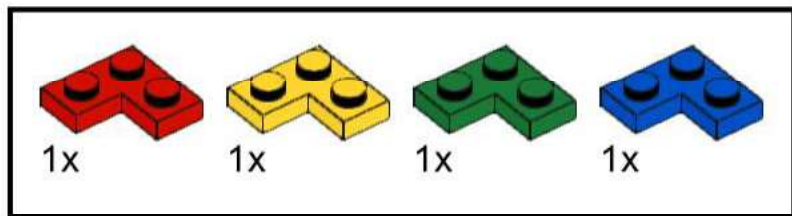

26

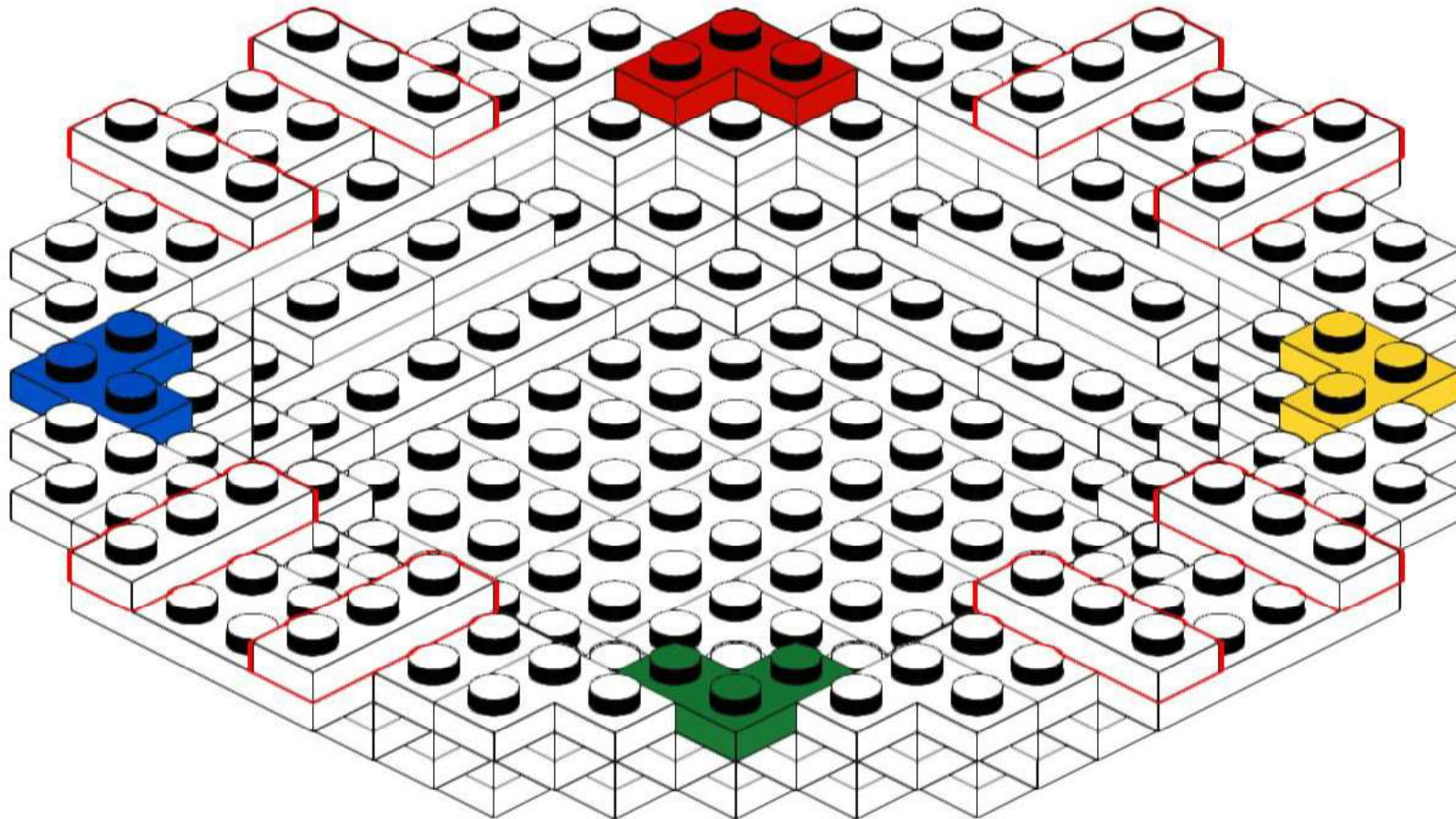
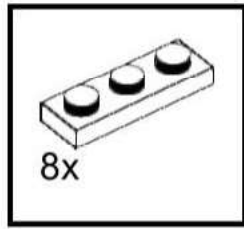

27

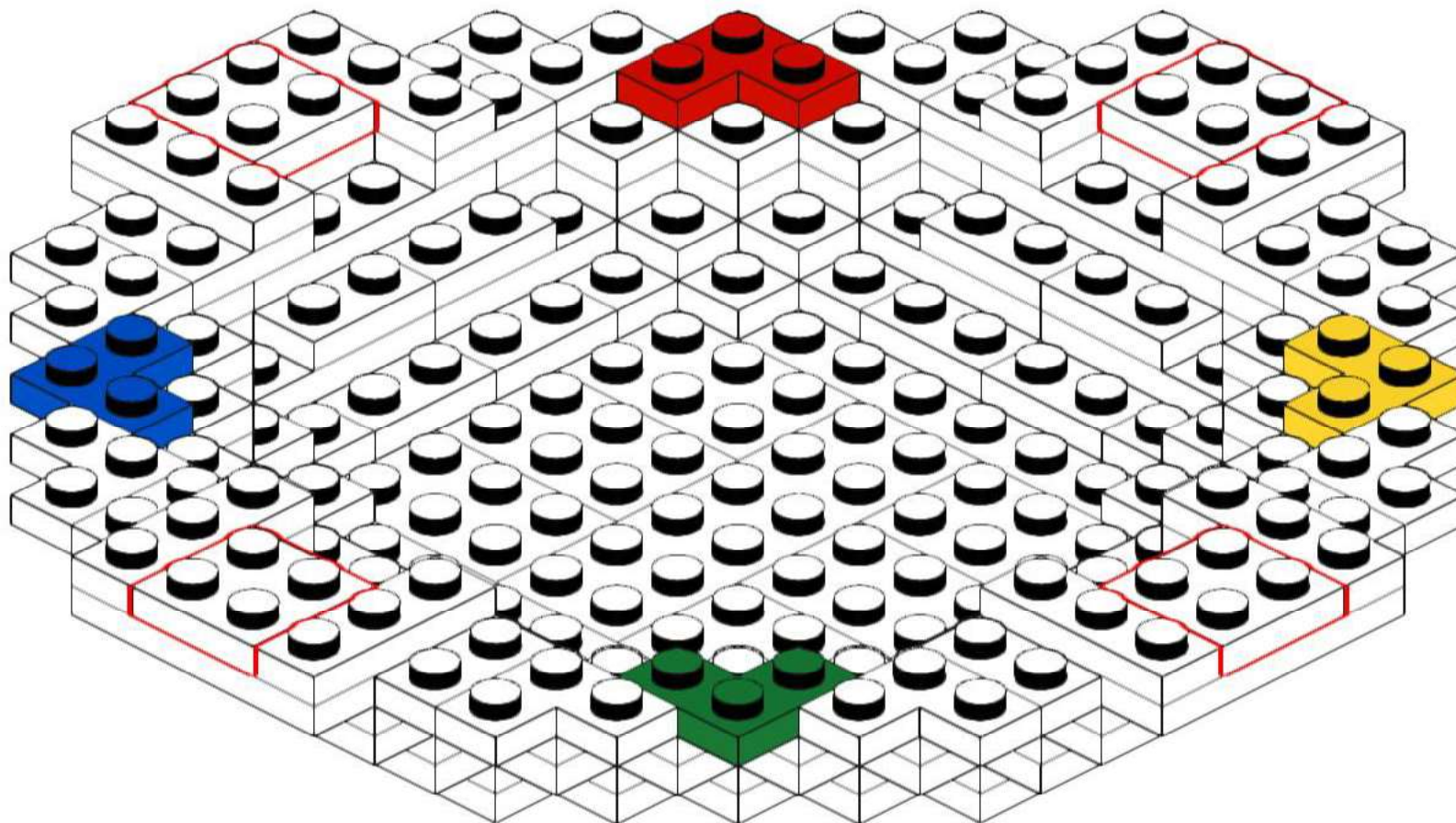
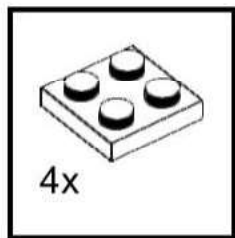

28

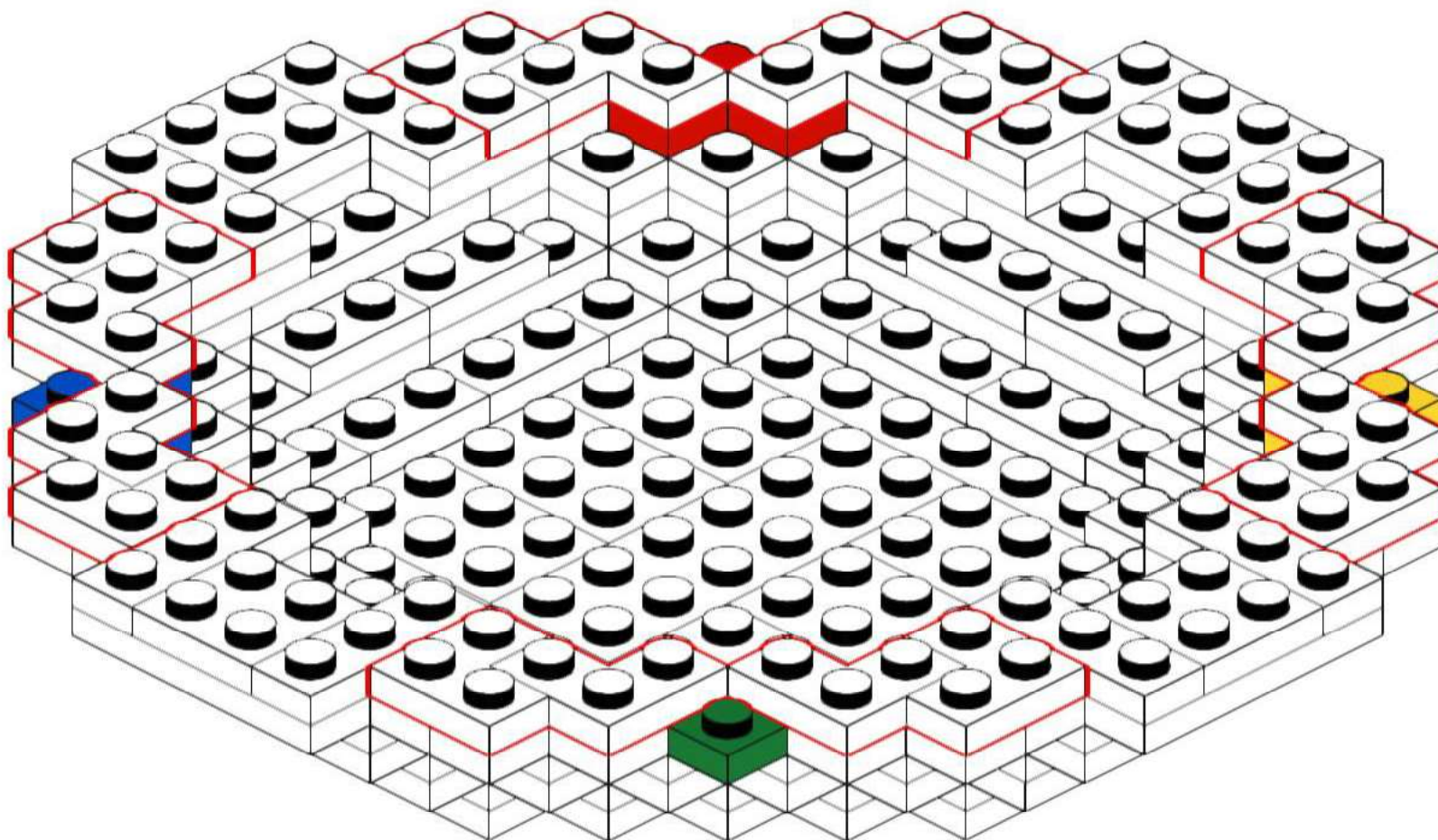
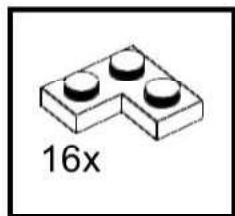

29

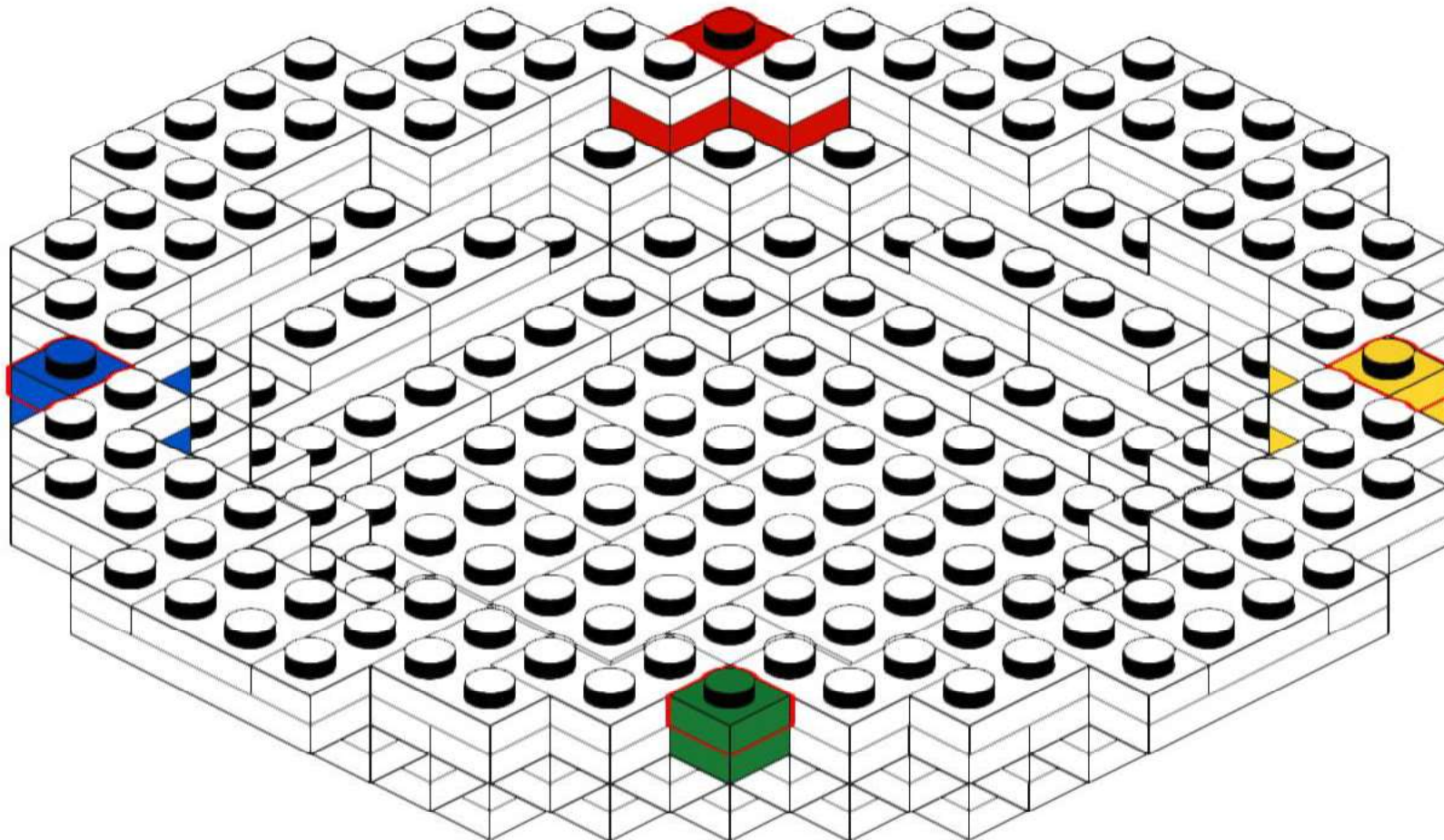
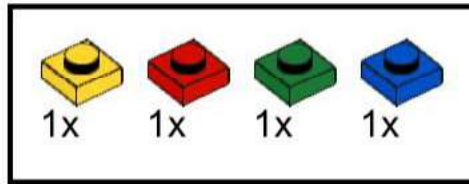

30

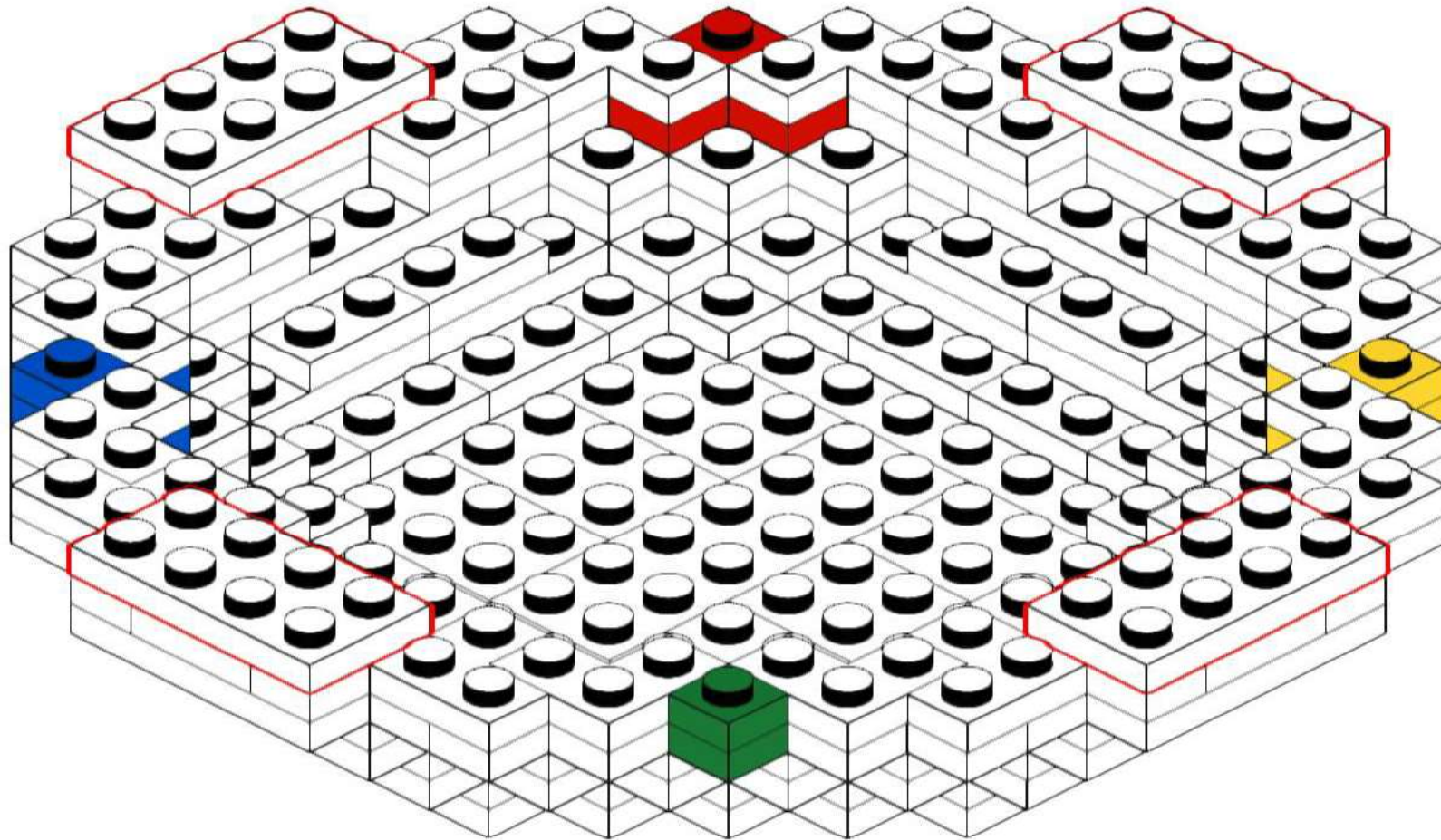
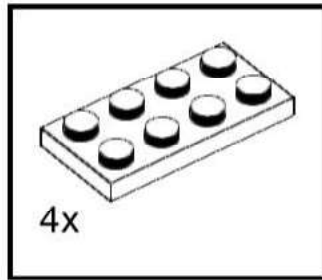

31

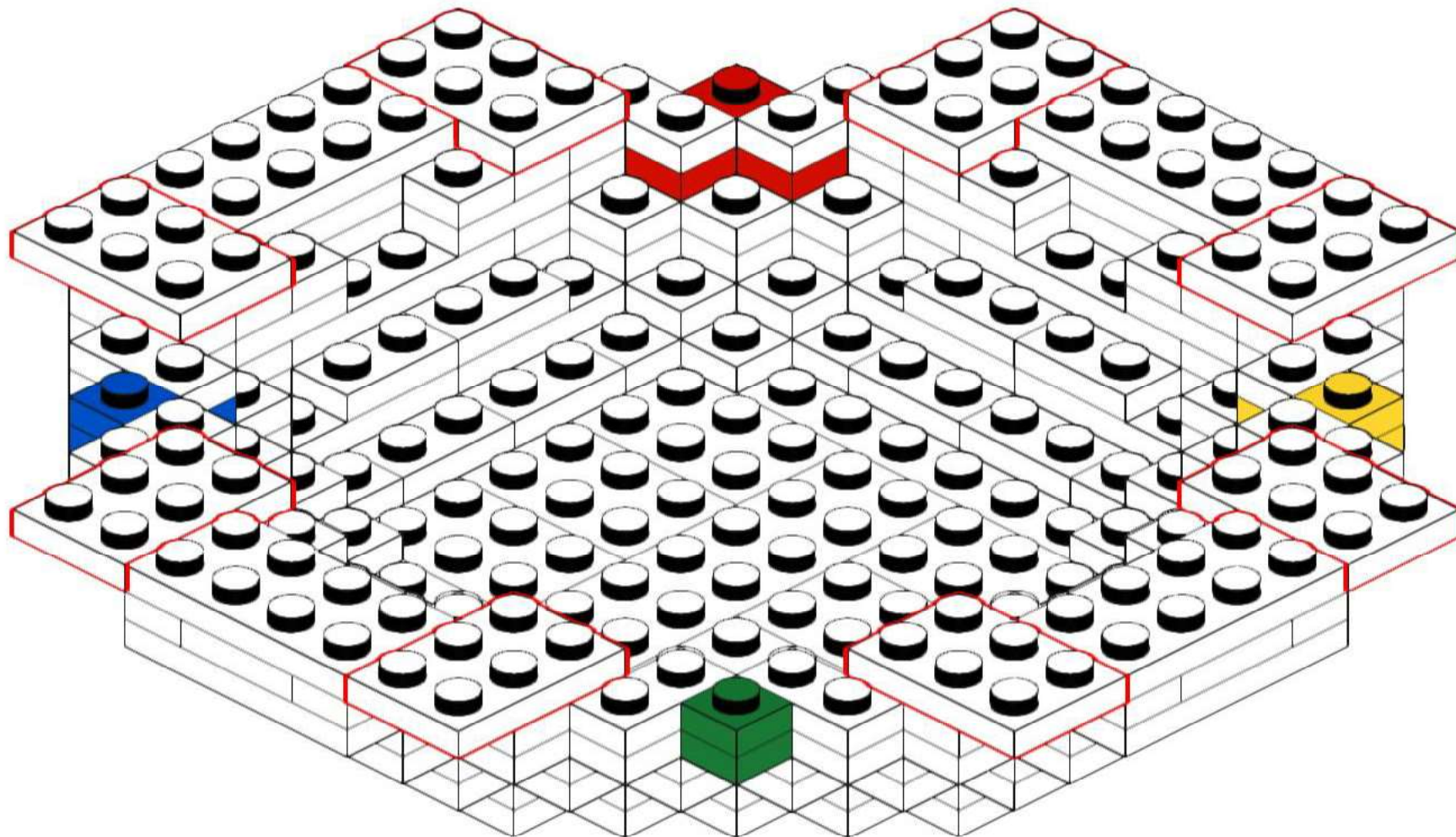
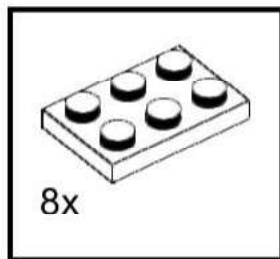

32

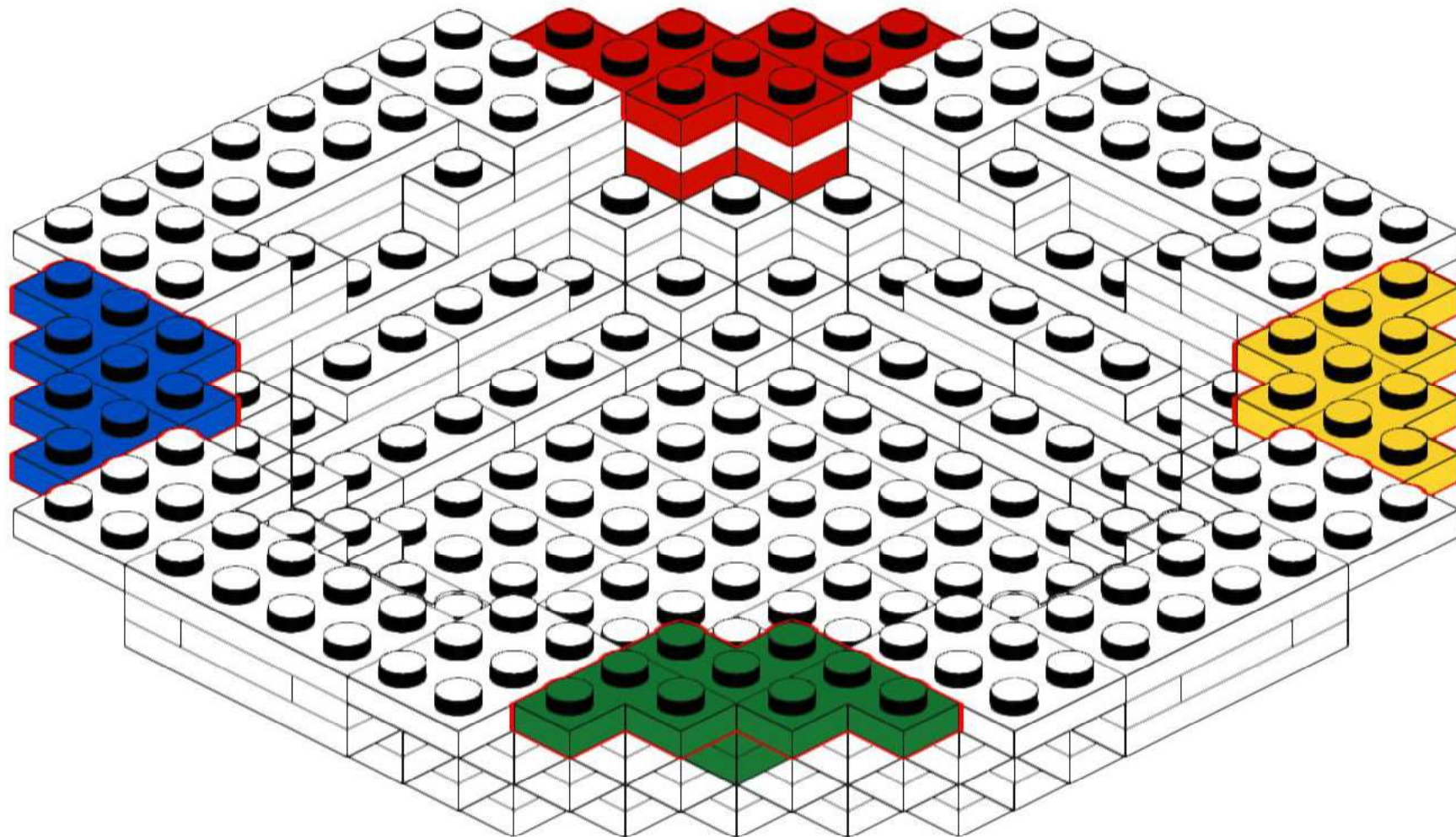
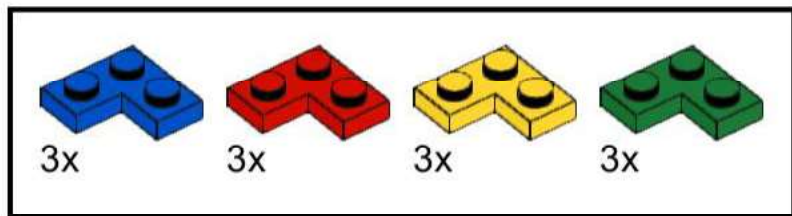

33

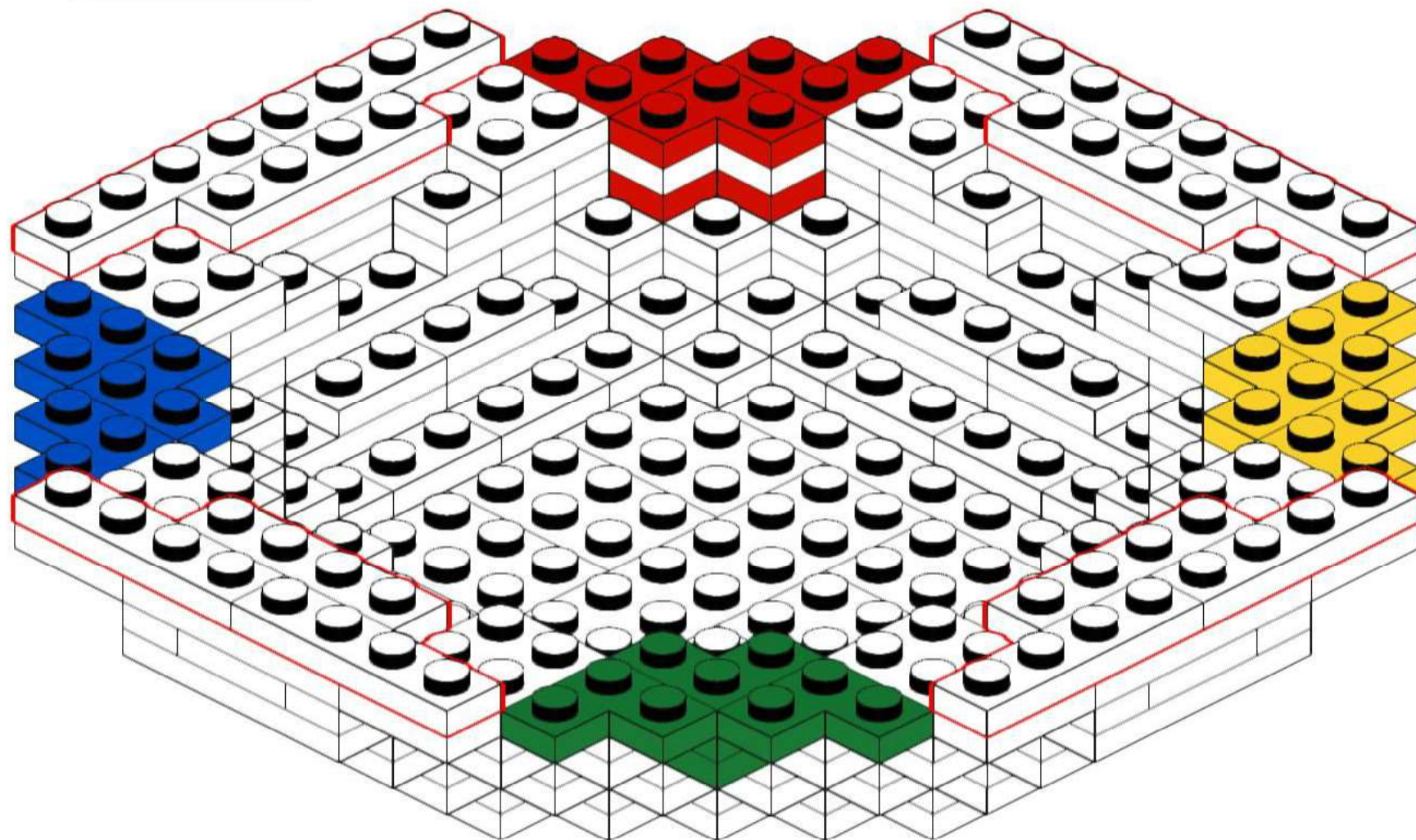
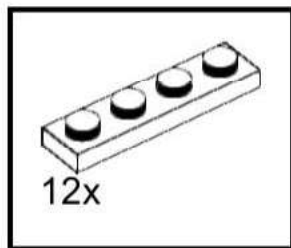

34

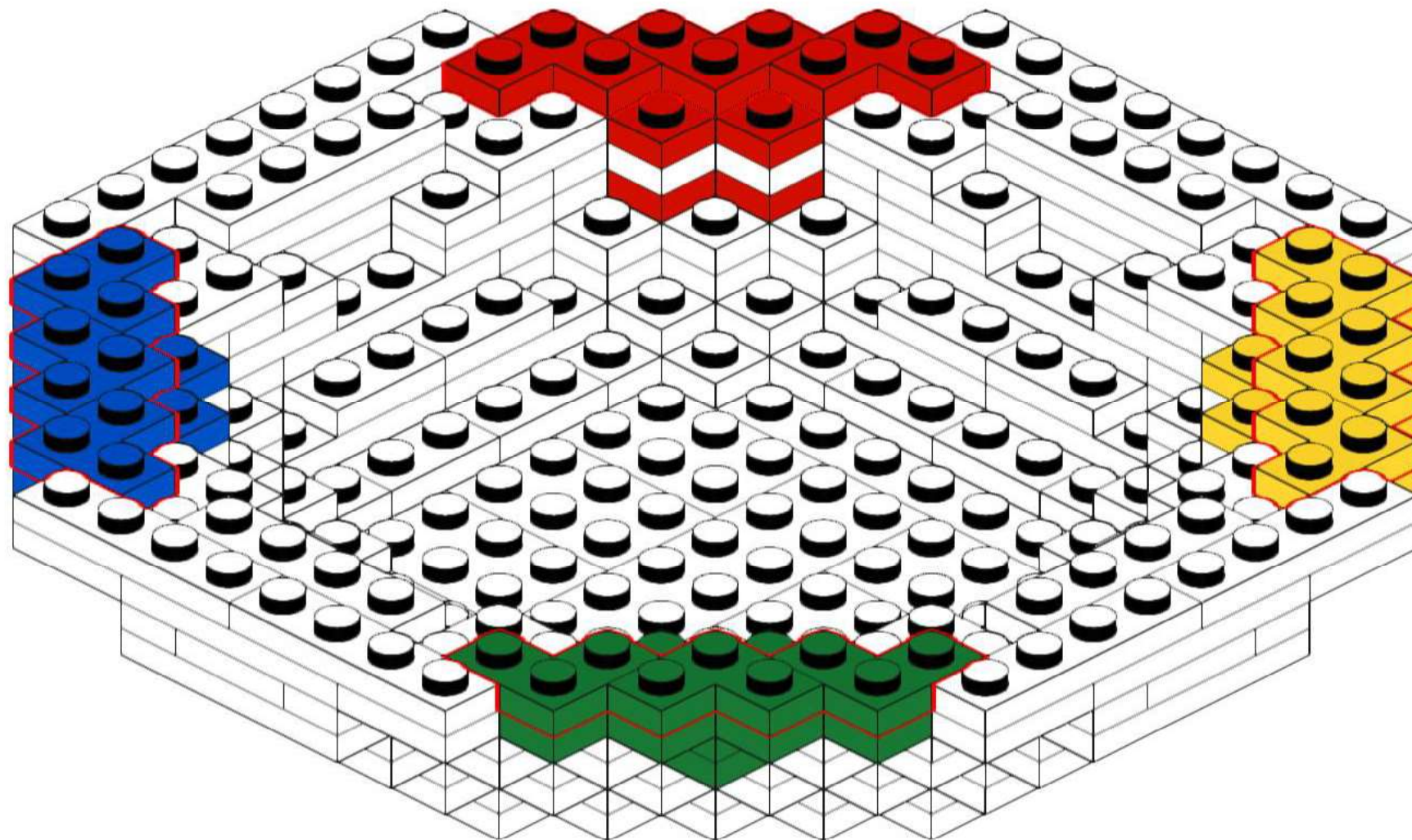
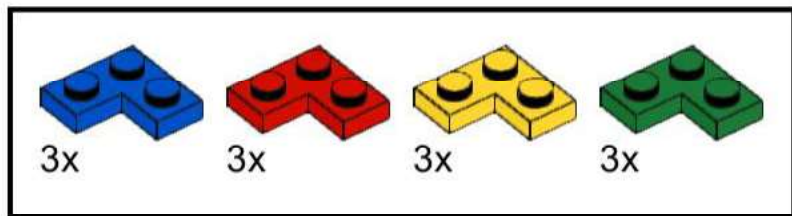

35

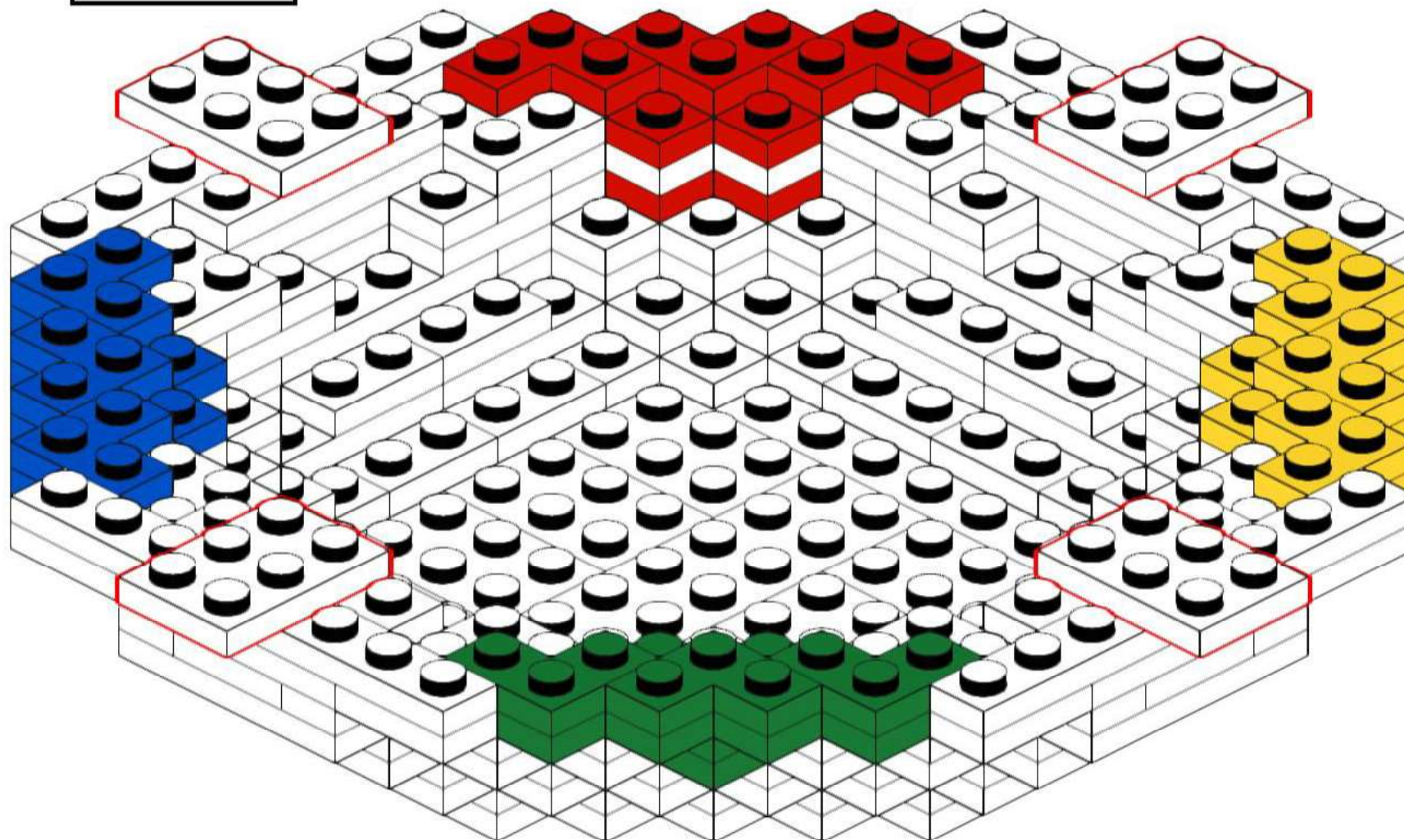
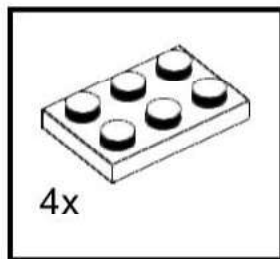

36

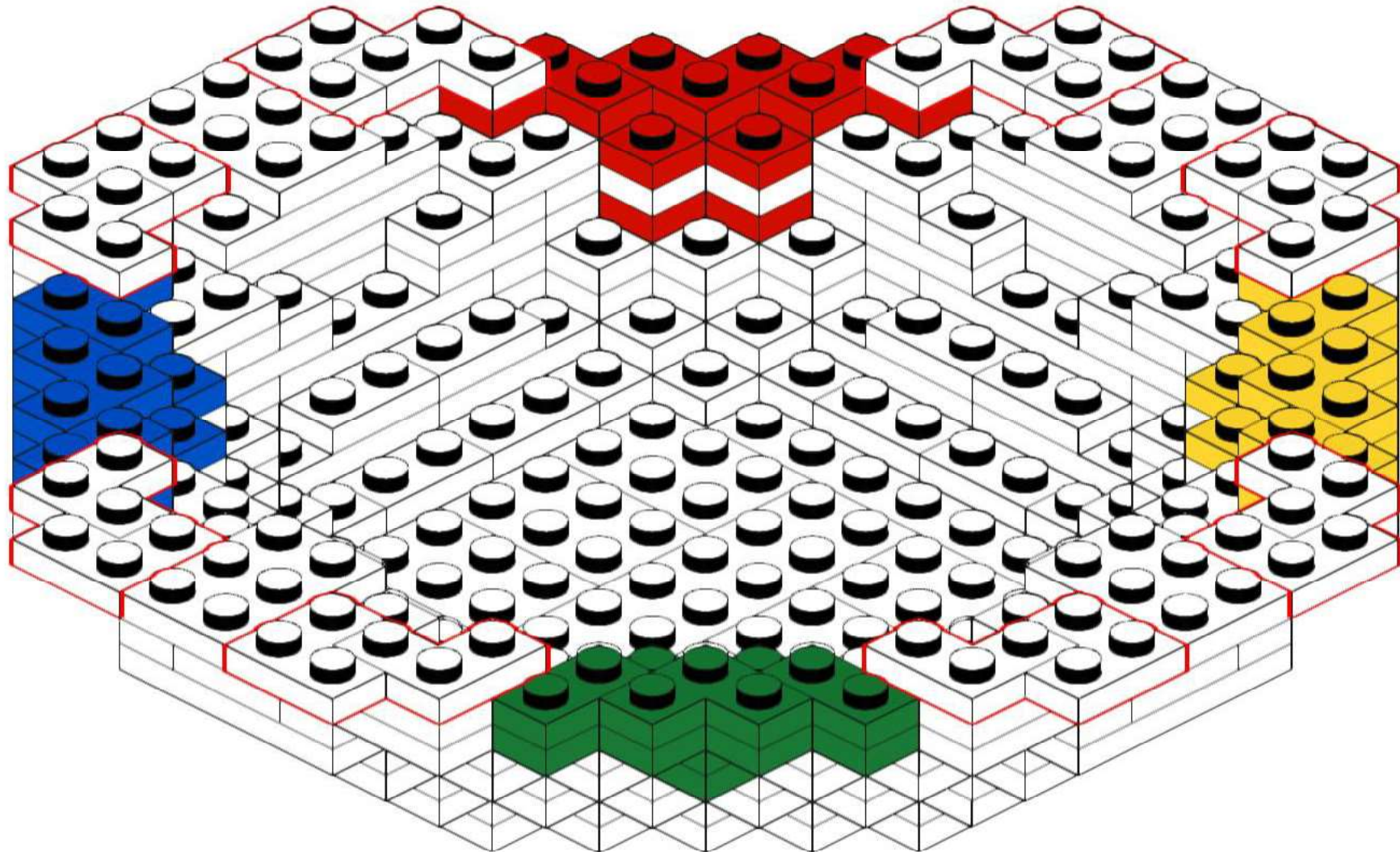
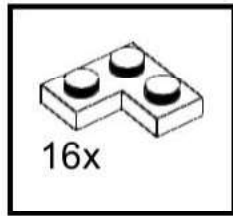

37

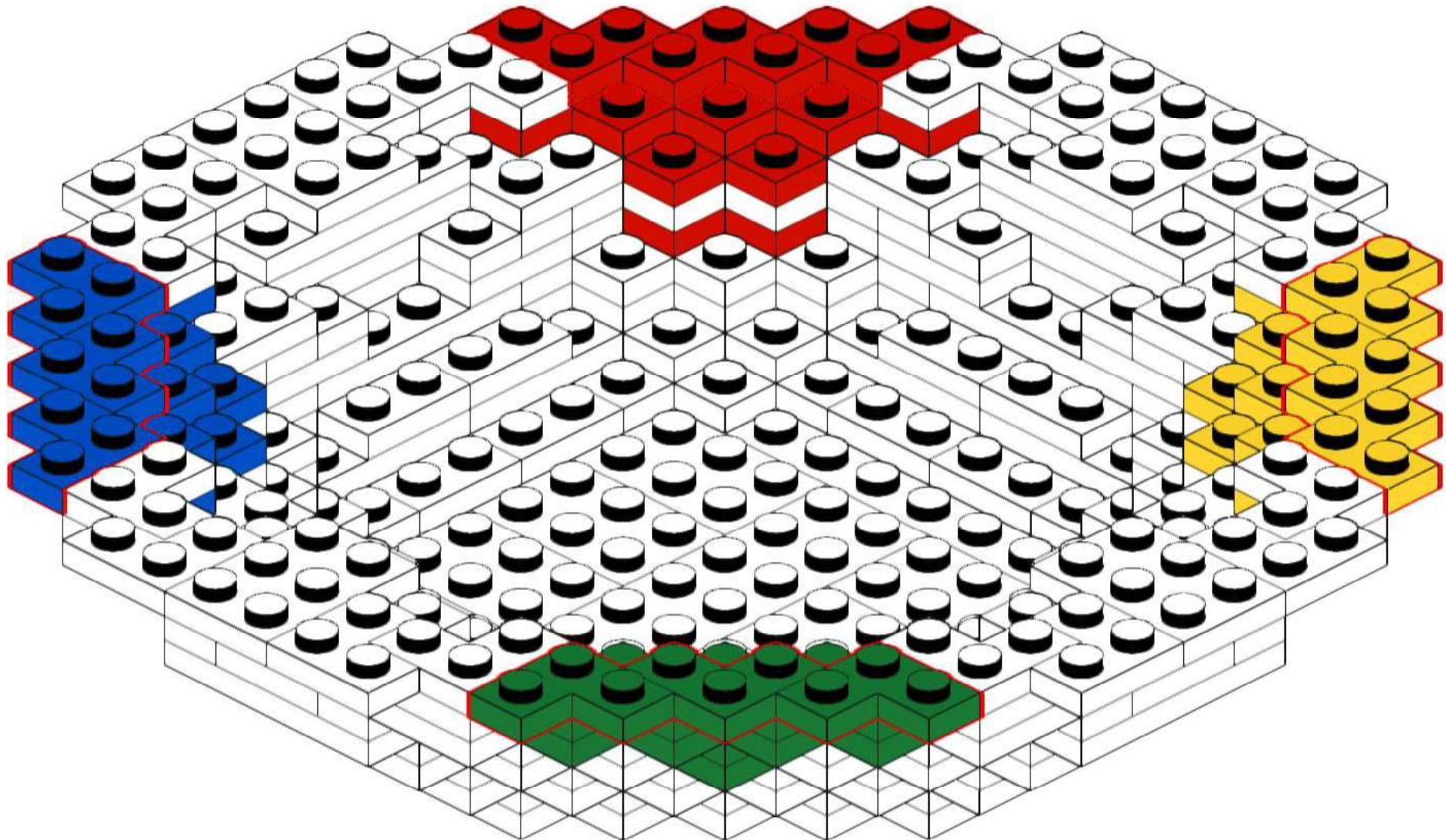
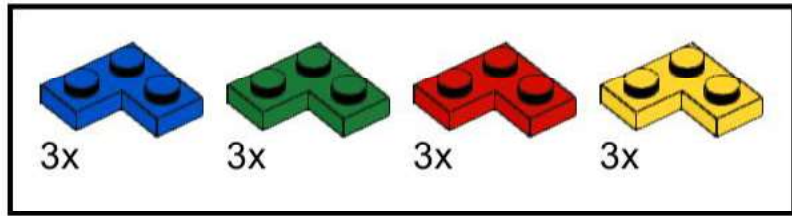

38

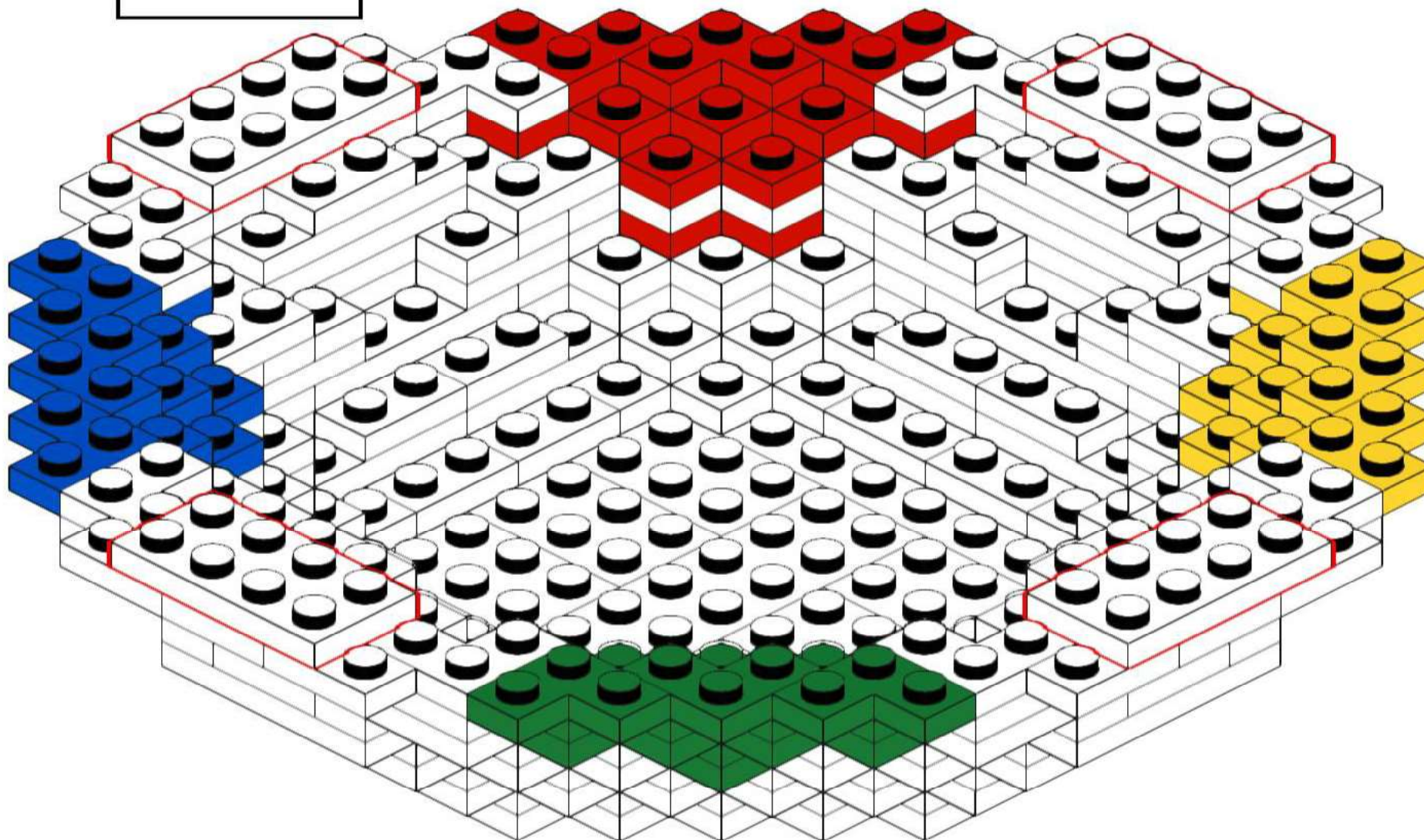
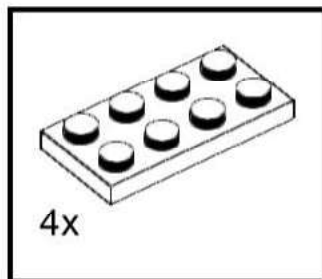

39

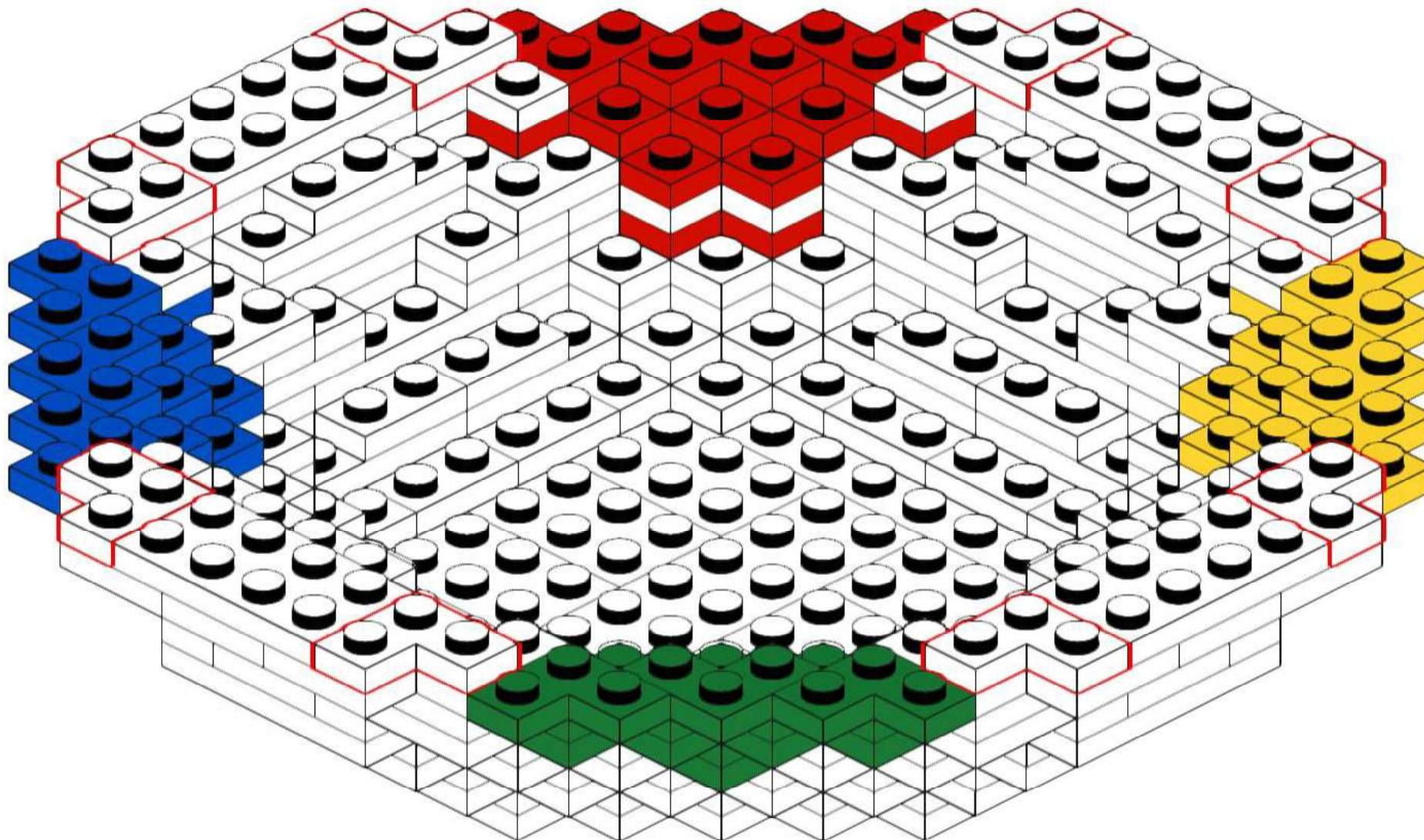
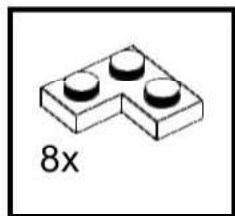

40

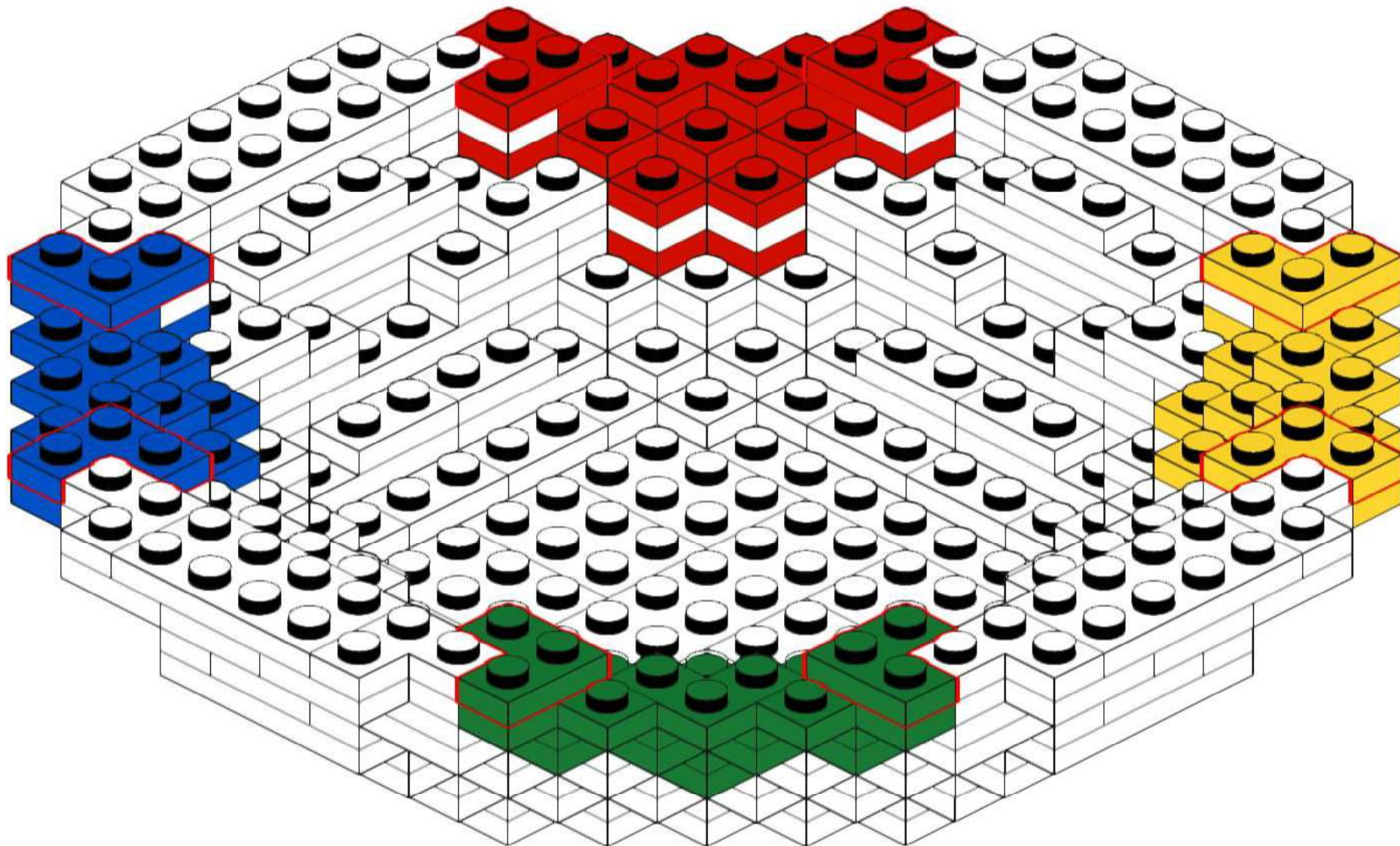
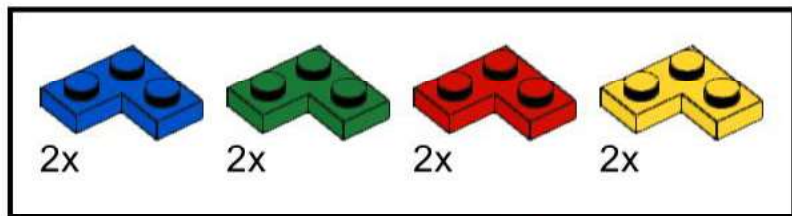

41

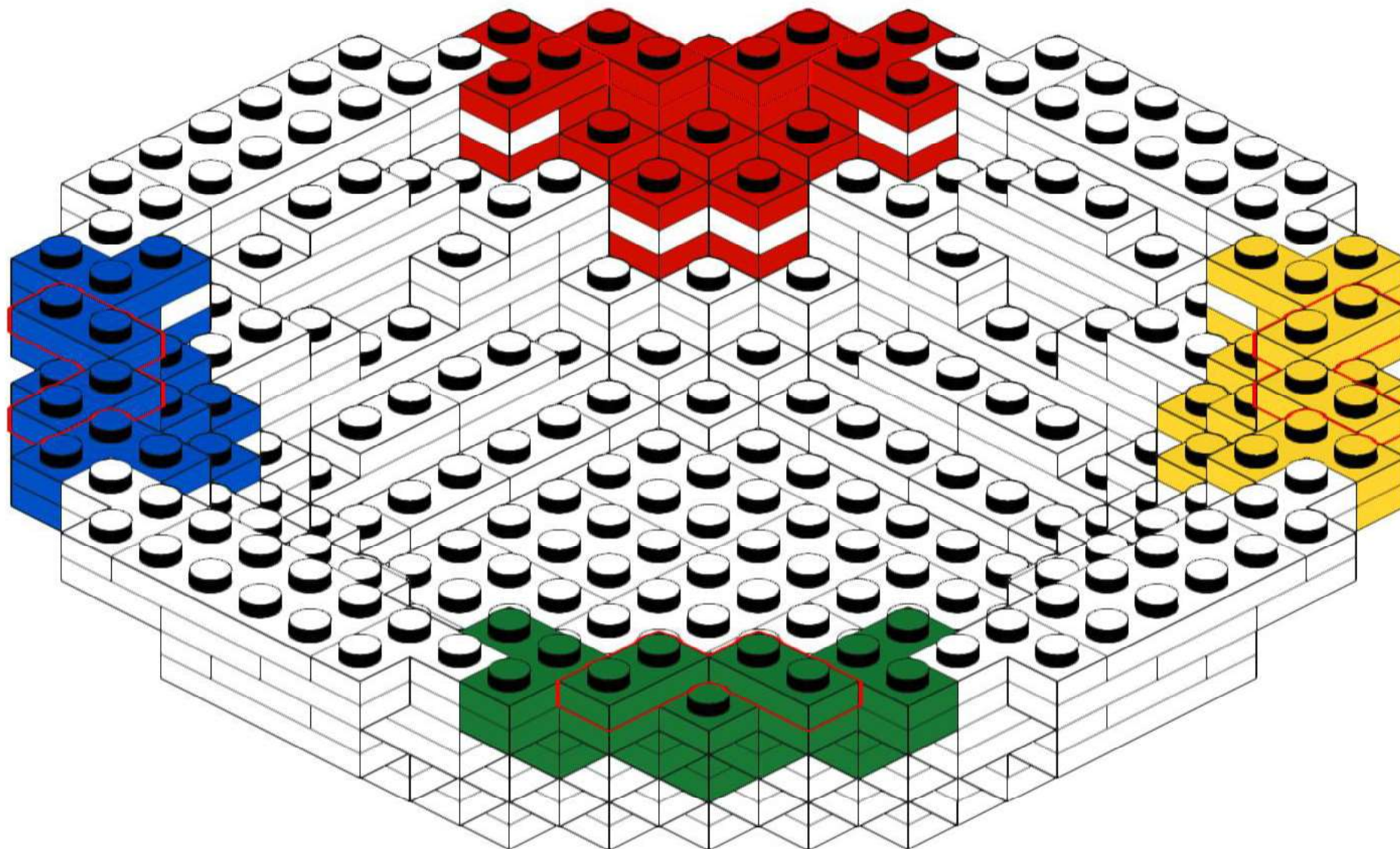
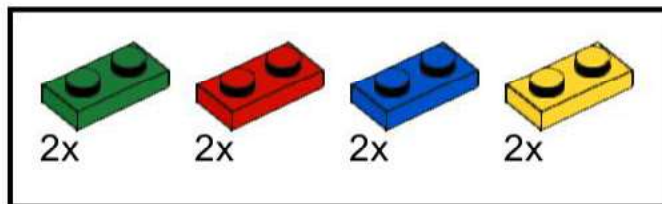

42

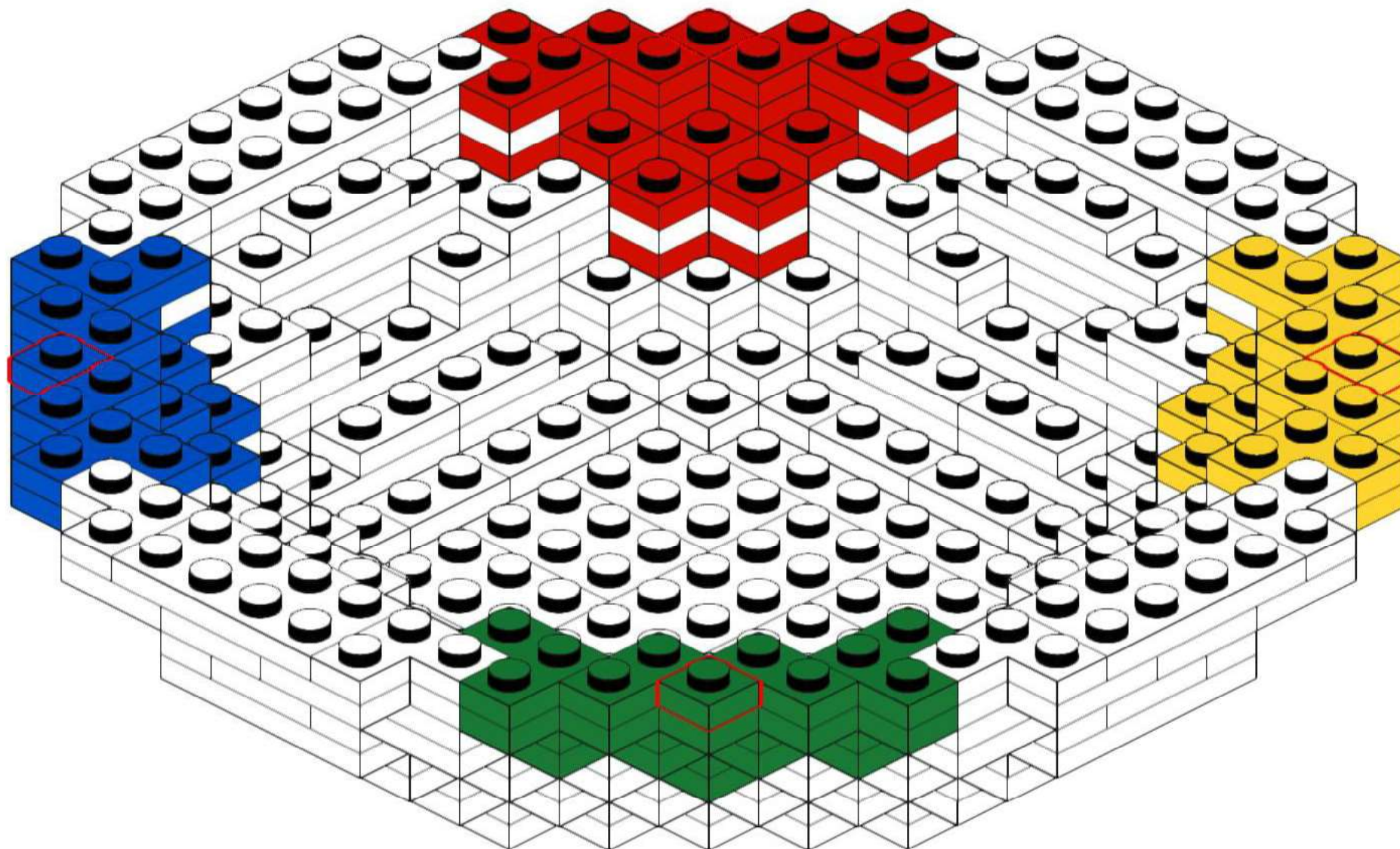
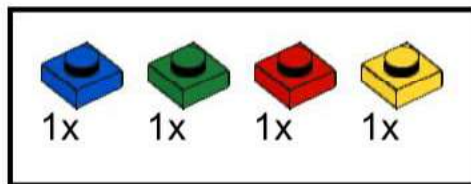

43

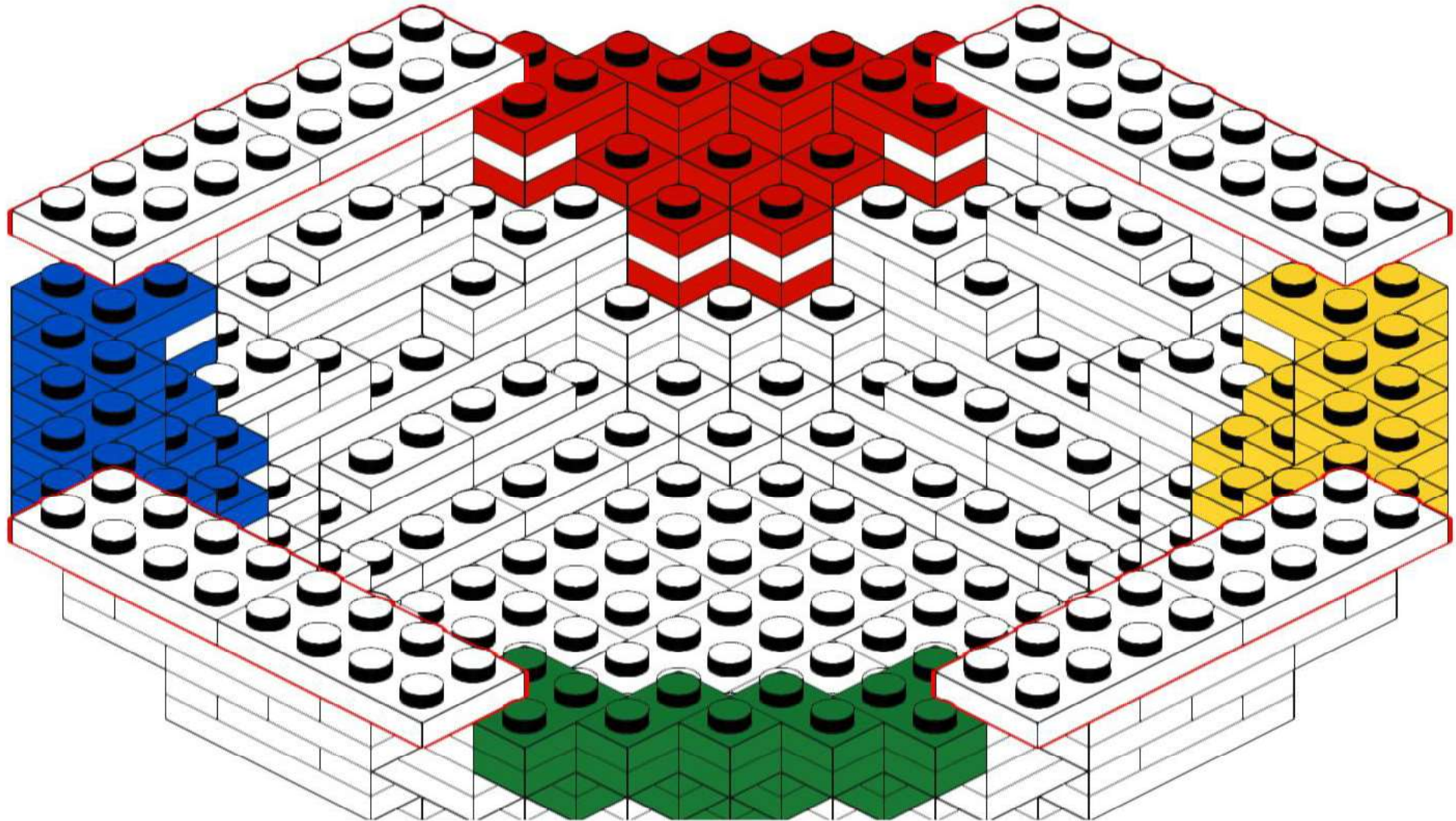
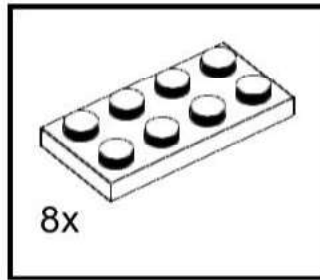

44

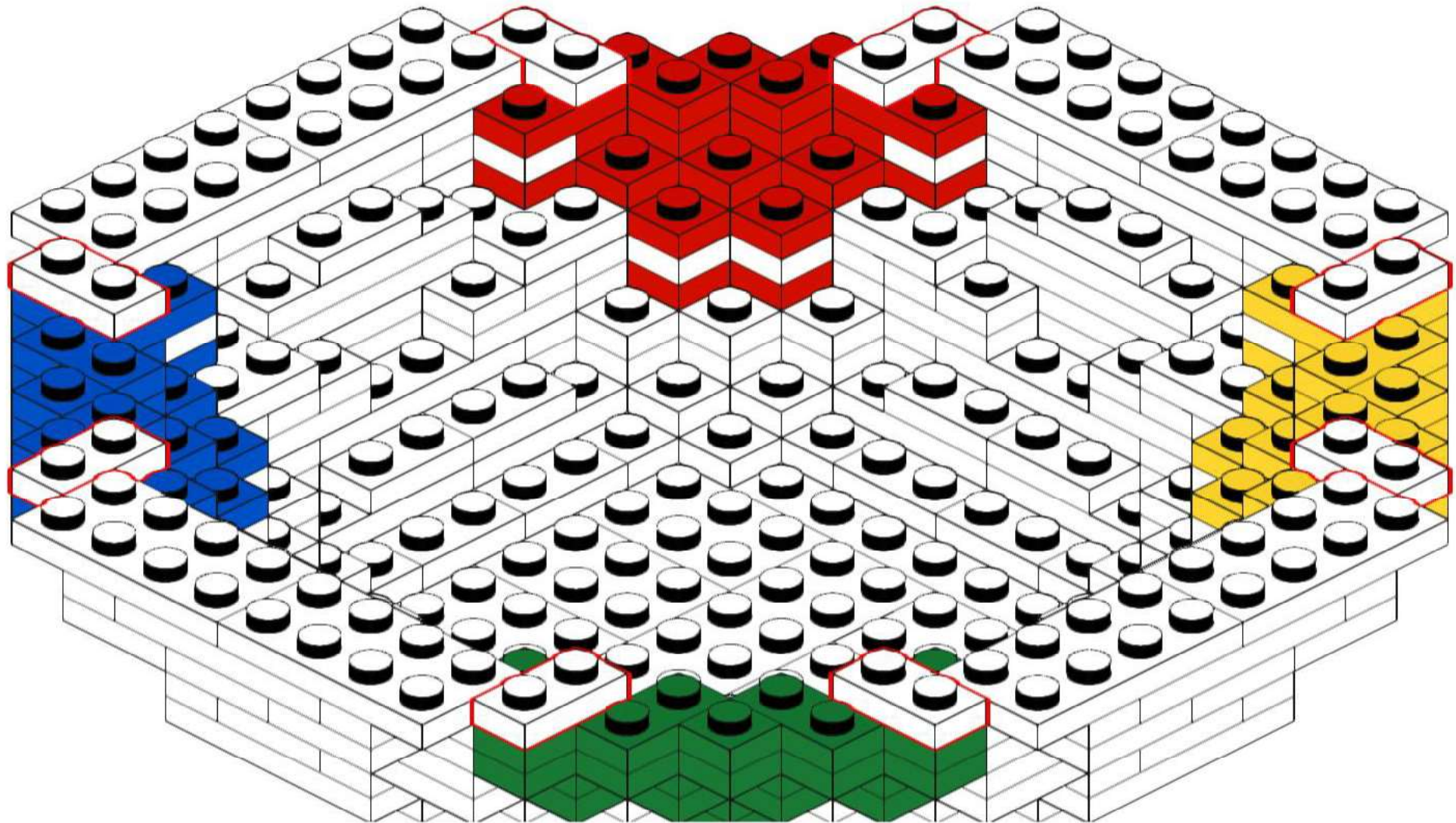
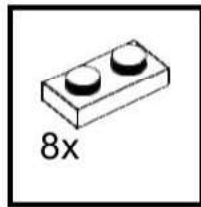

45

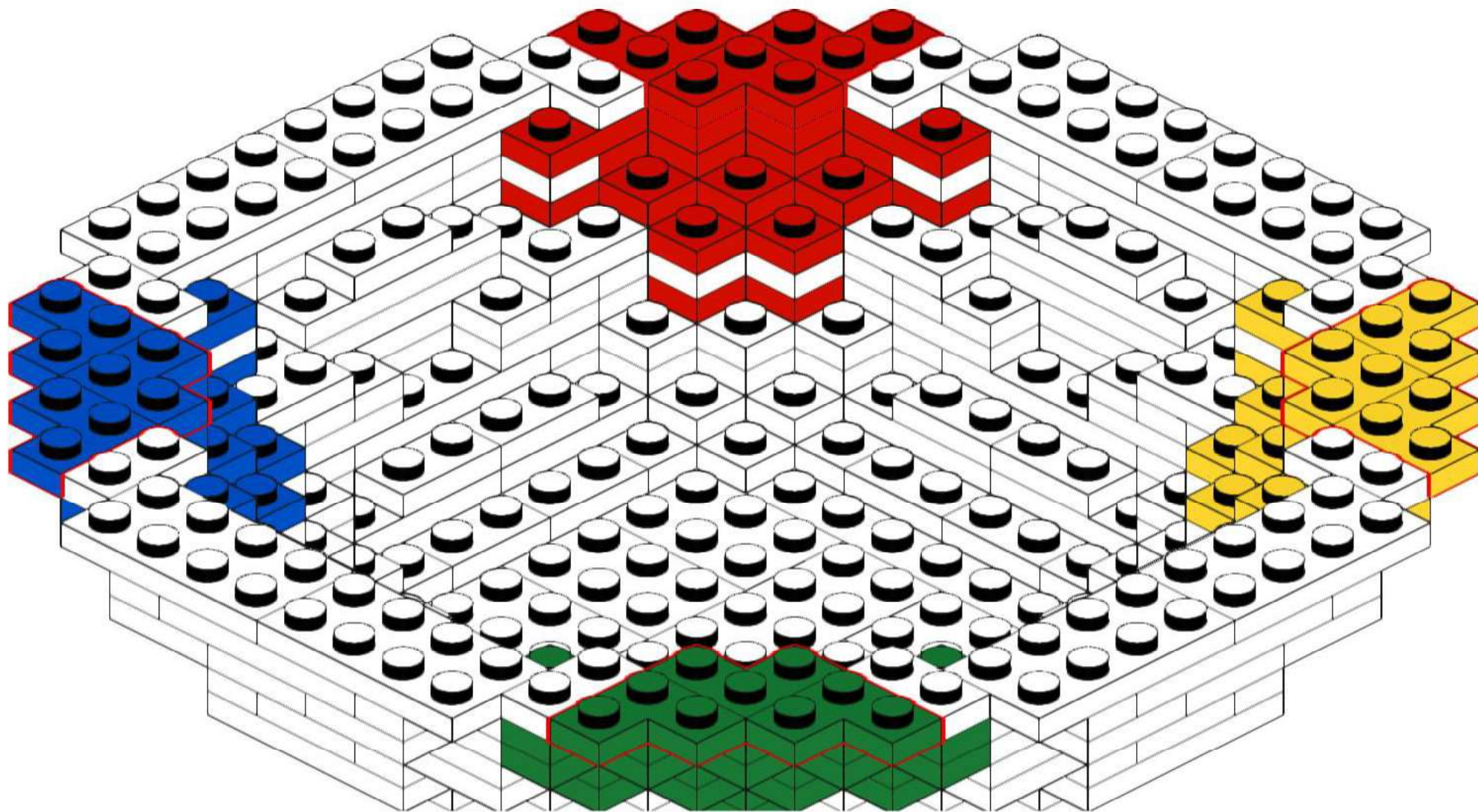
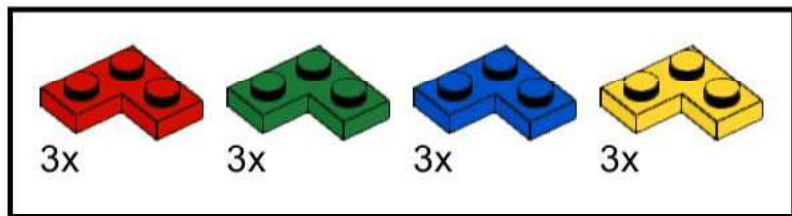

46

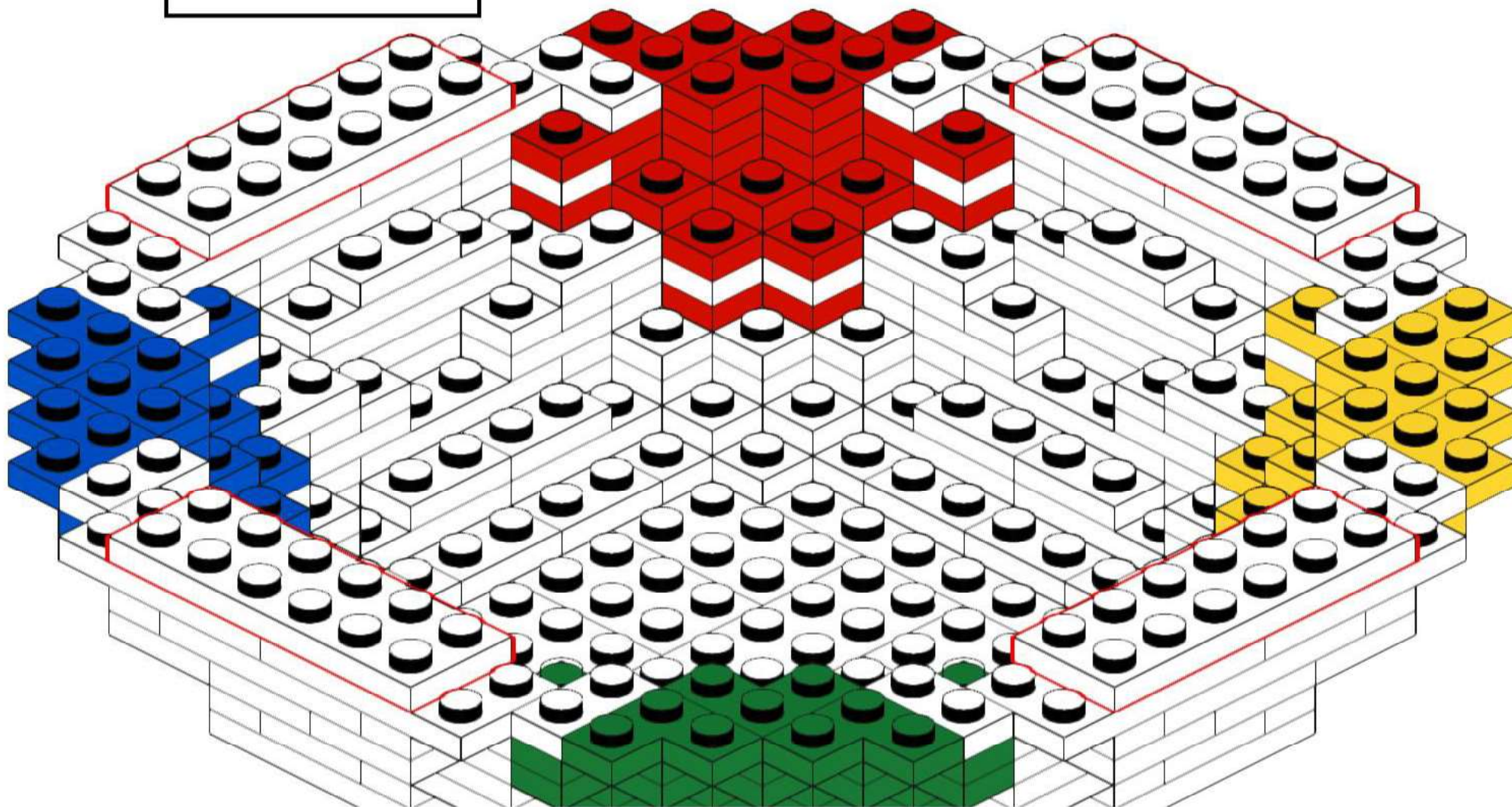
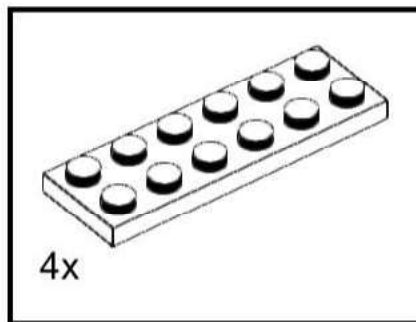

47

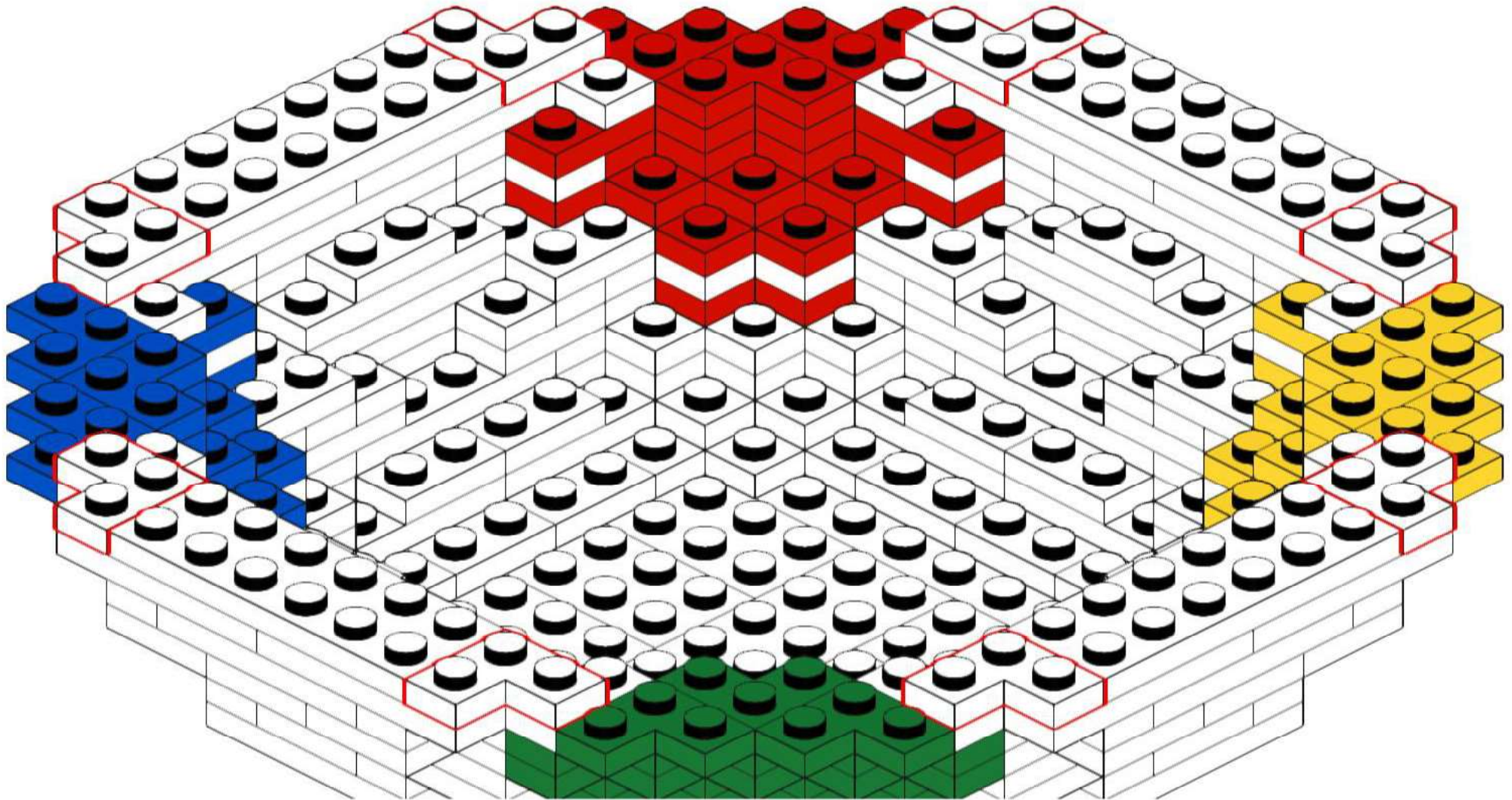
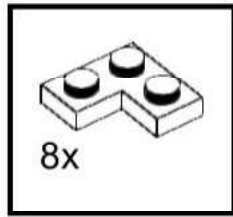

48

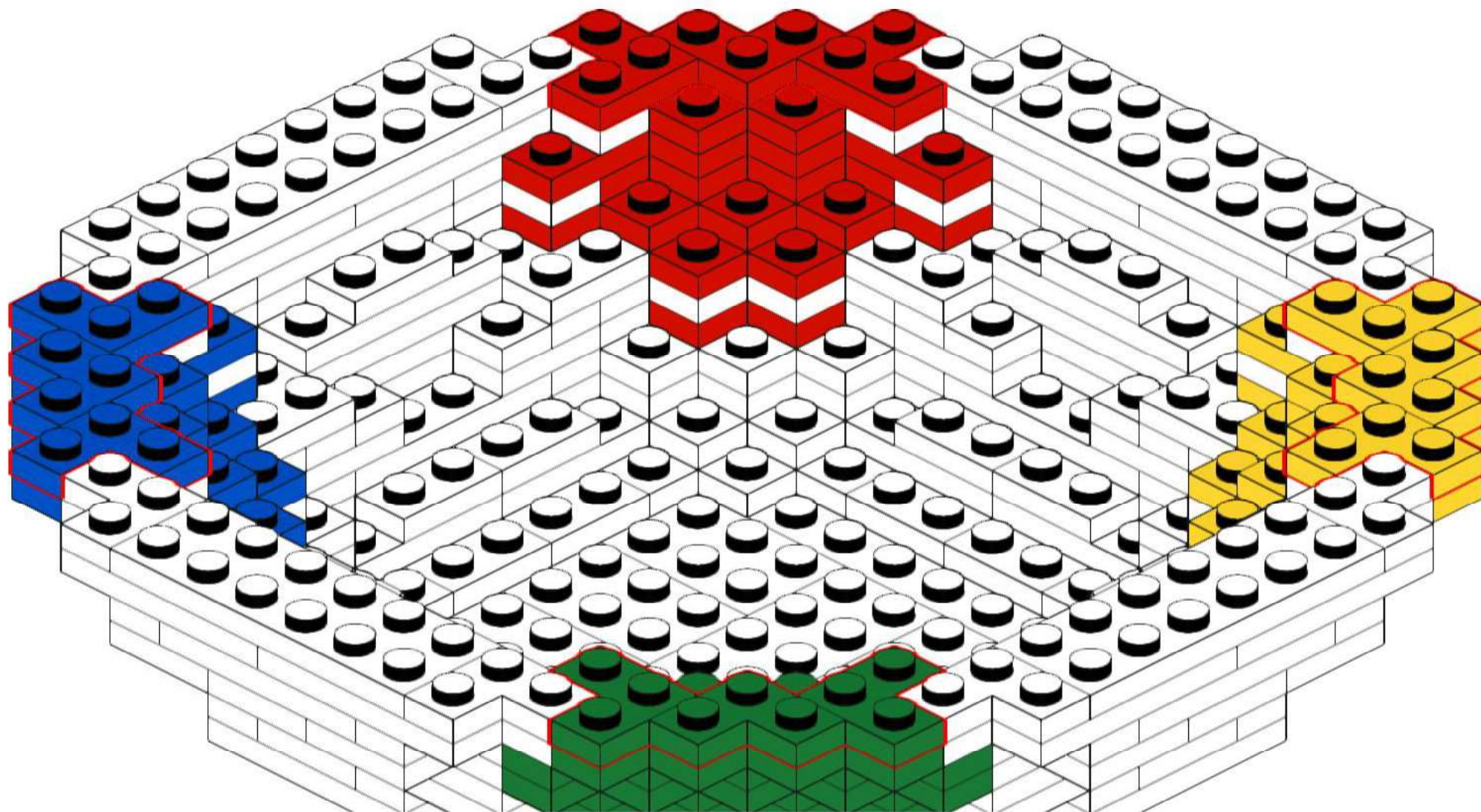
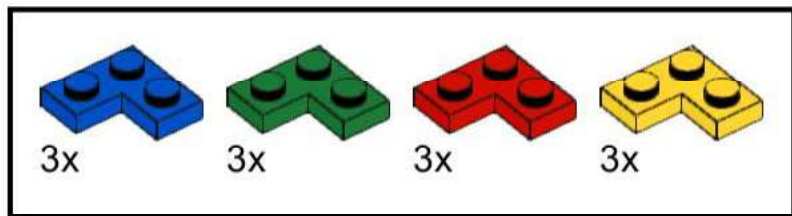

49

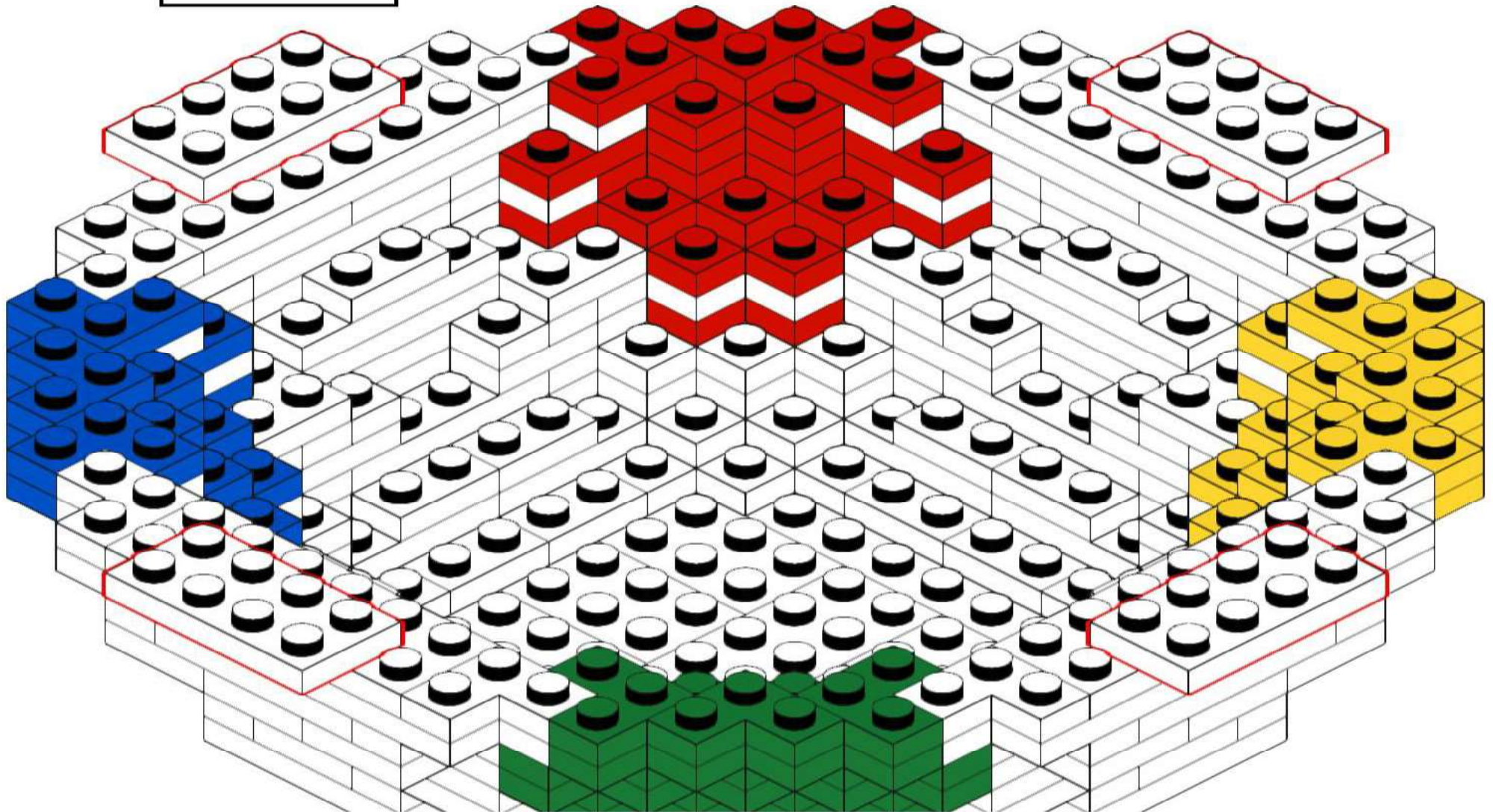
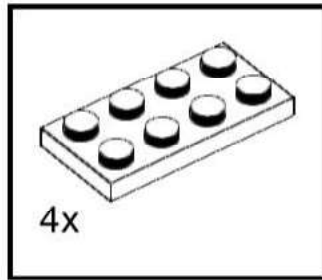

50

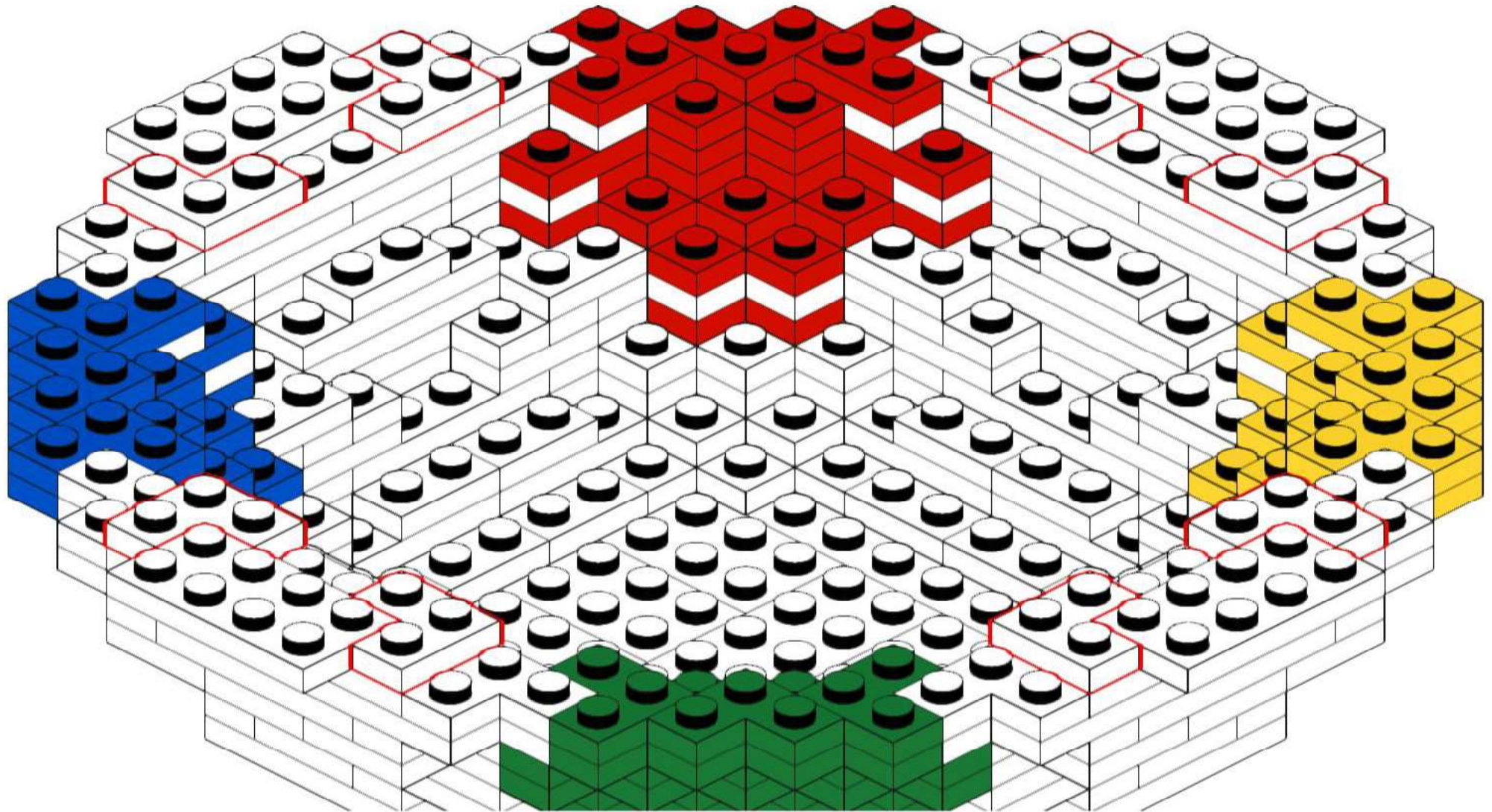
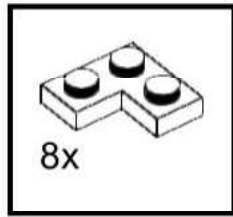

51

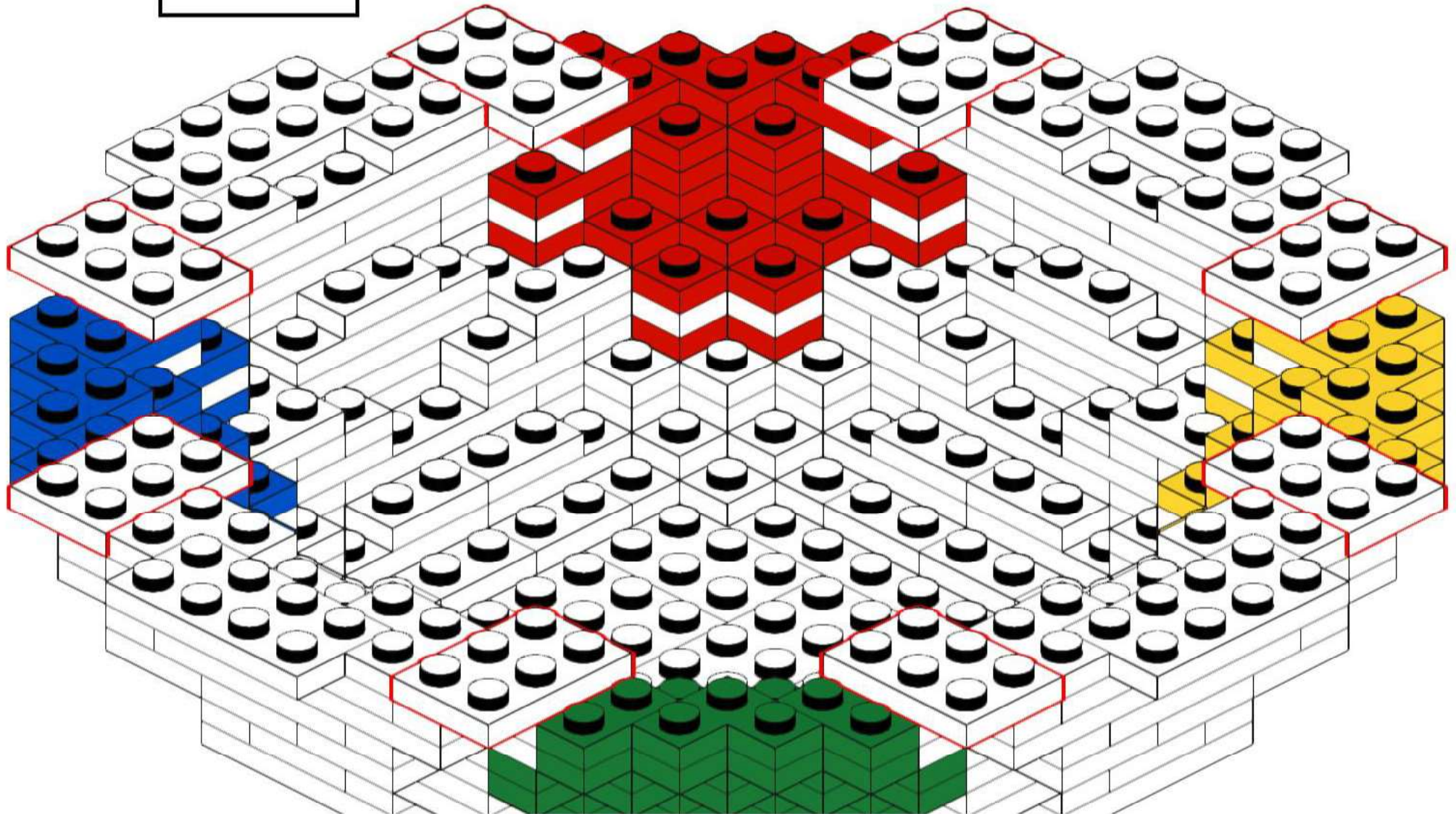
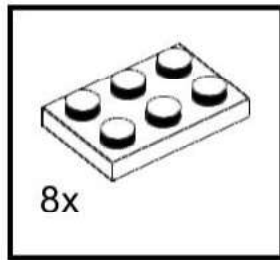

52

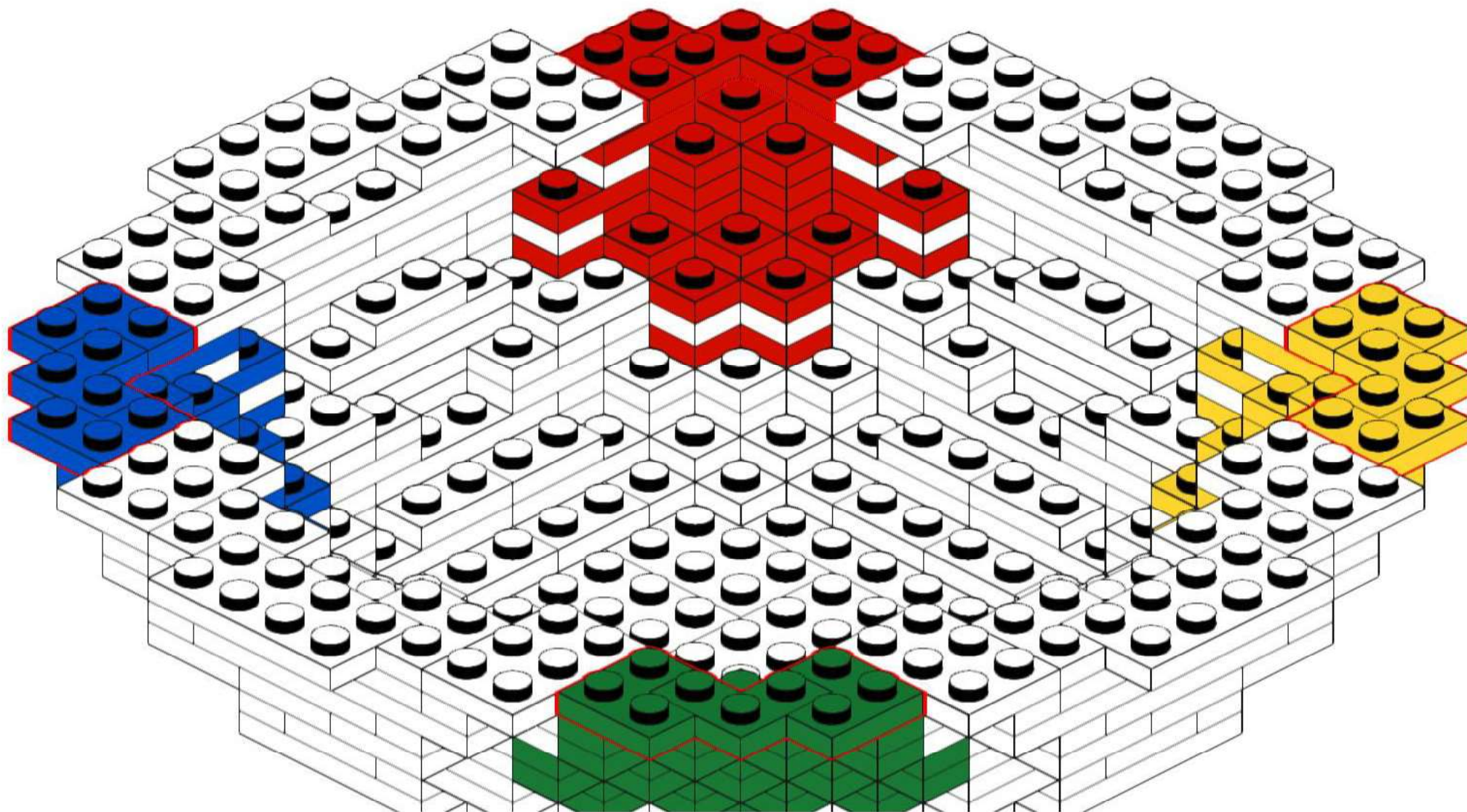
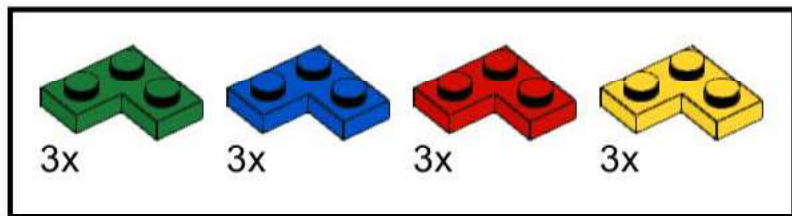

53

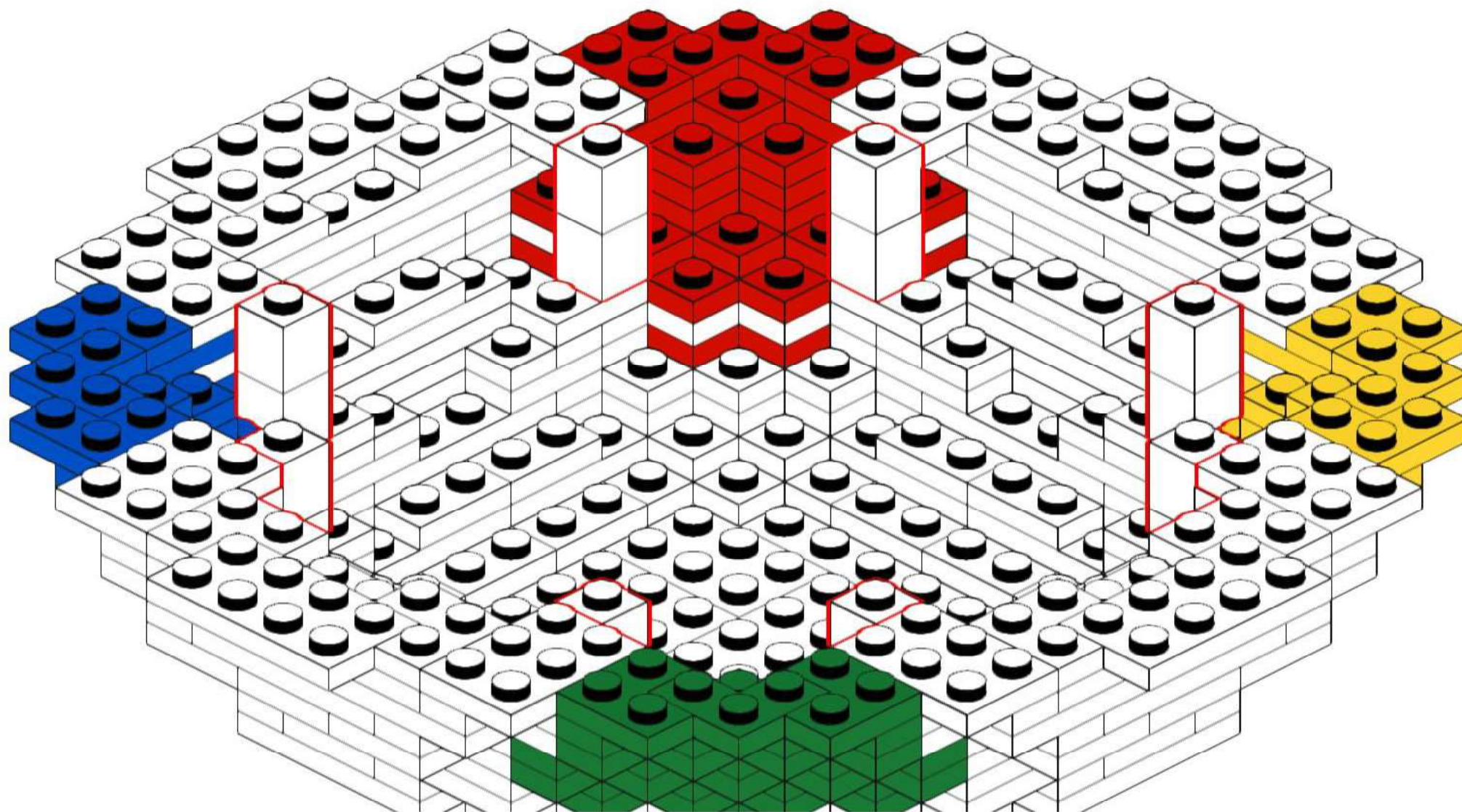
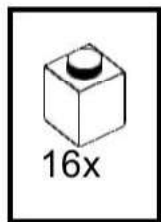

54

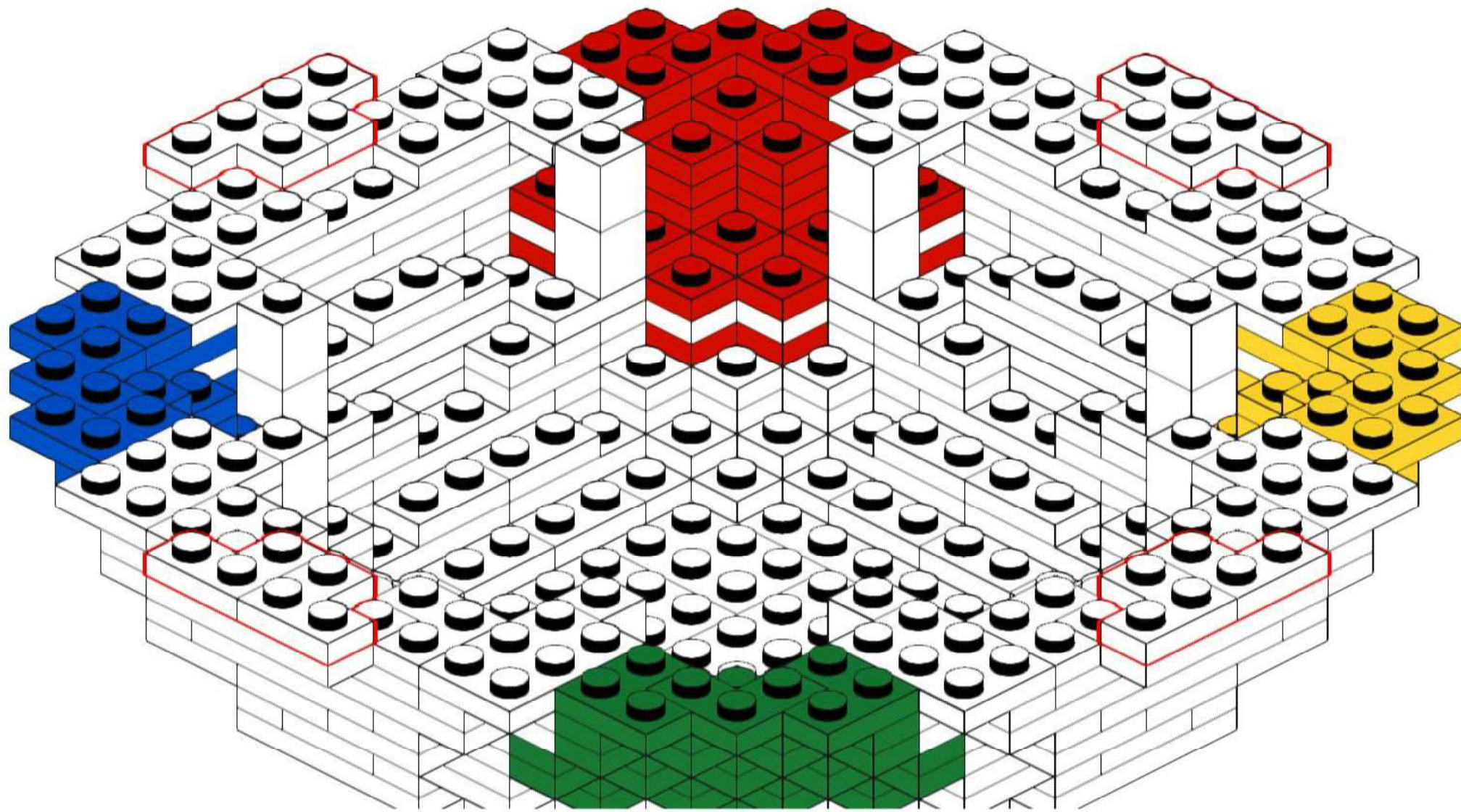
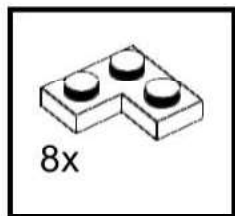

55

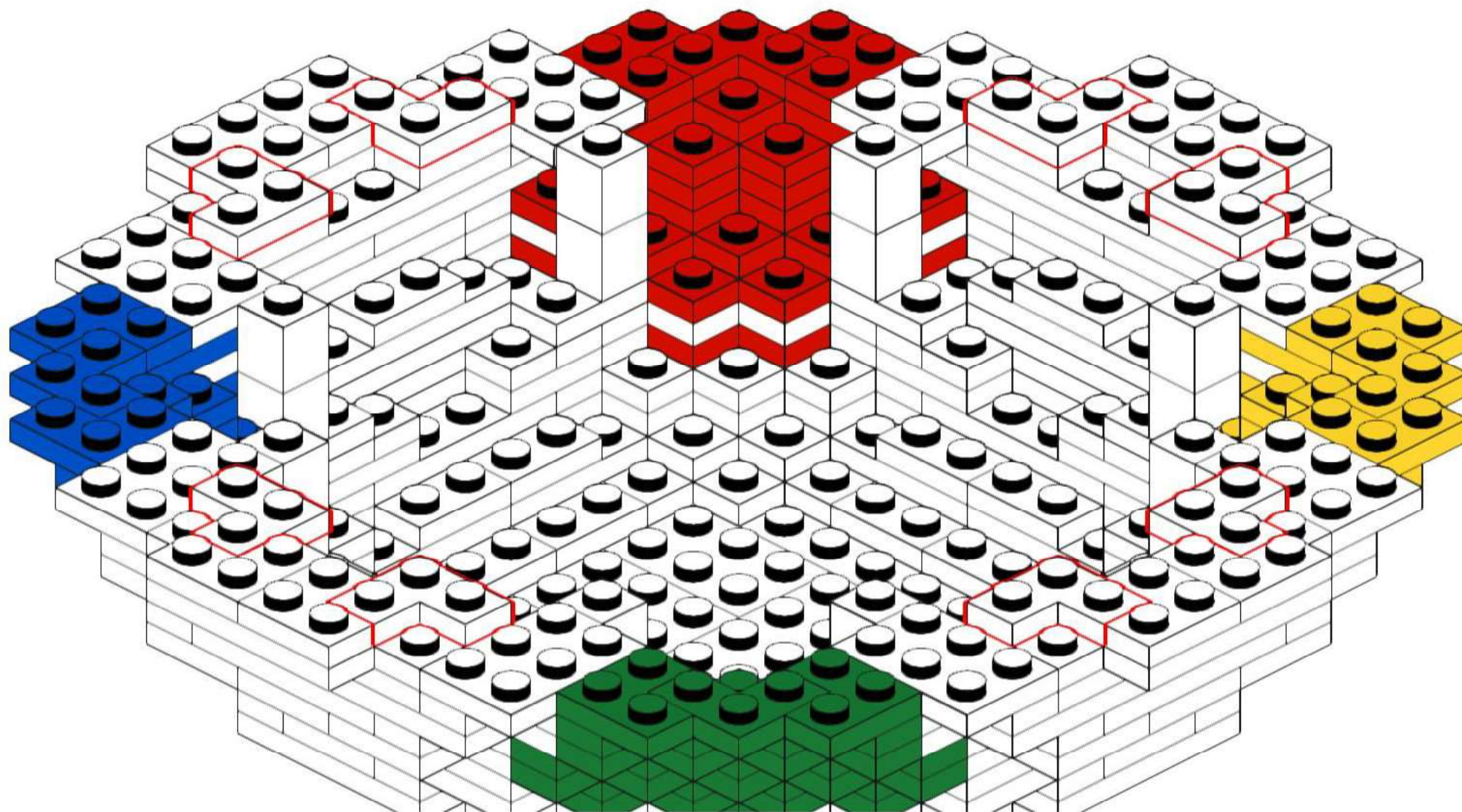
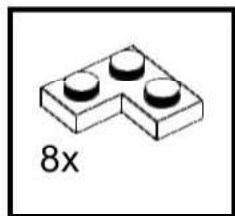

56

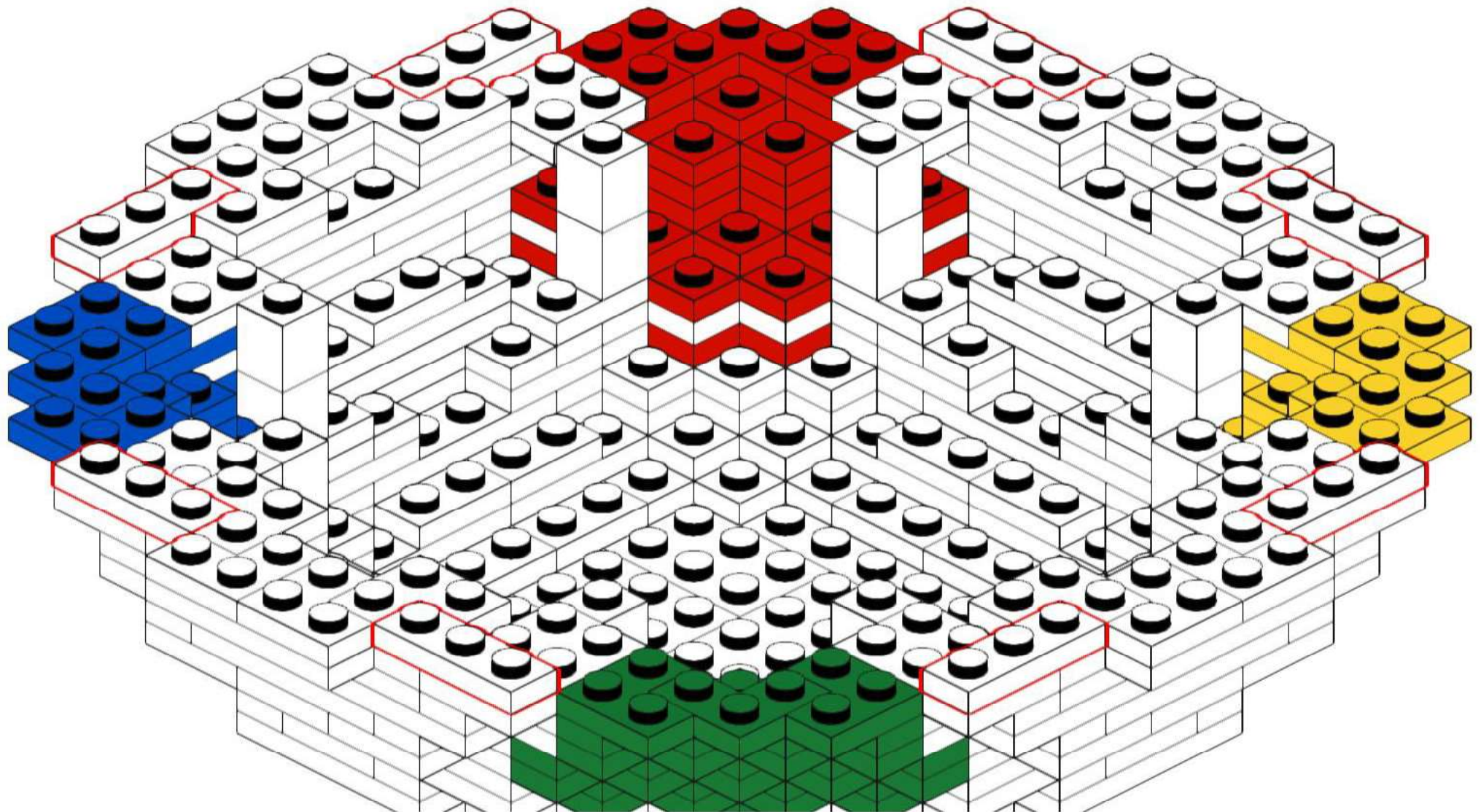
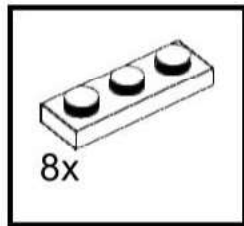

57

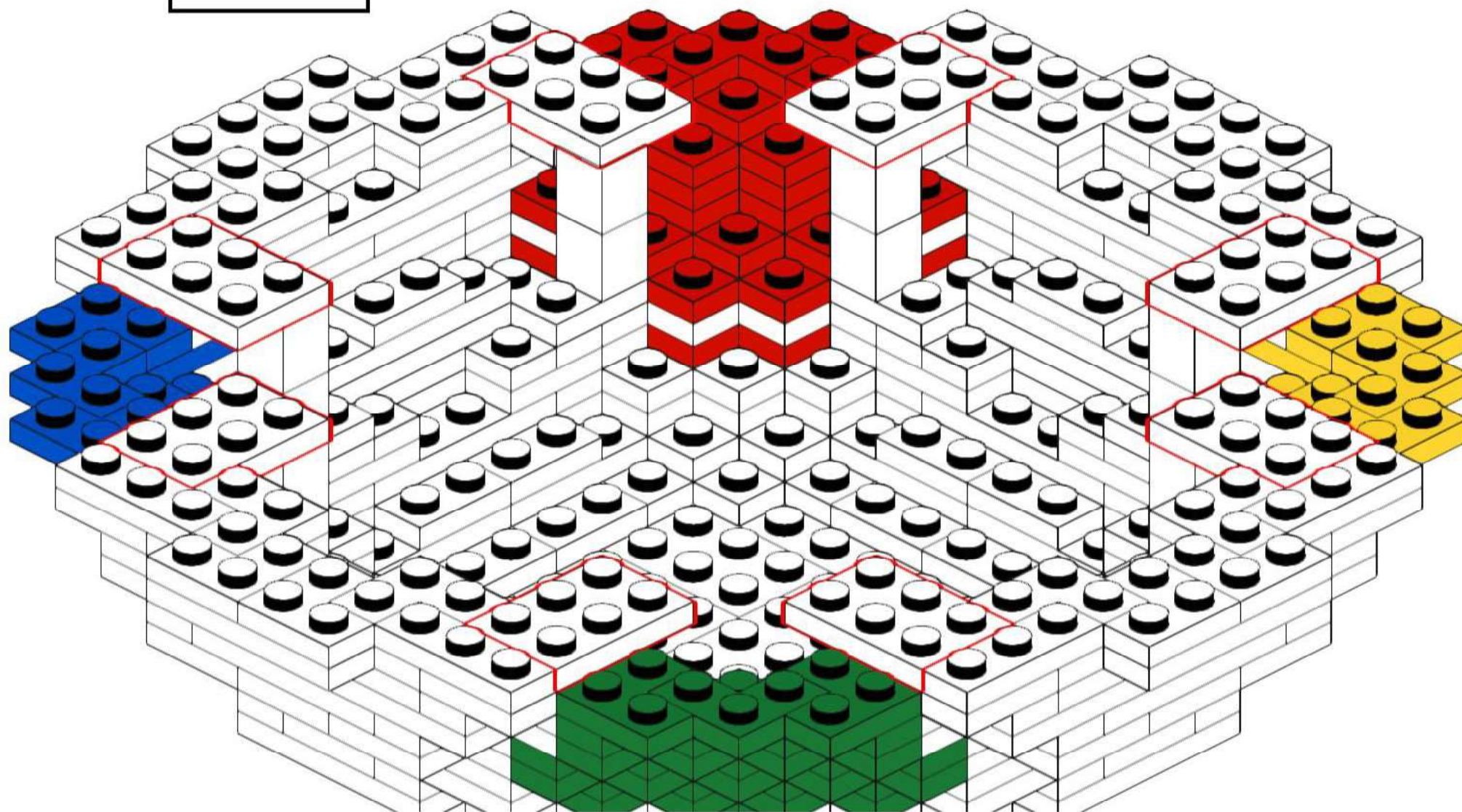
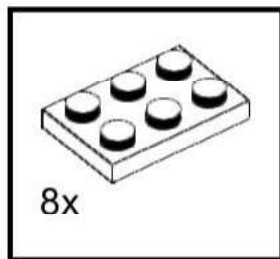

58

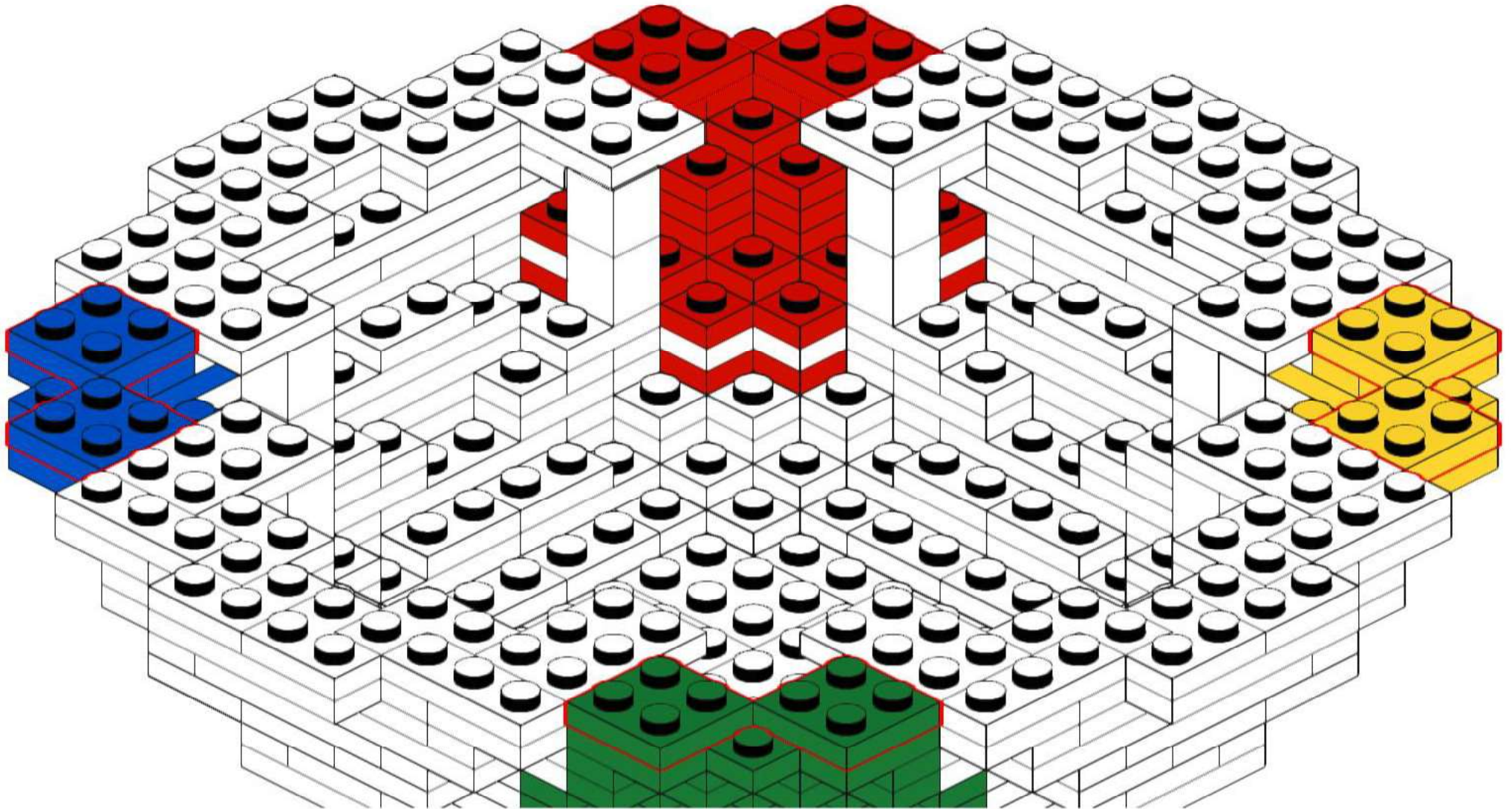
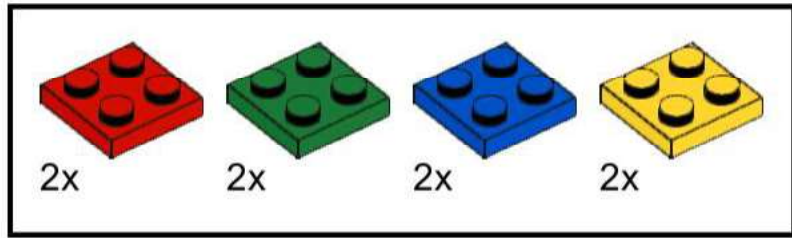

59

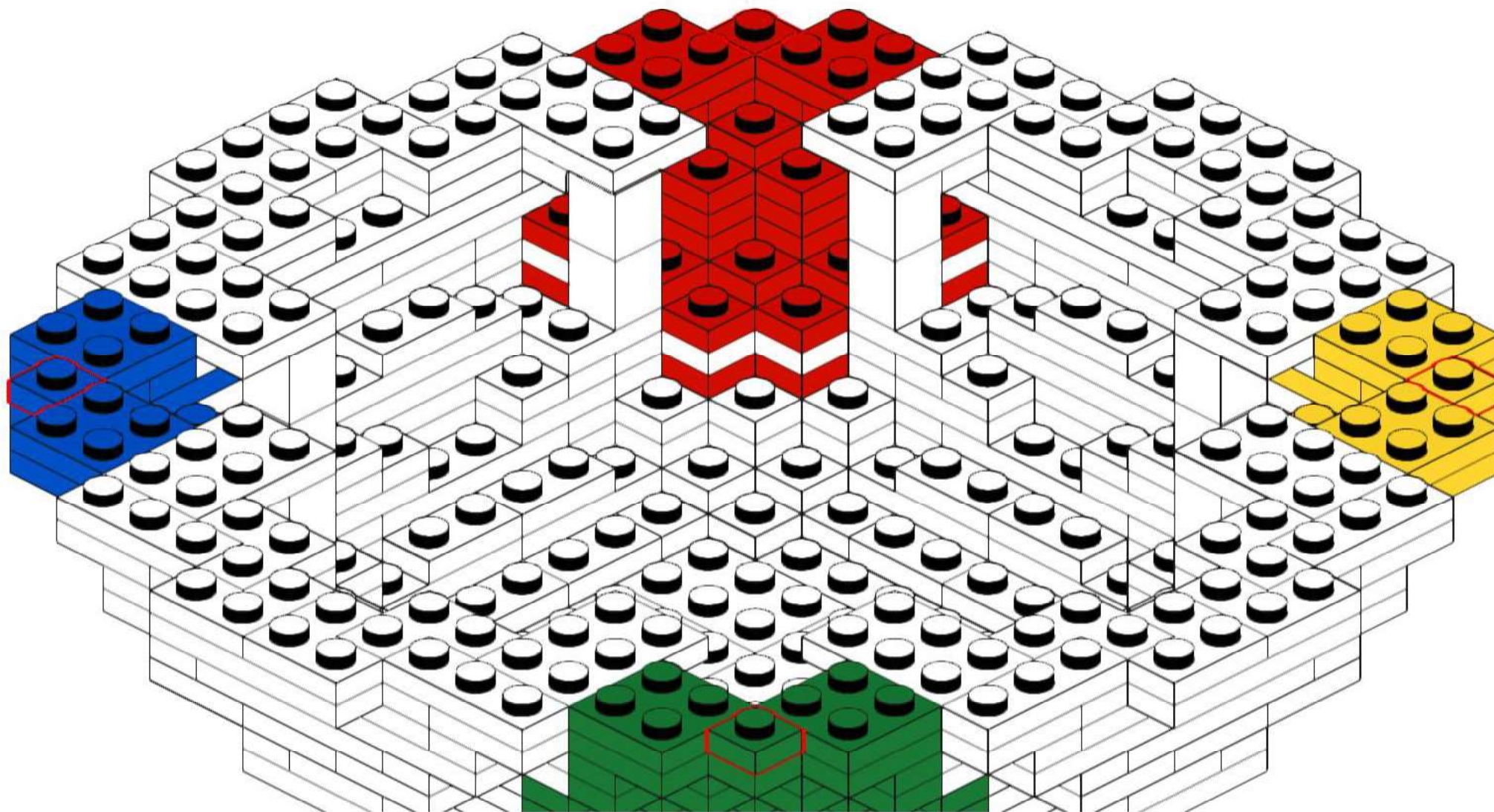
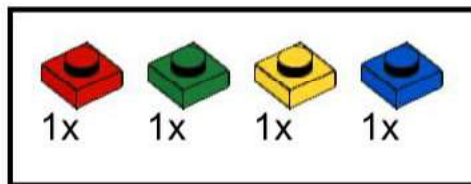

60

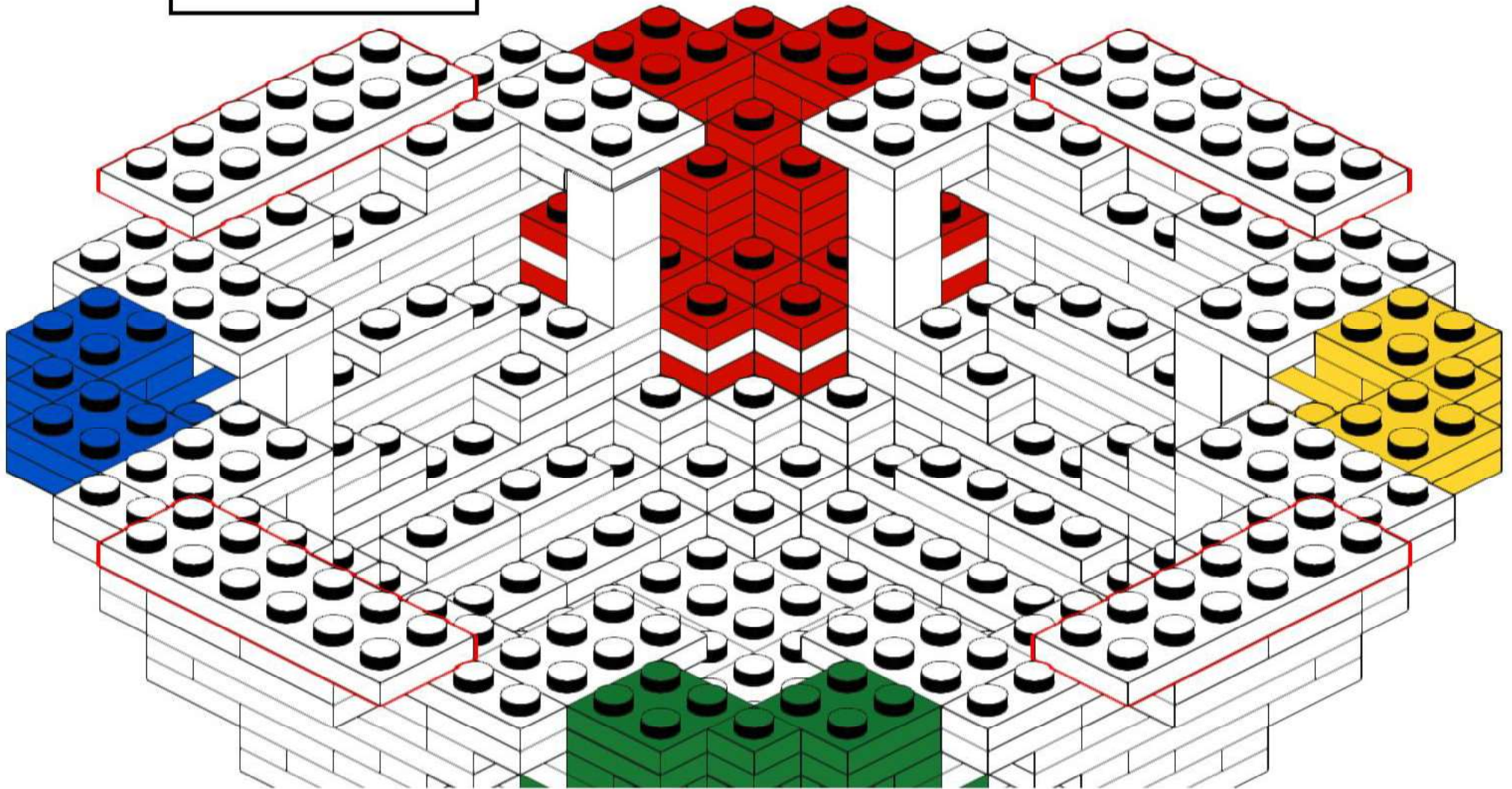
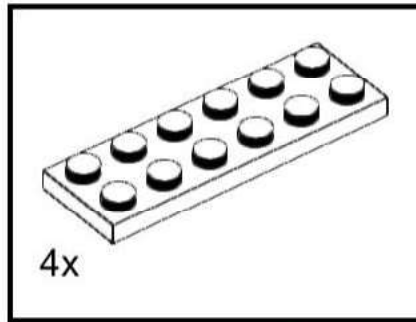

61

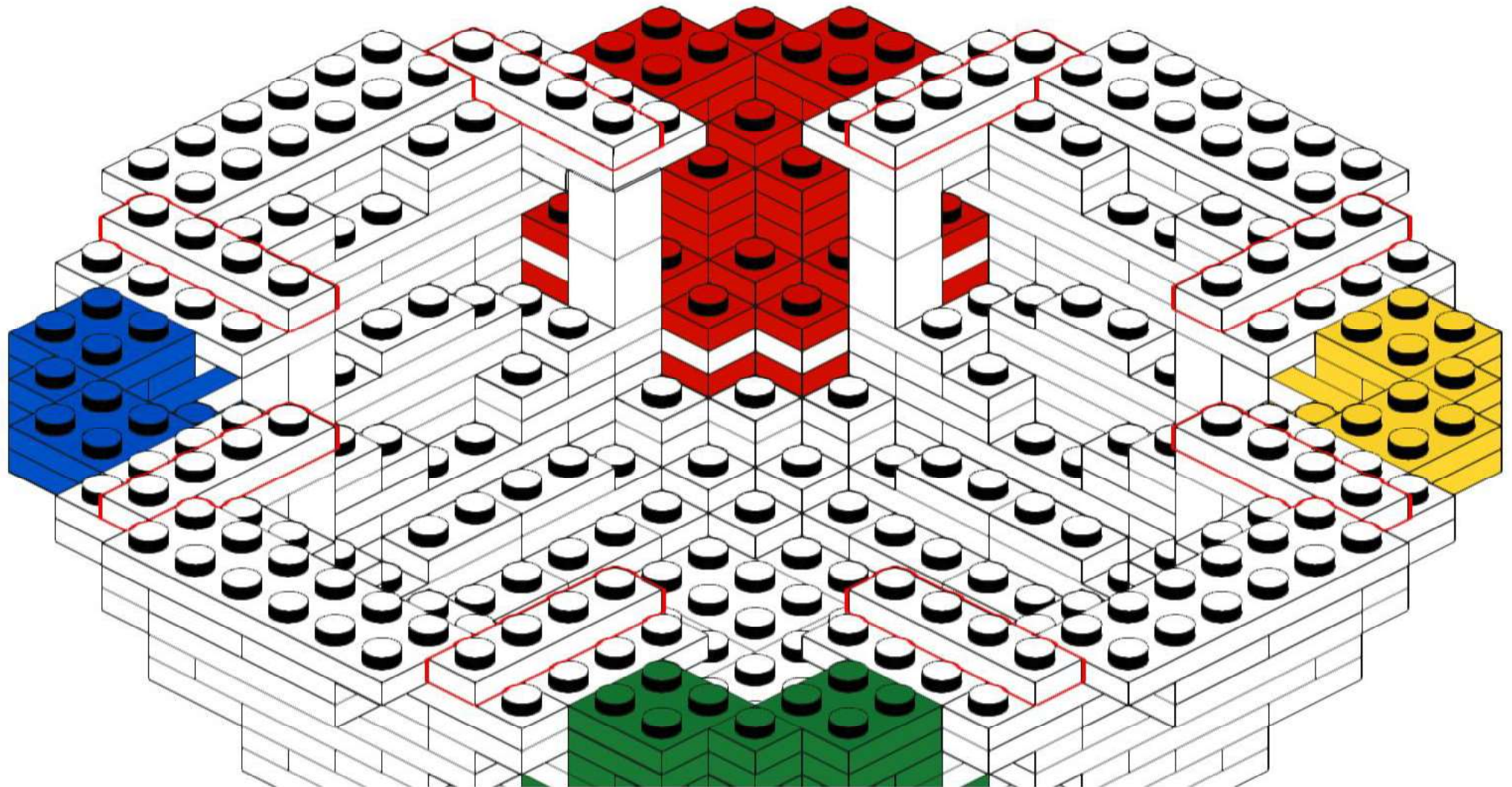
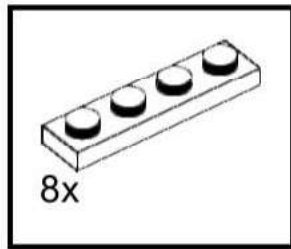

62

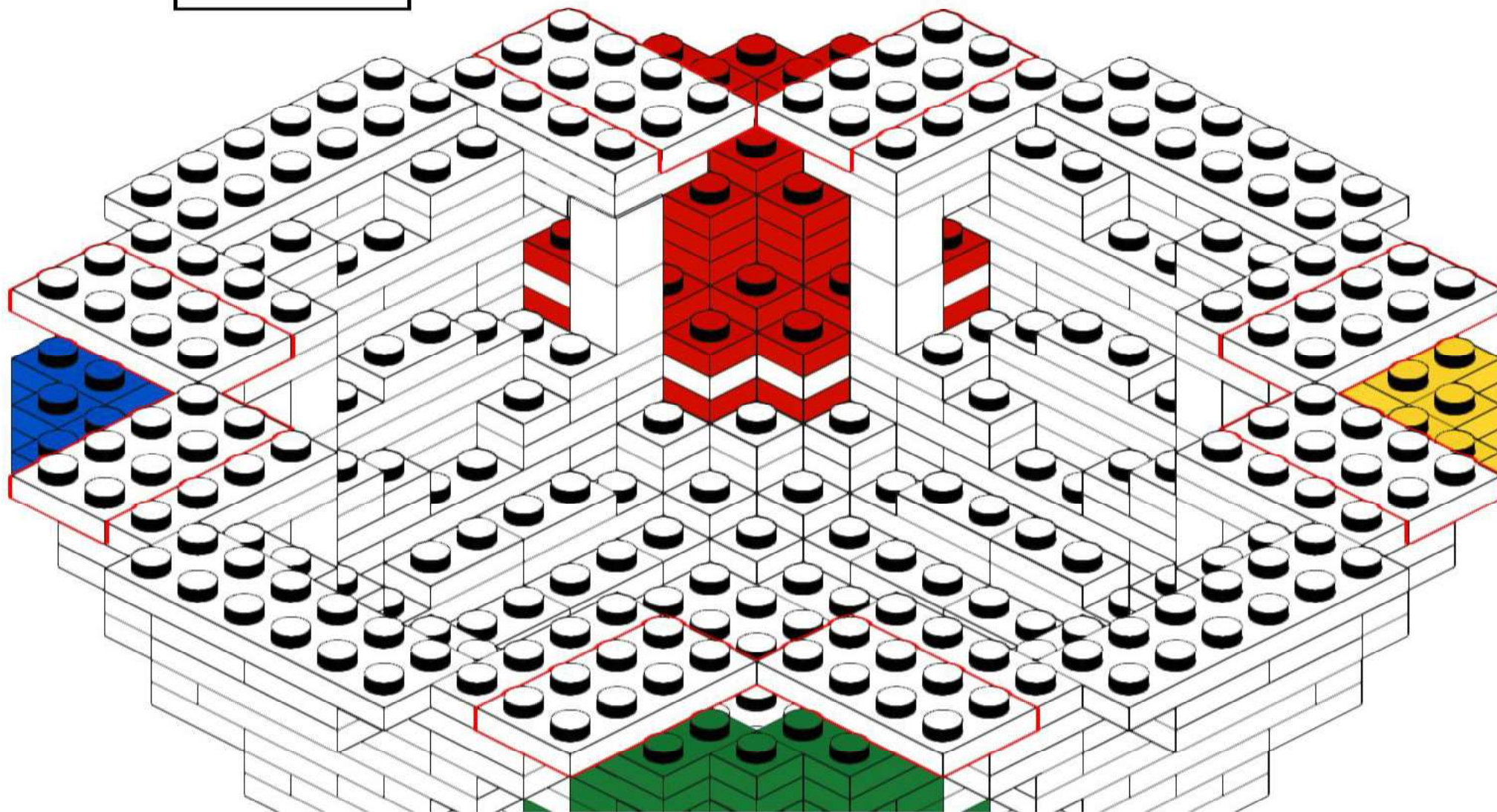
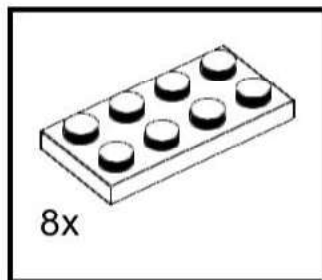

63

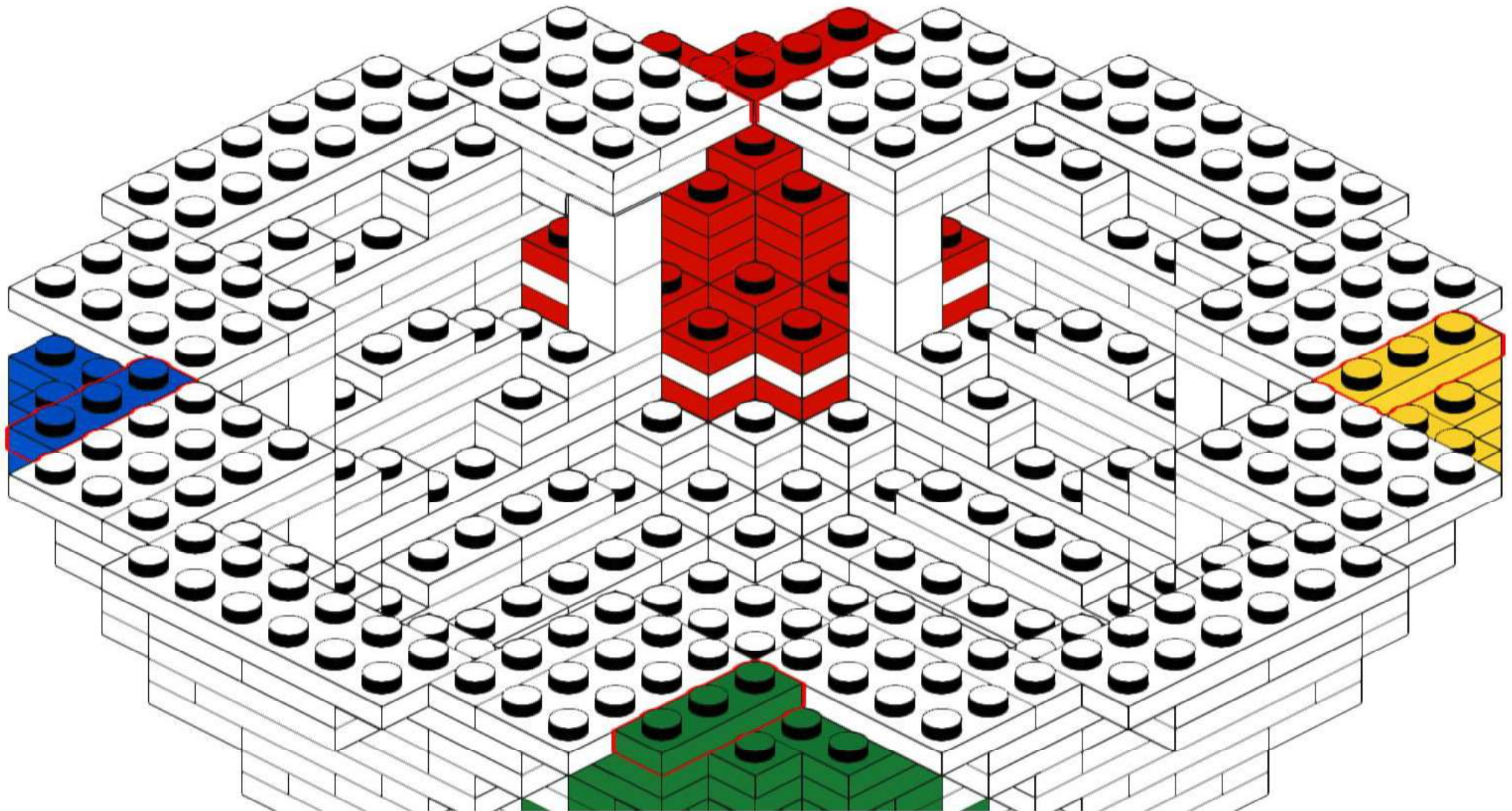
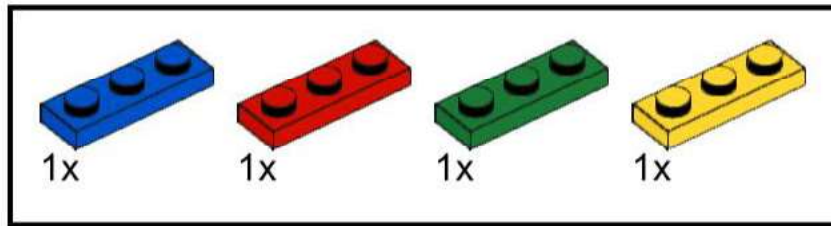

64

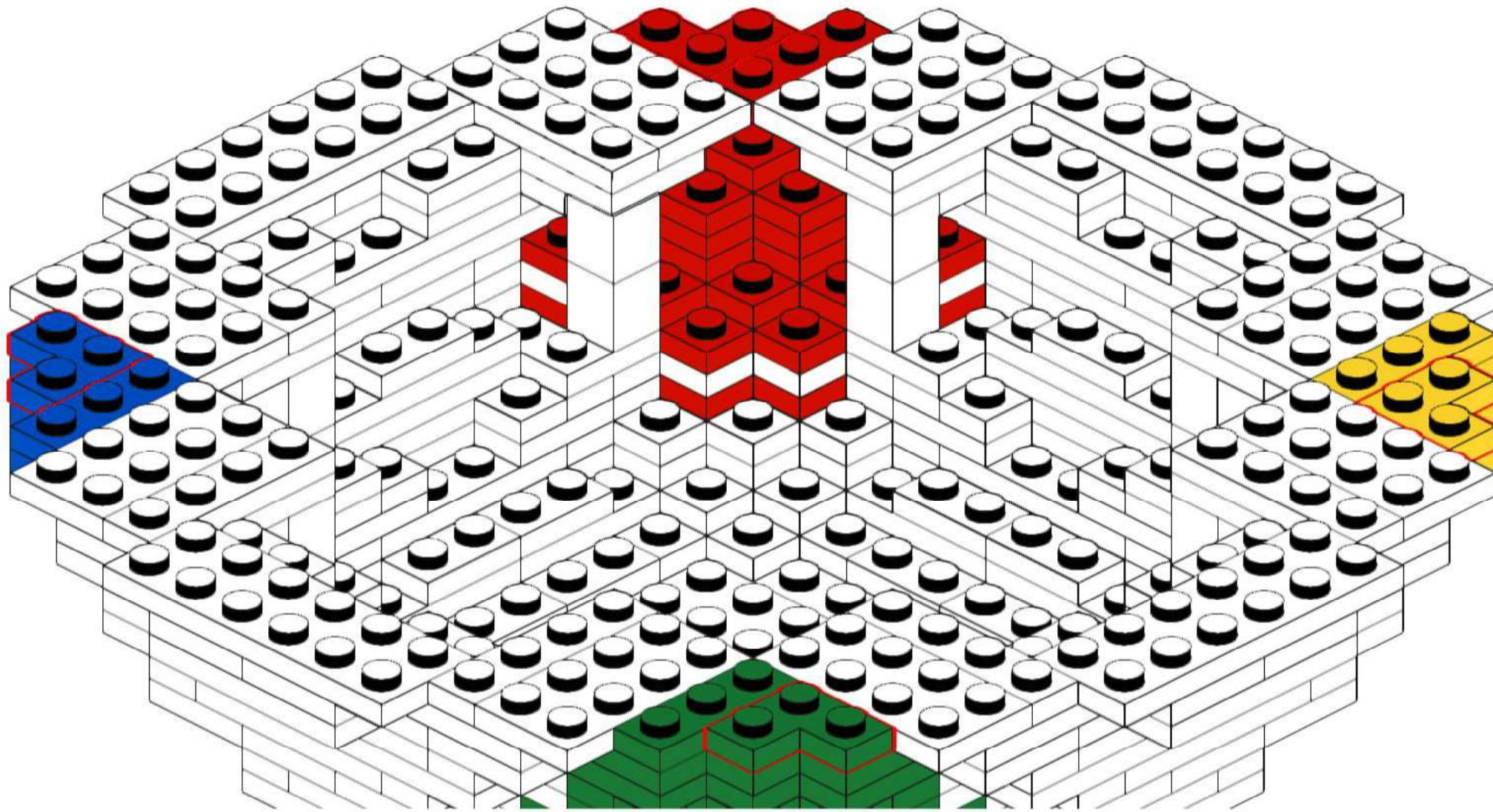
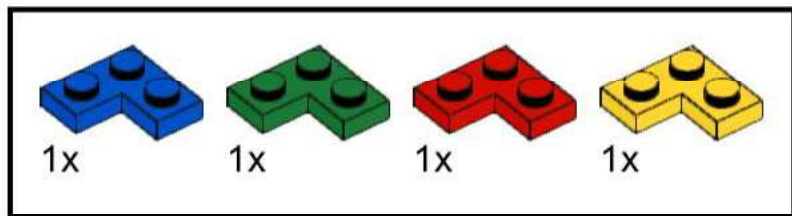

65

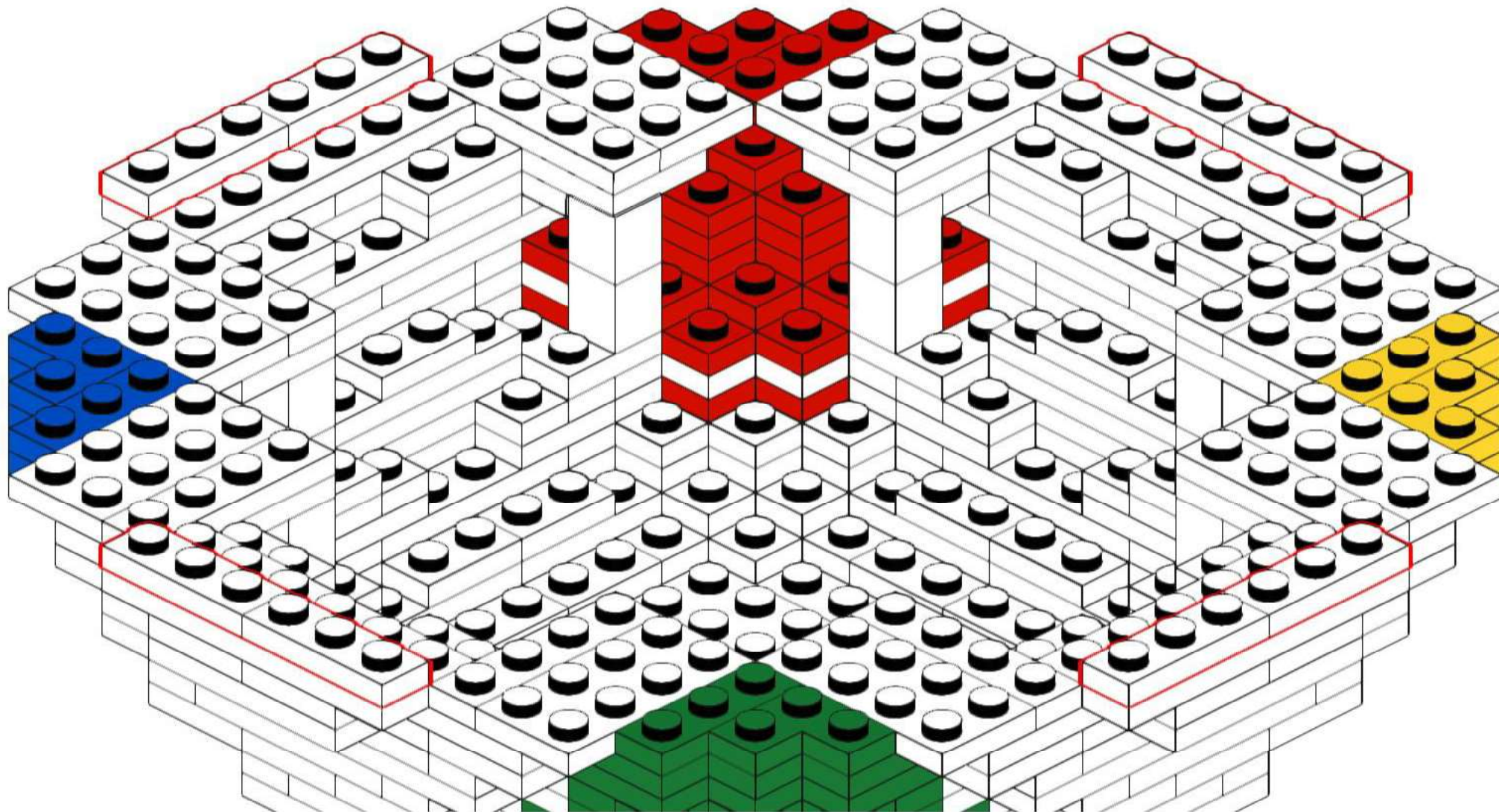
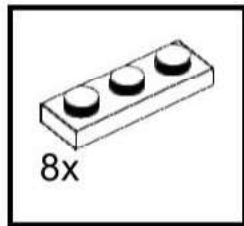

66

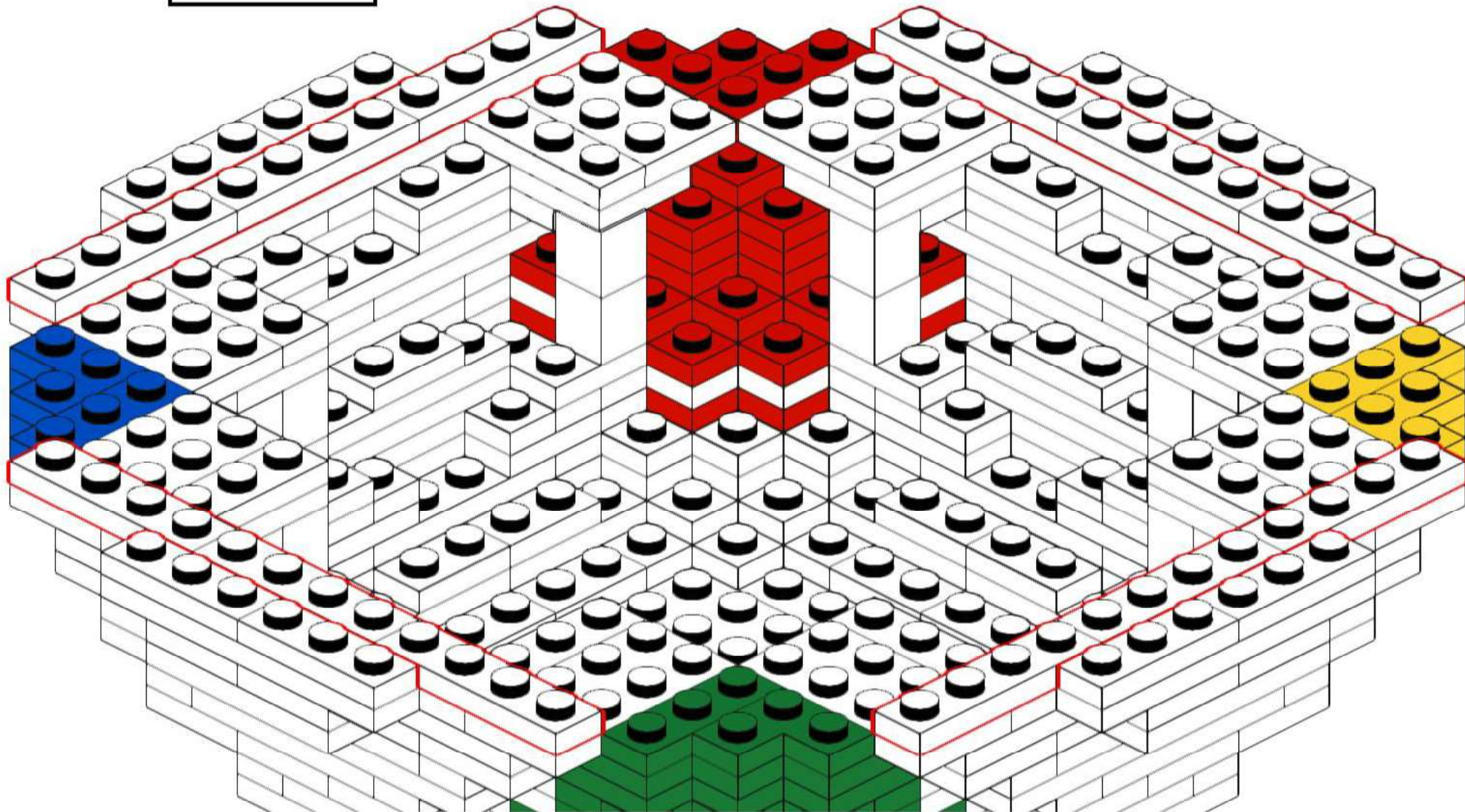
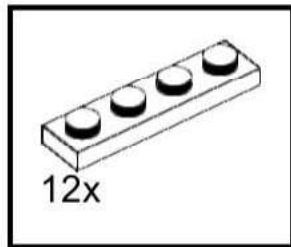

67

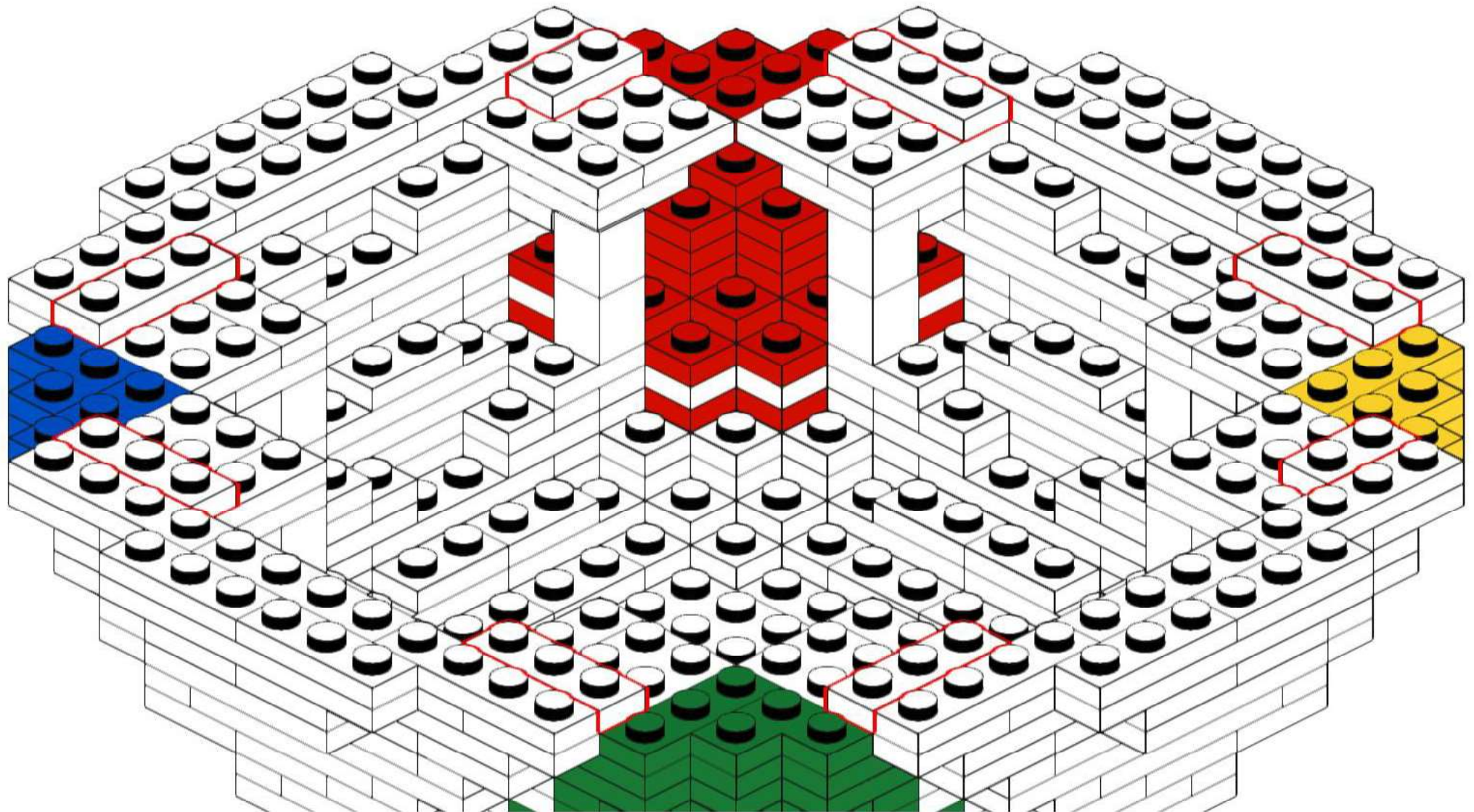
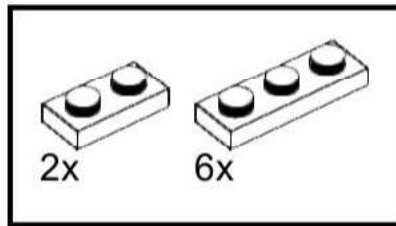

68

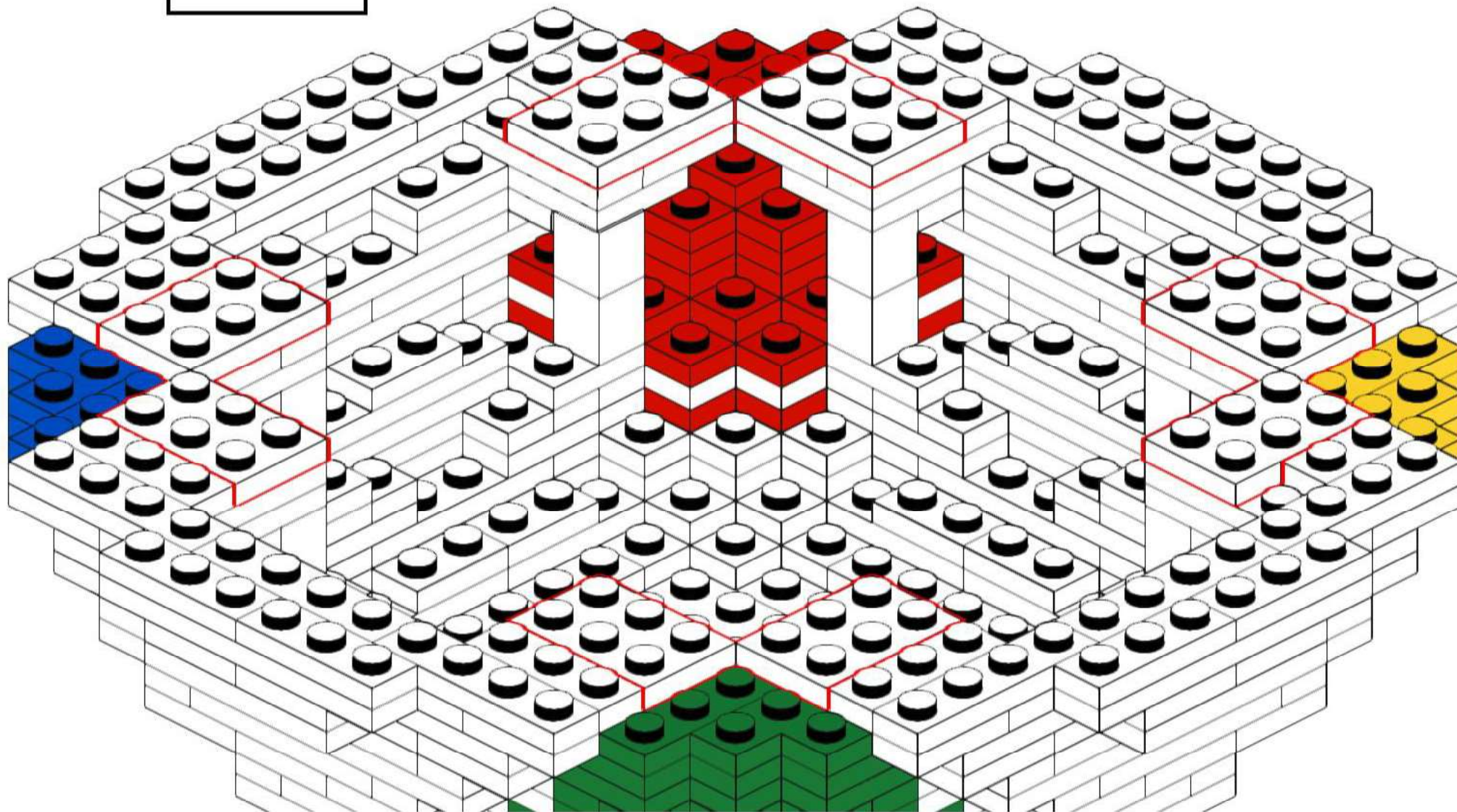
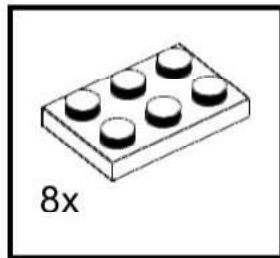

69

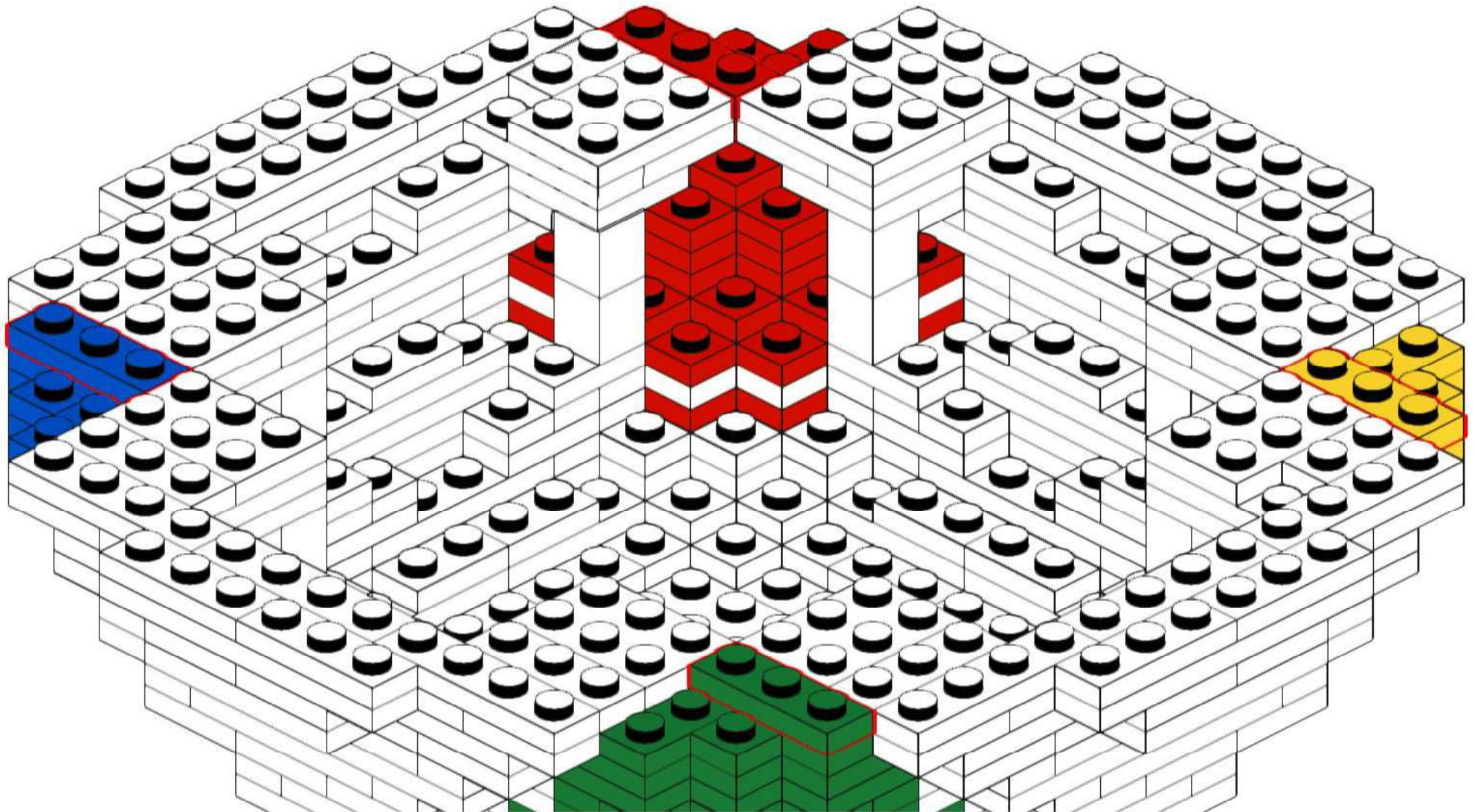
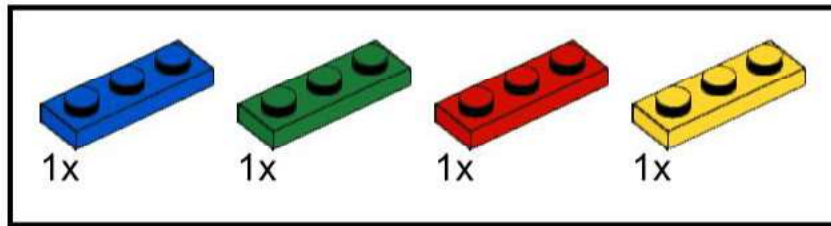

70

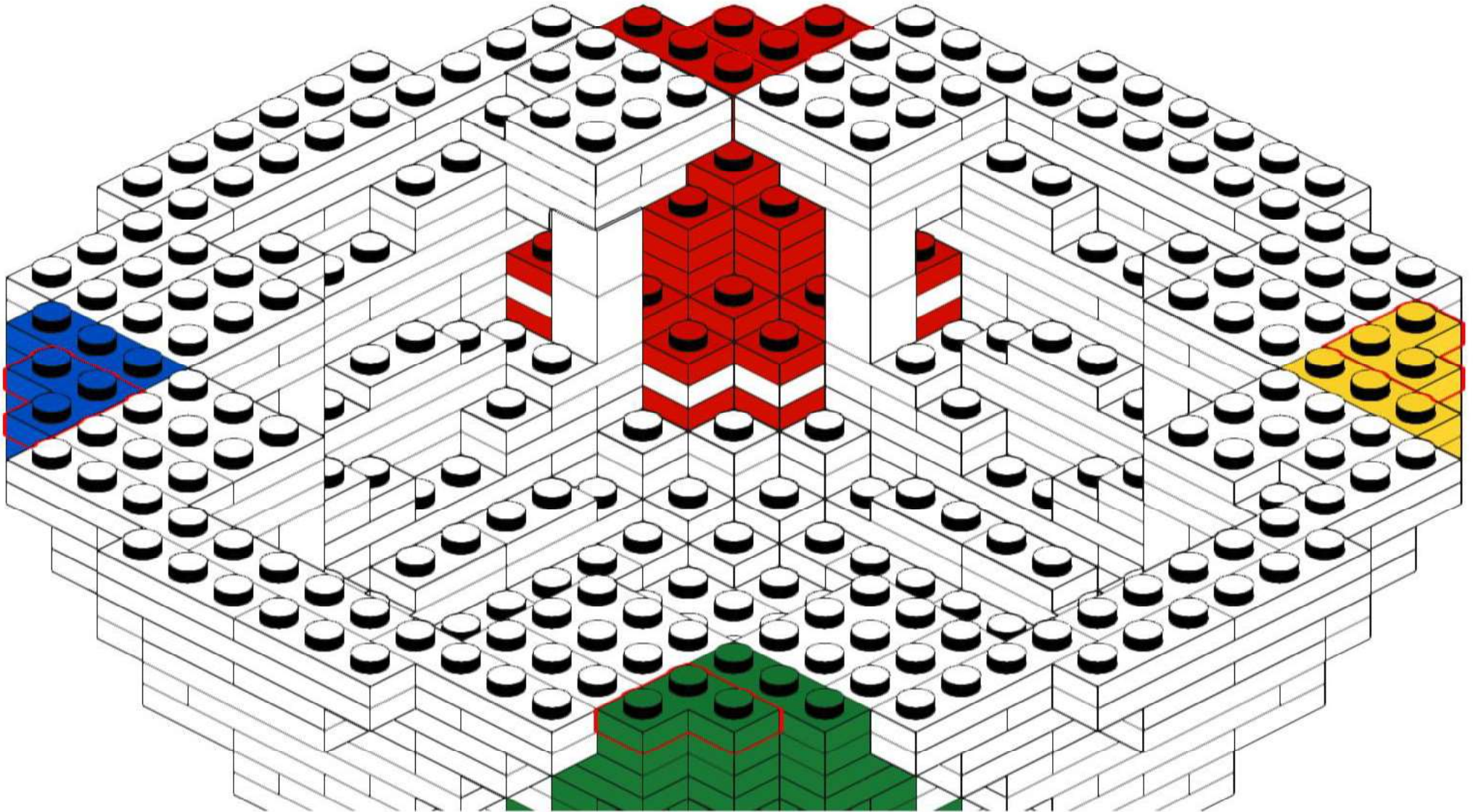
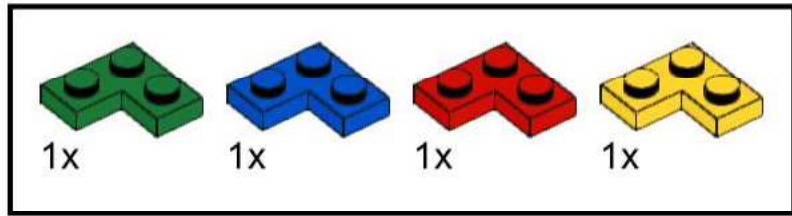

71
NF

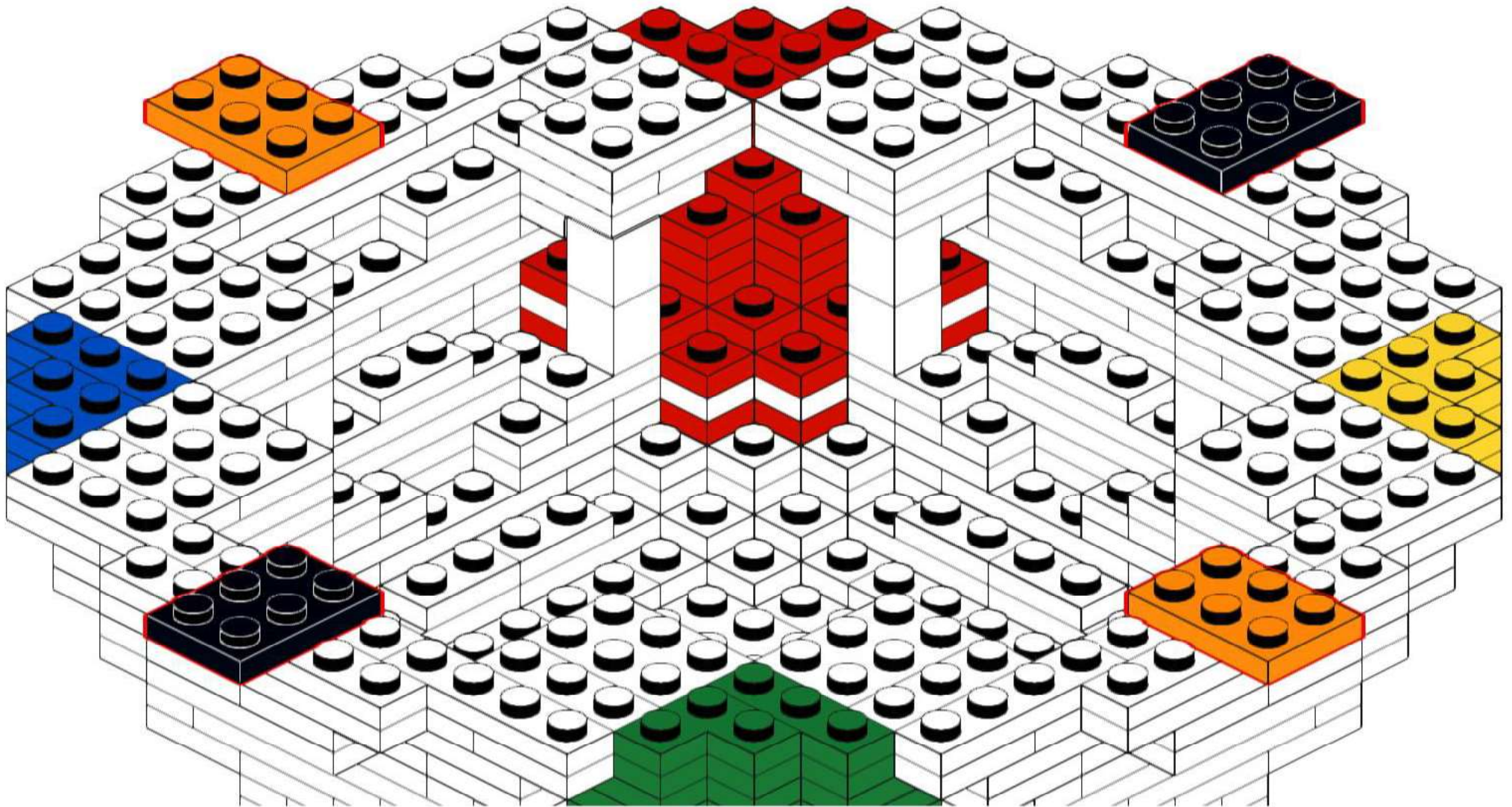
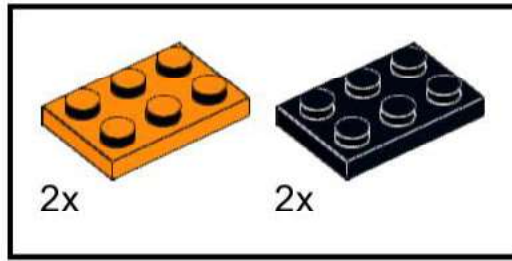

72

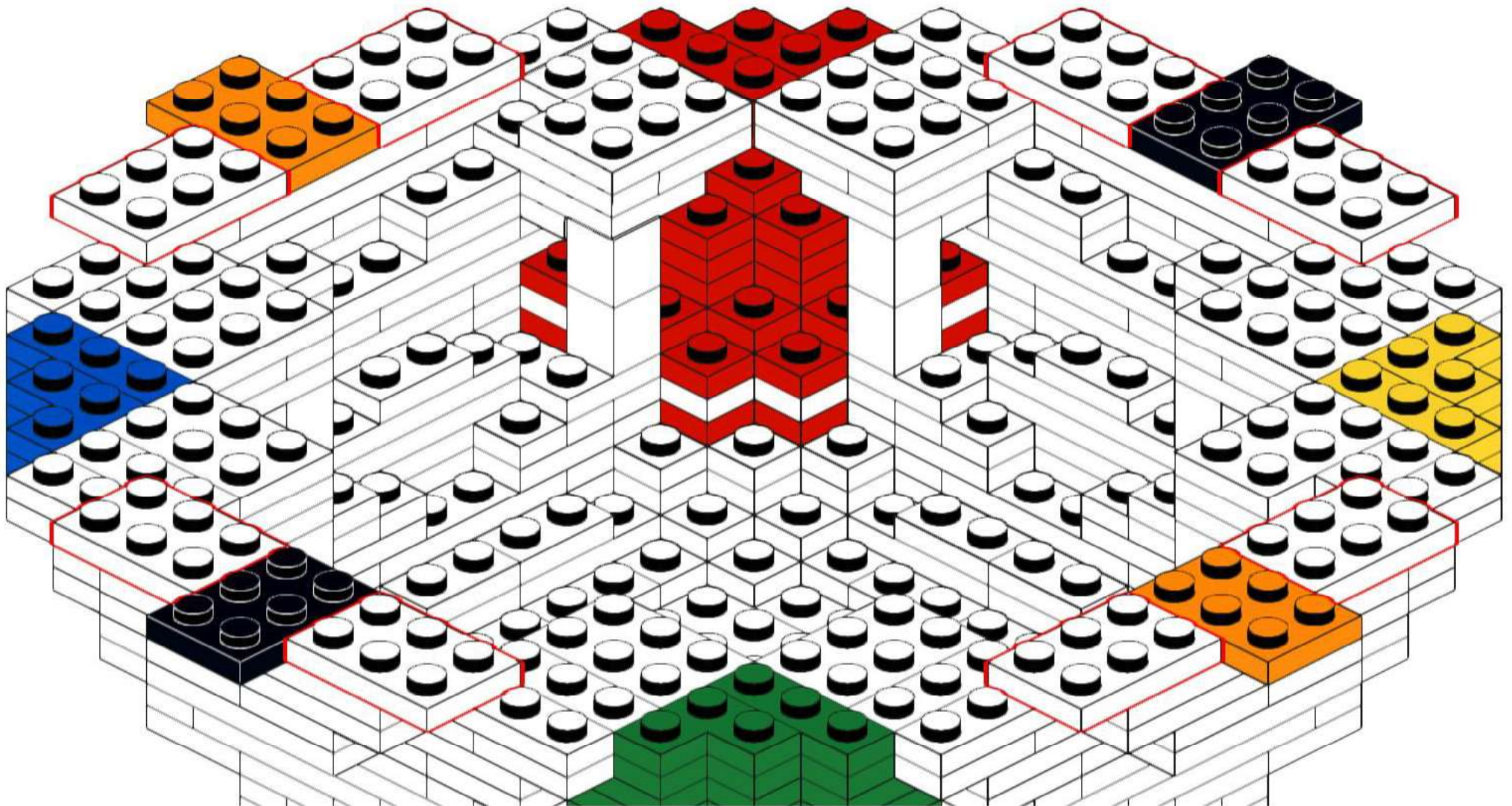
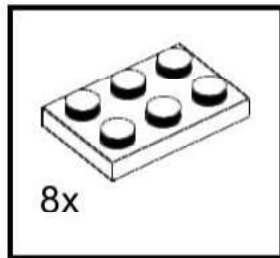

73

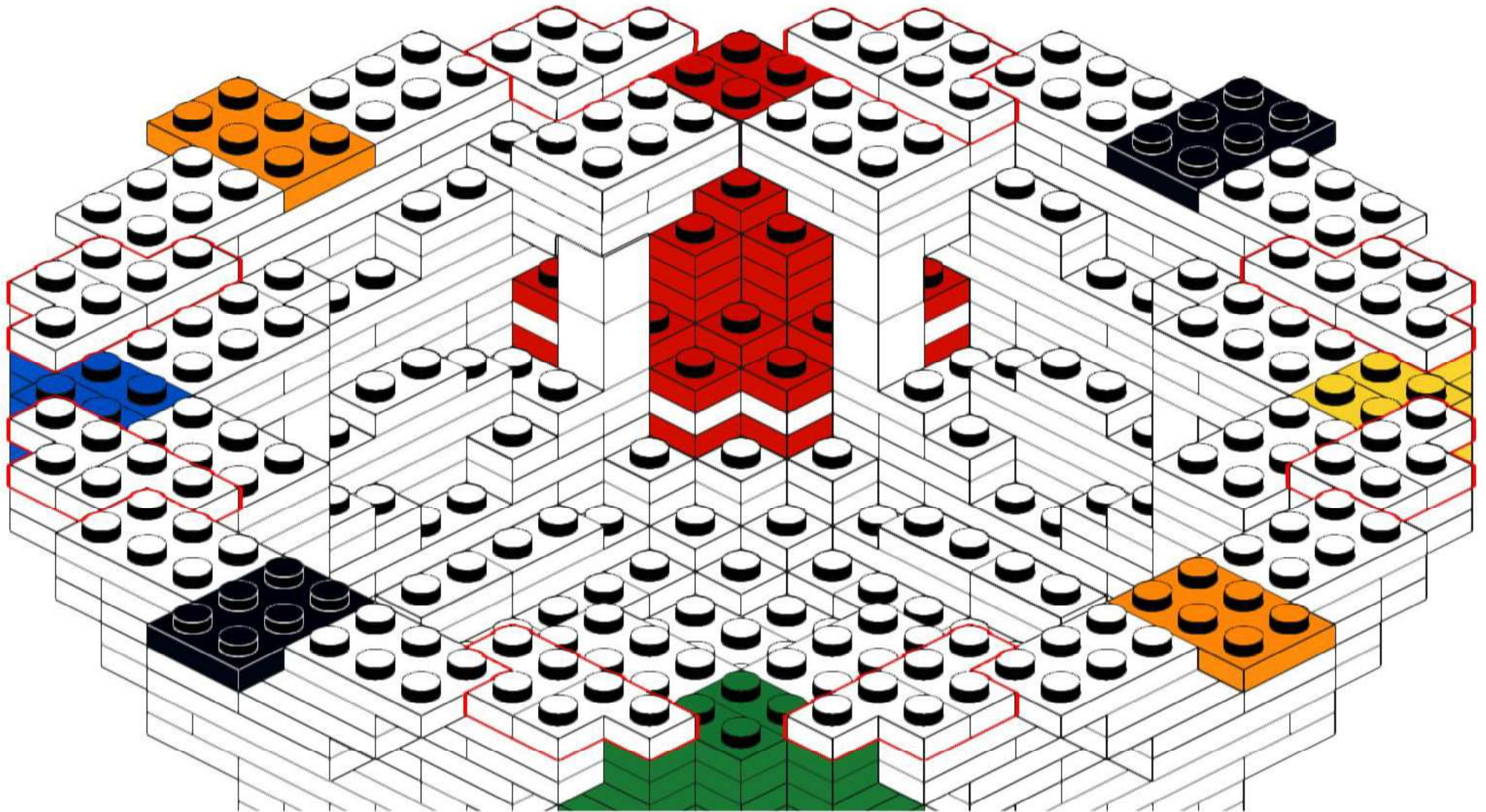
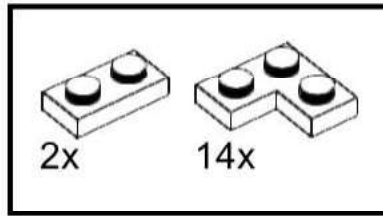

74

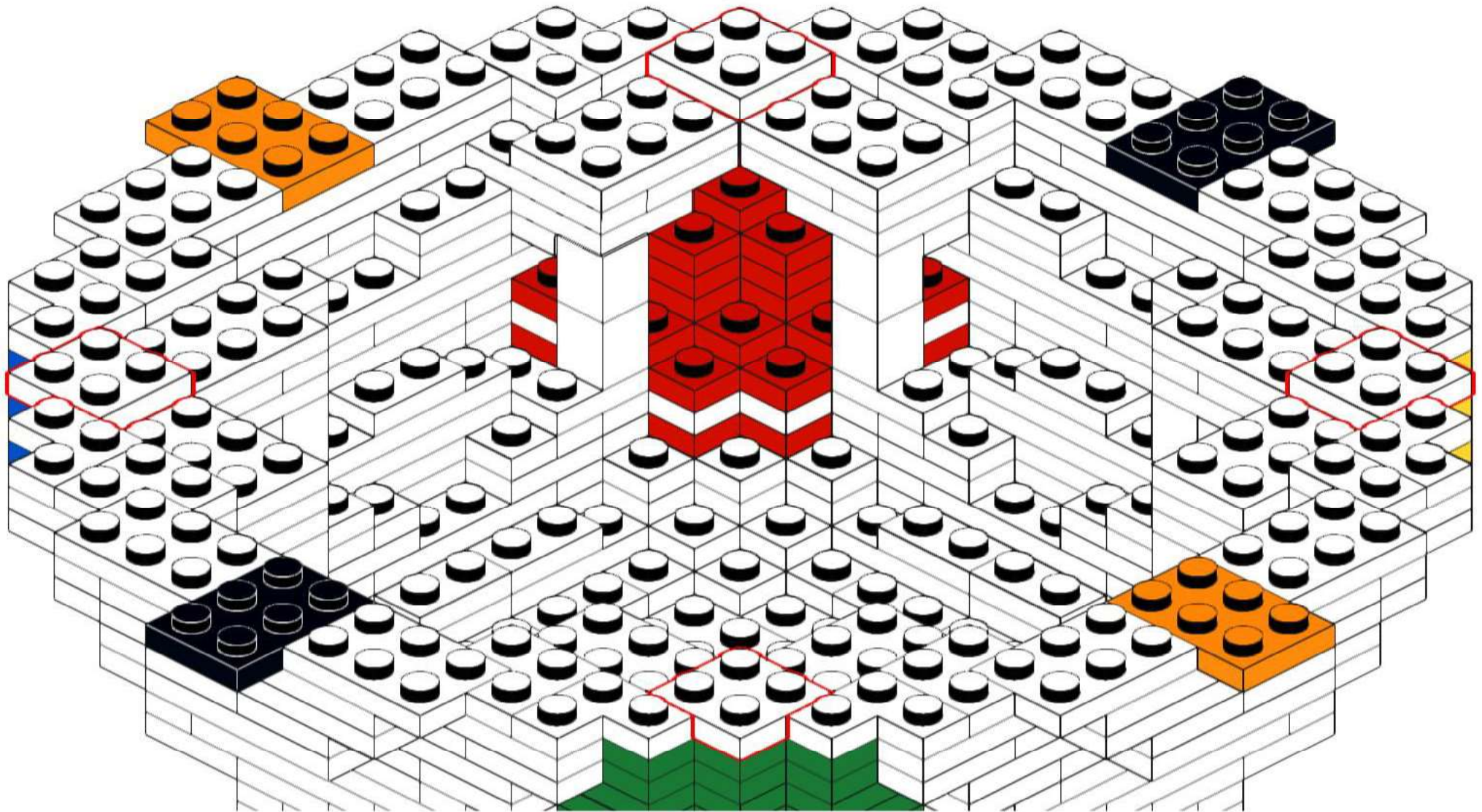
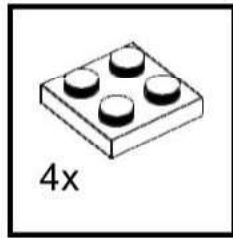

75

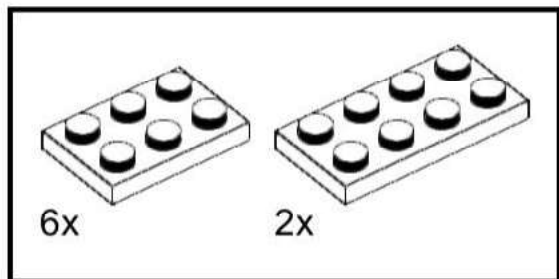

Hinten Back

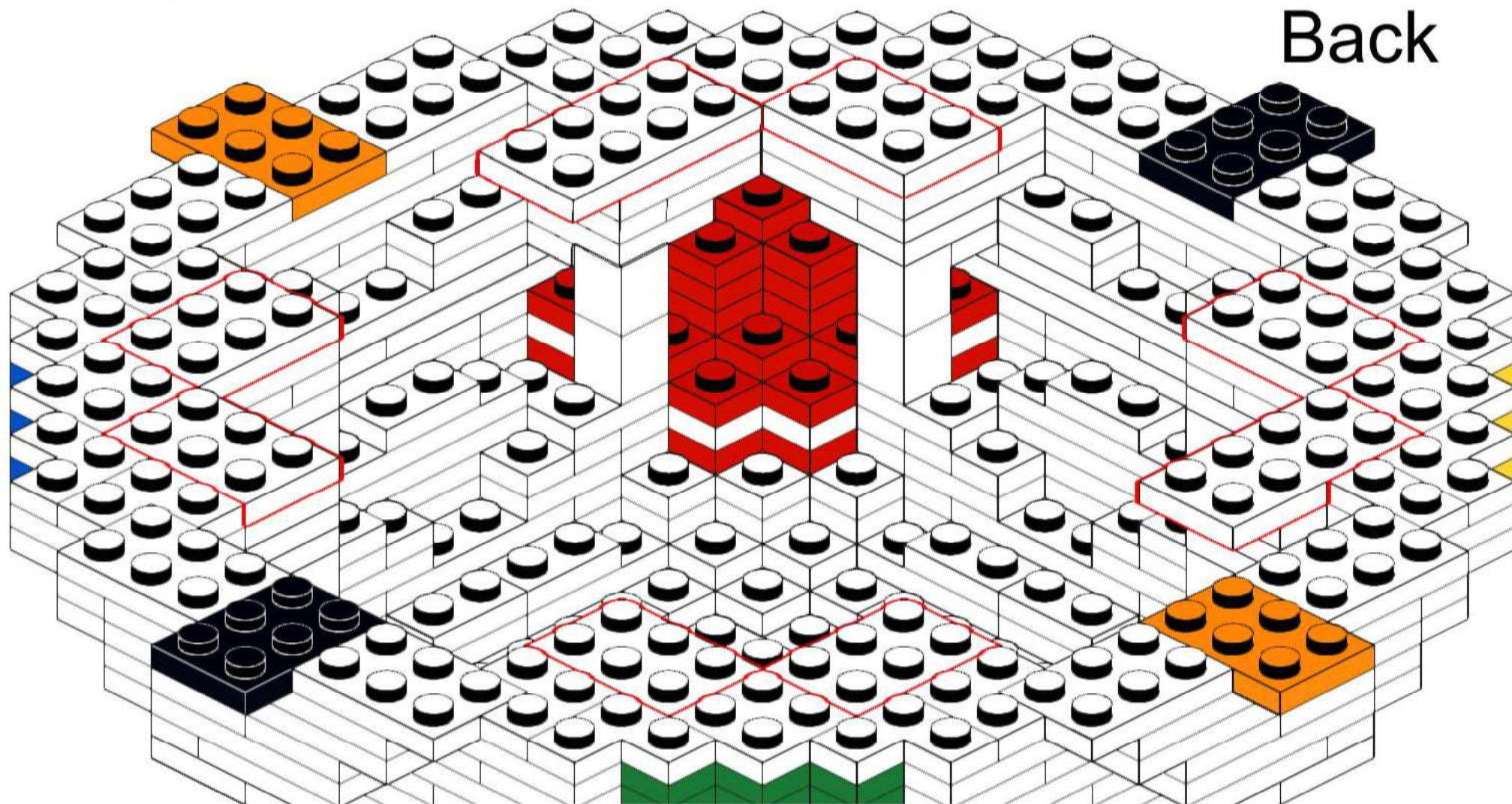

76

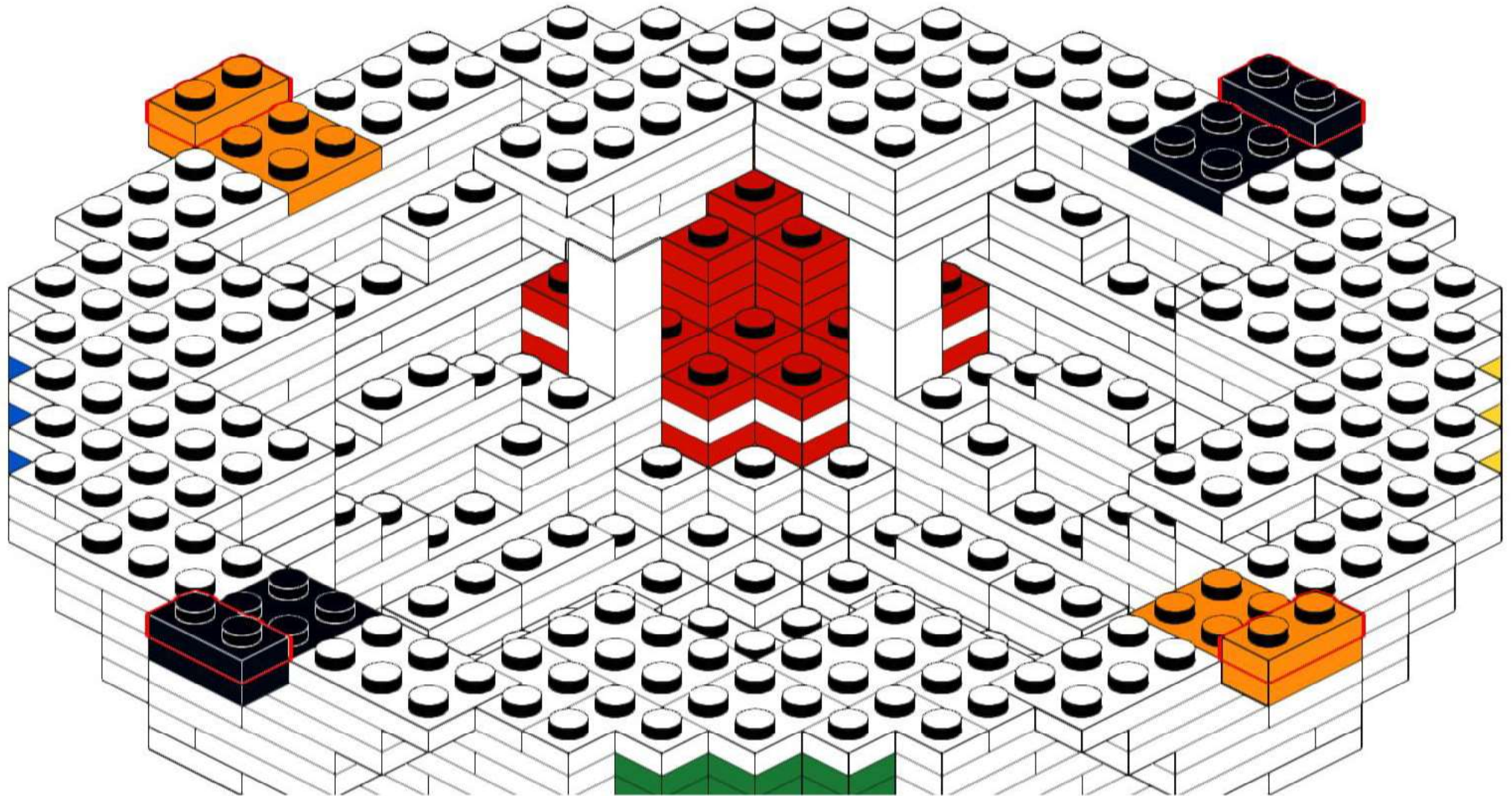
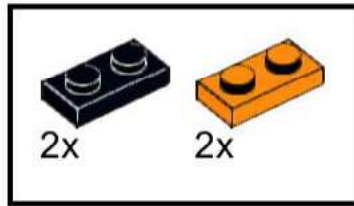

77

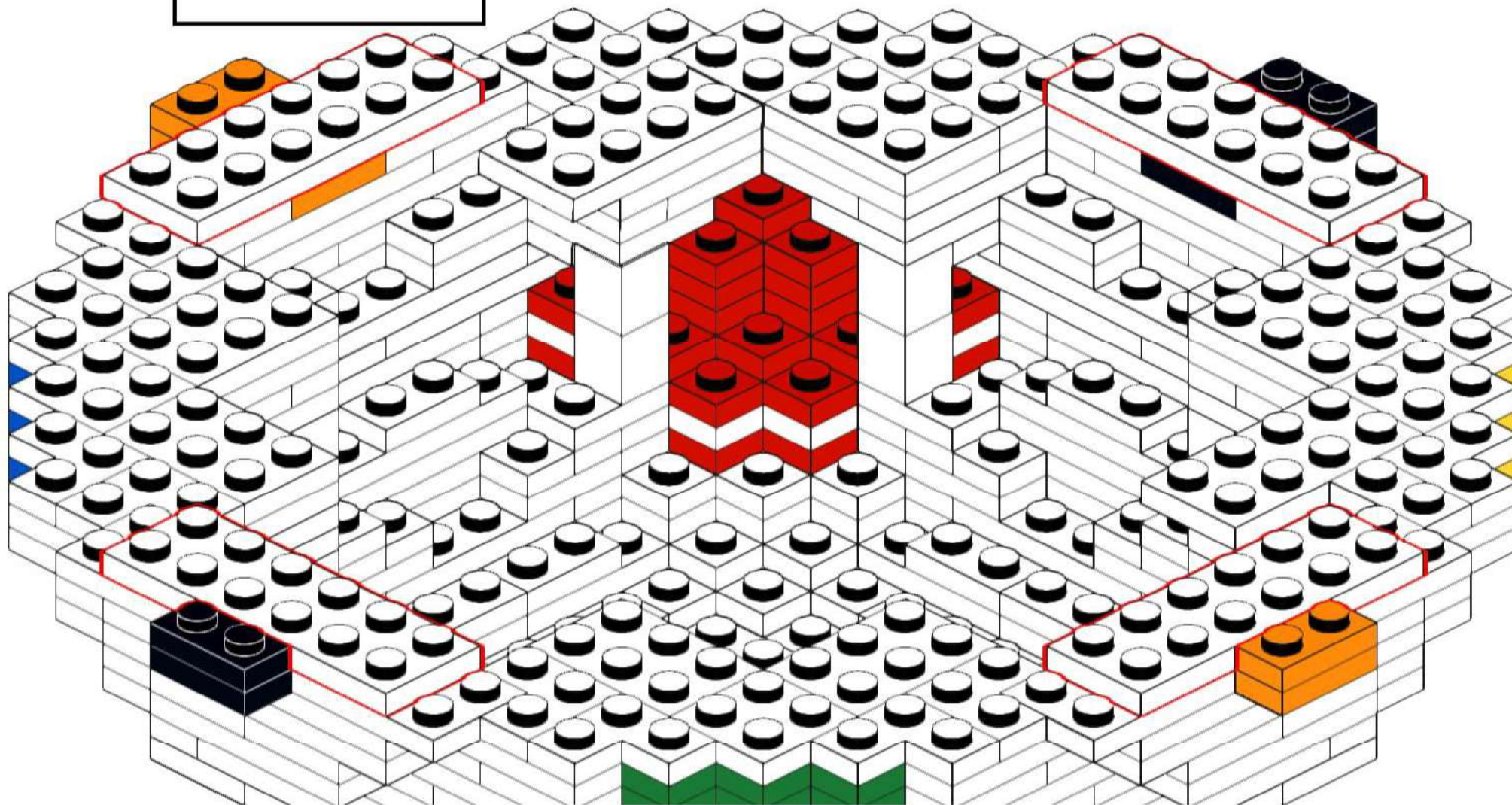
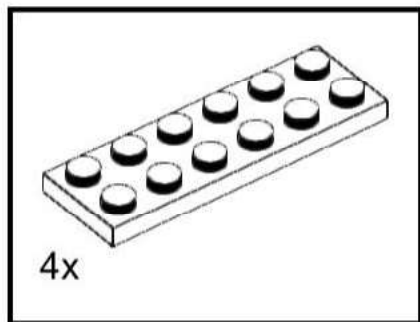

78

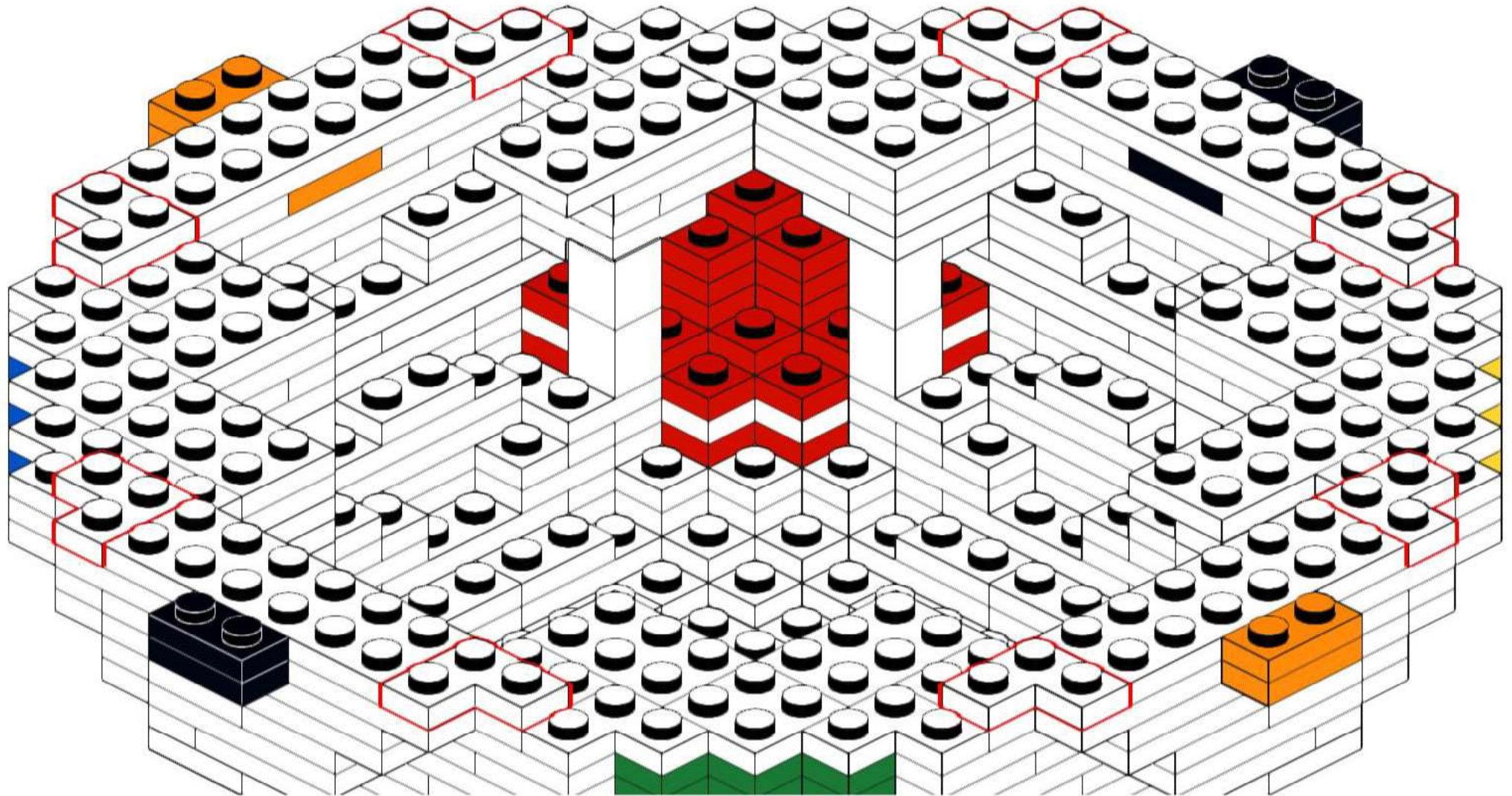
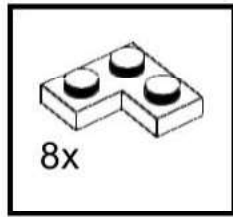

79

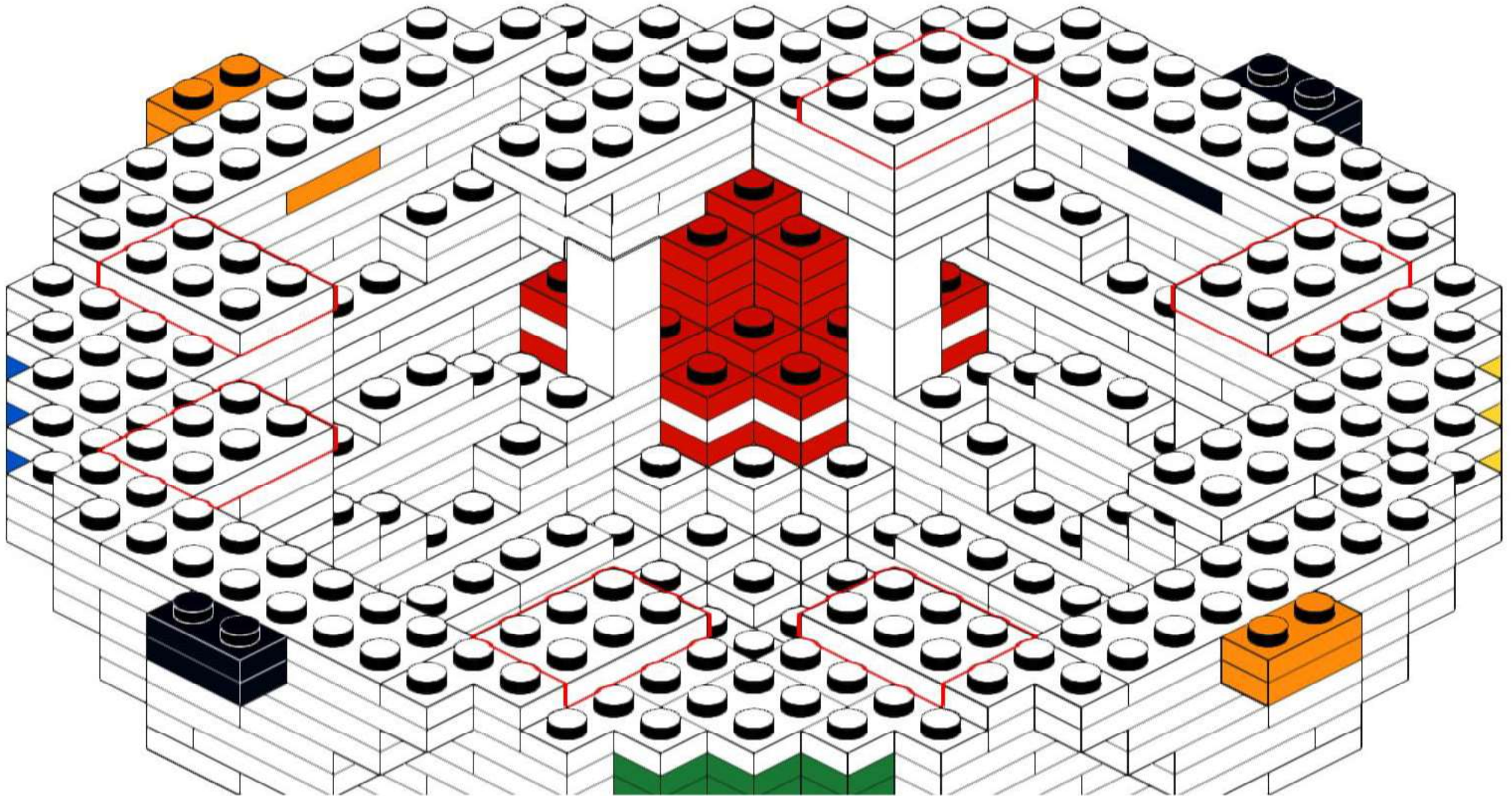
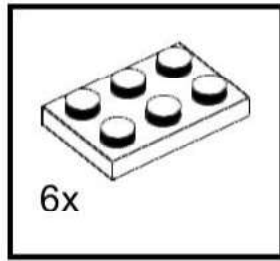

80

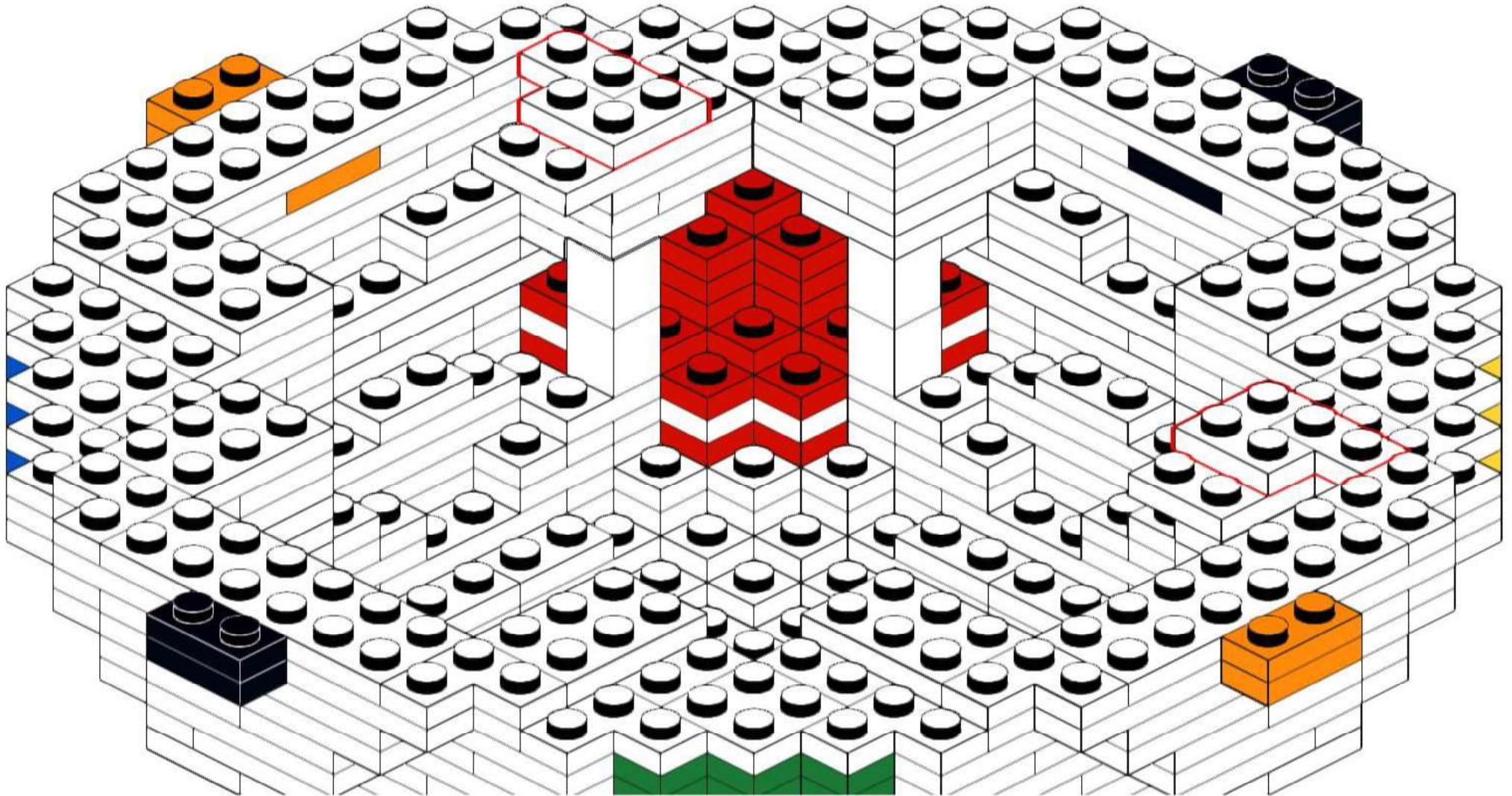
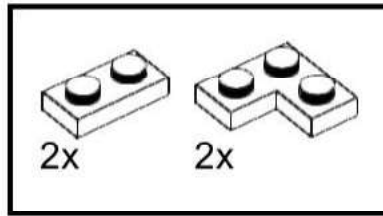

81

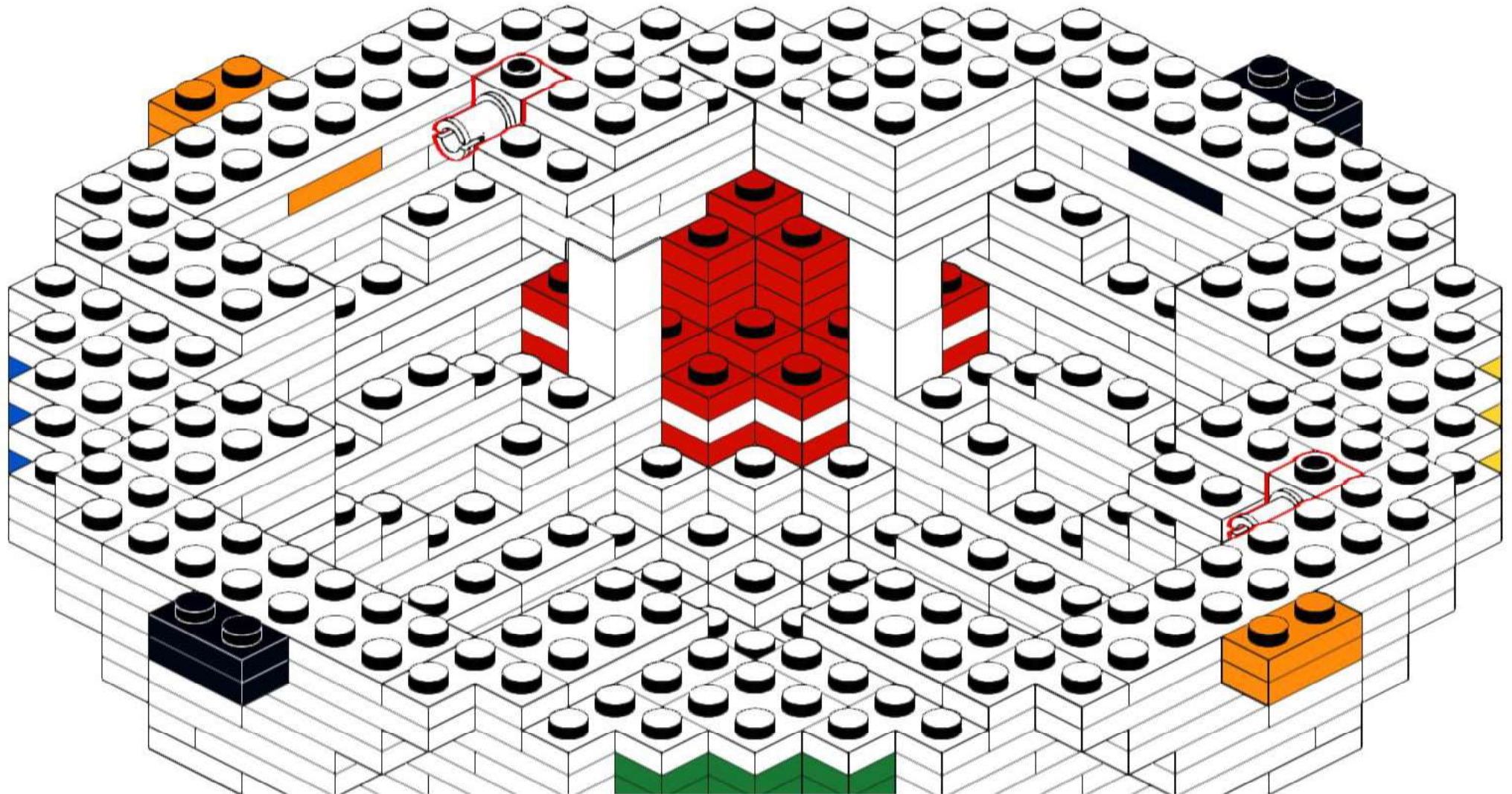
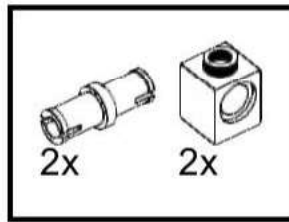

82

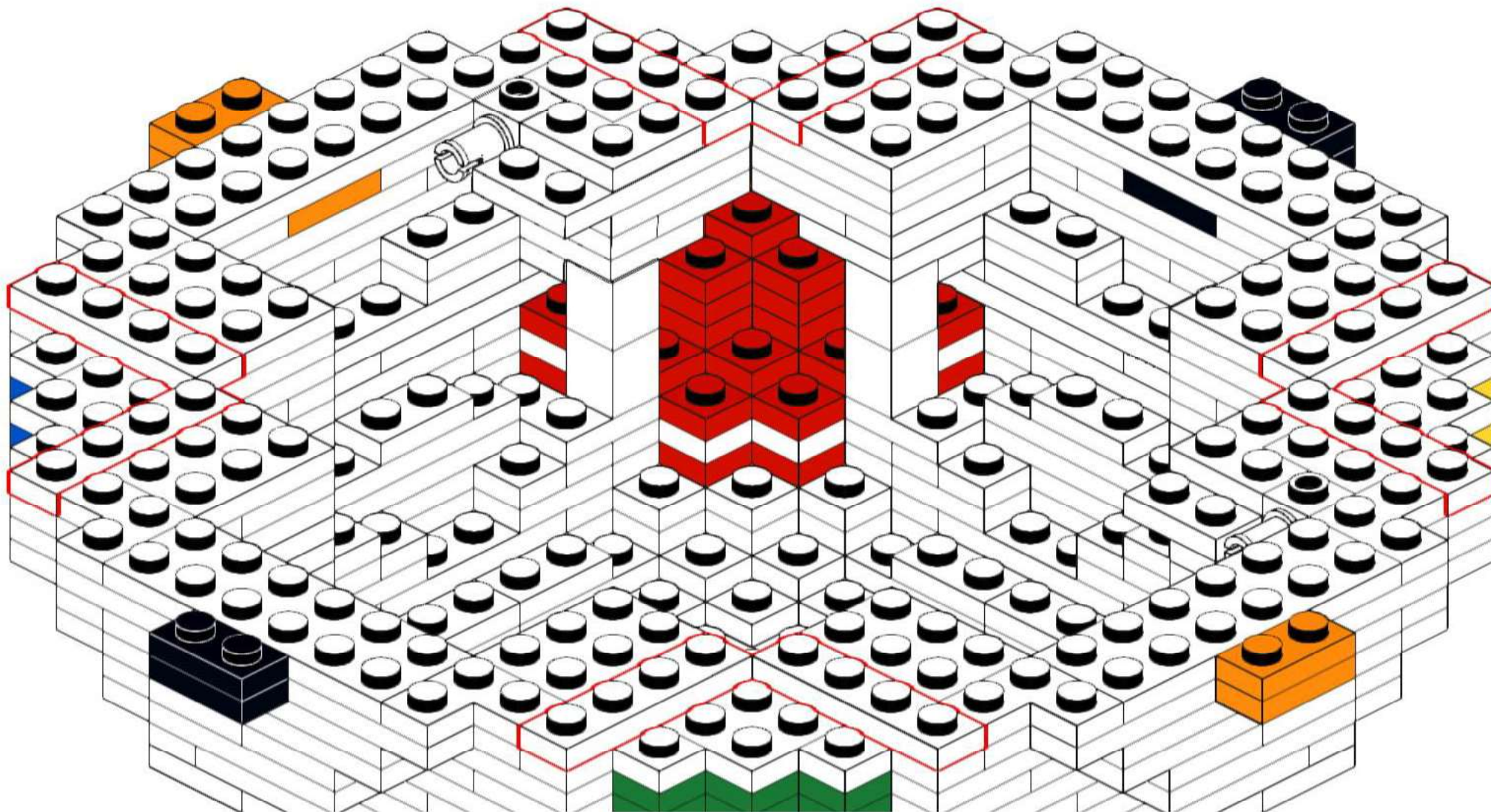
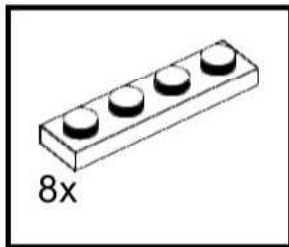

83

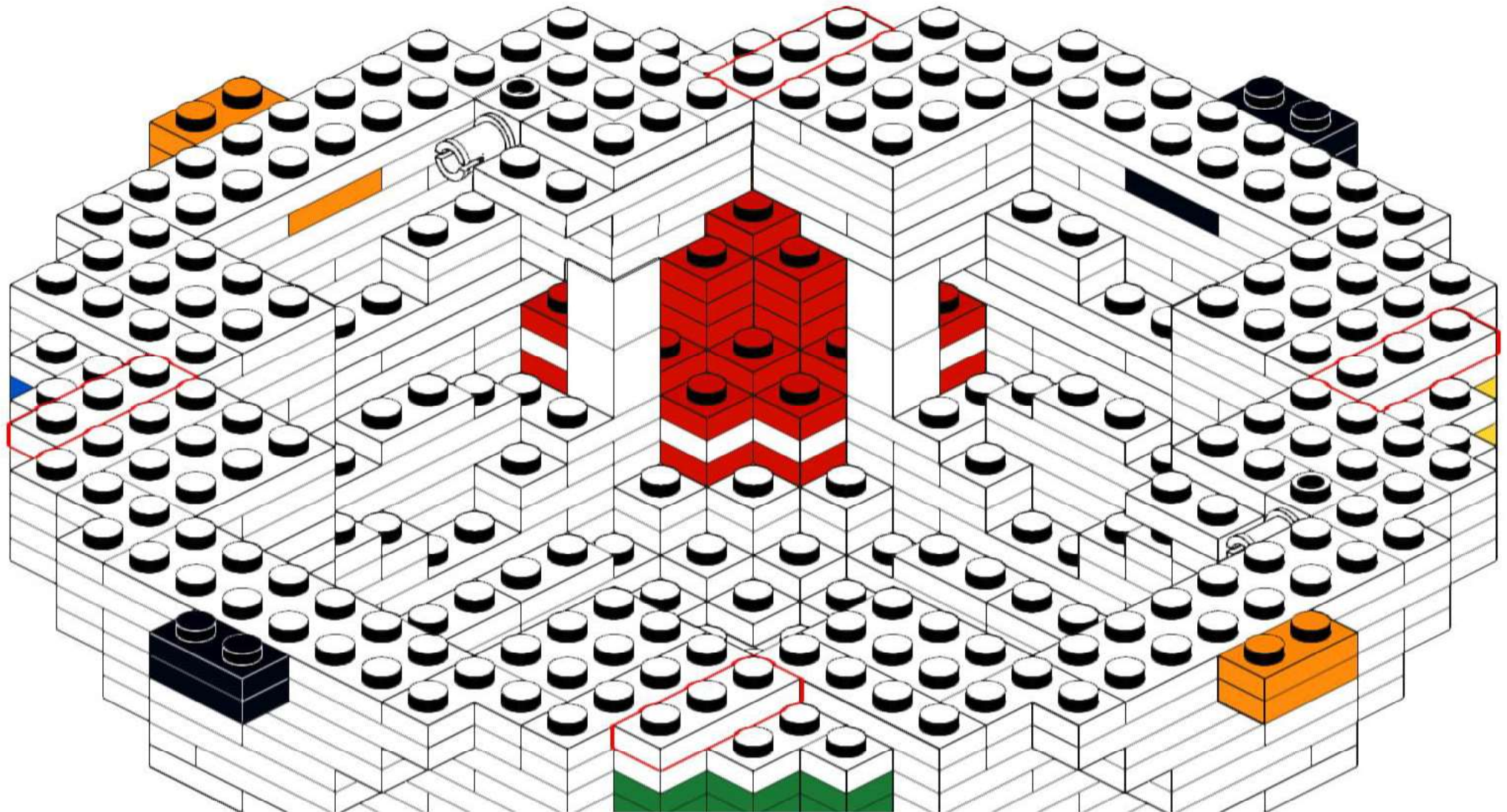
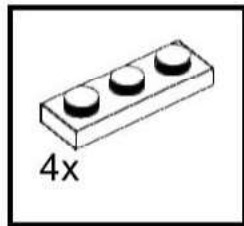

84

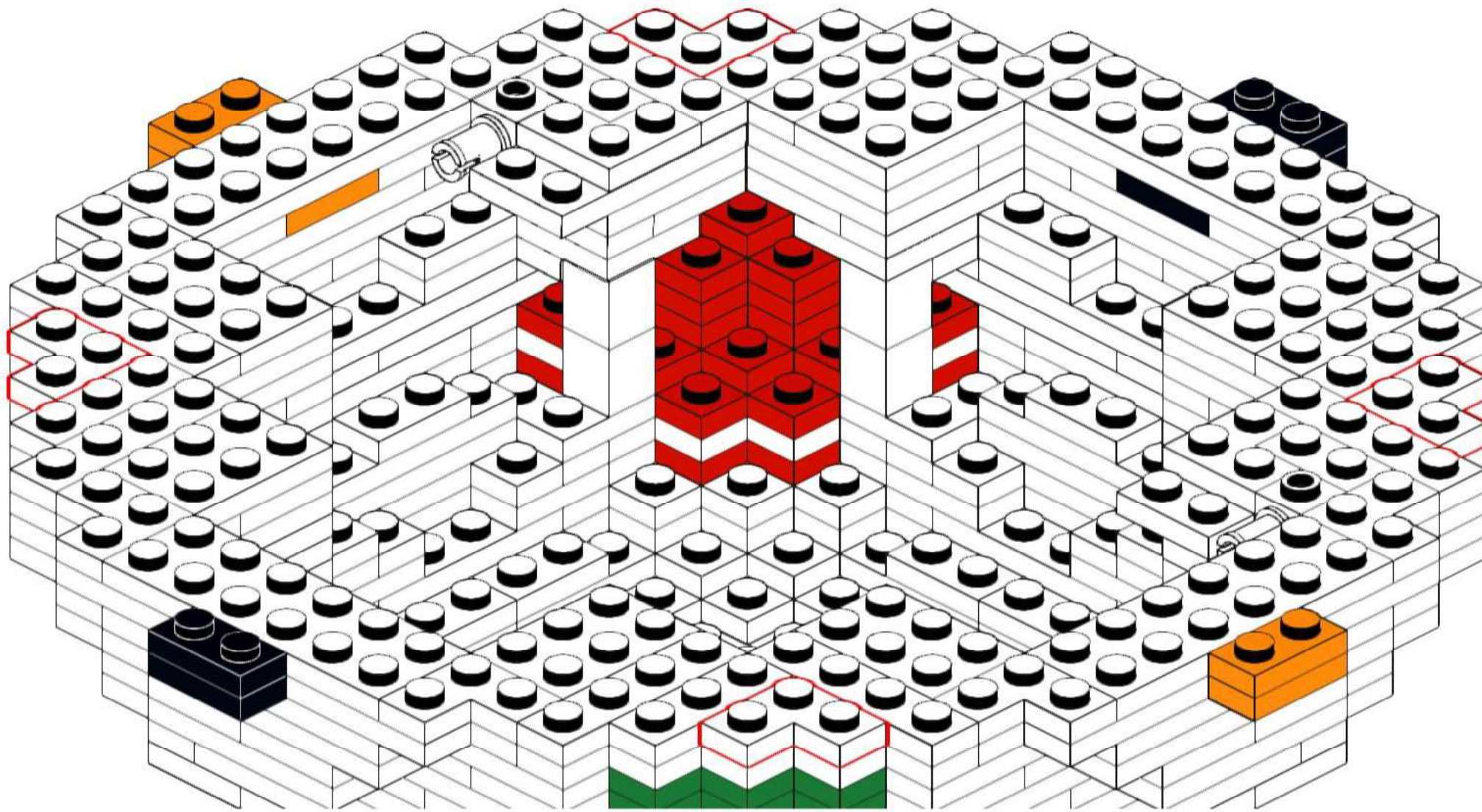
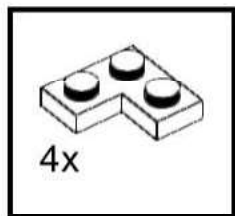

85

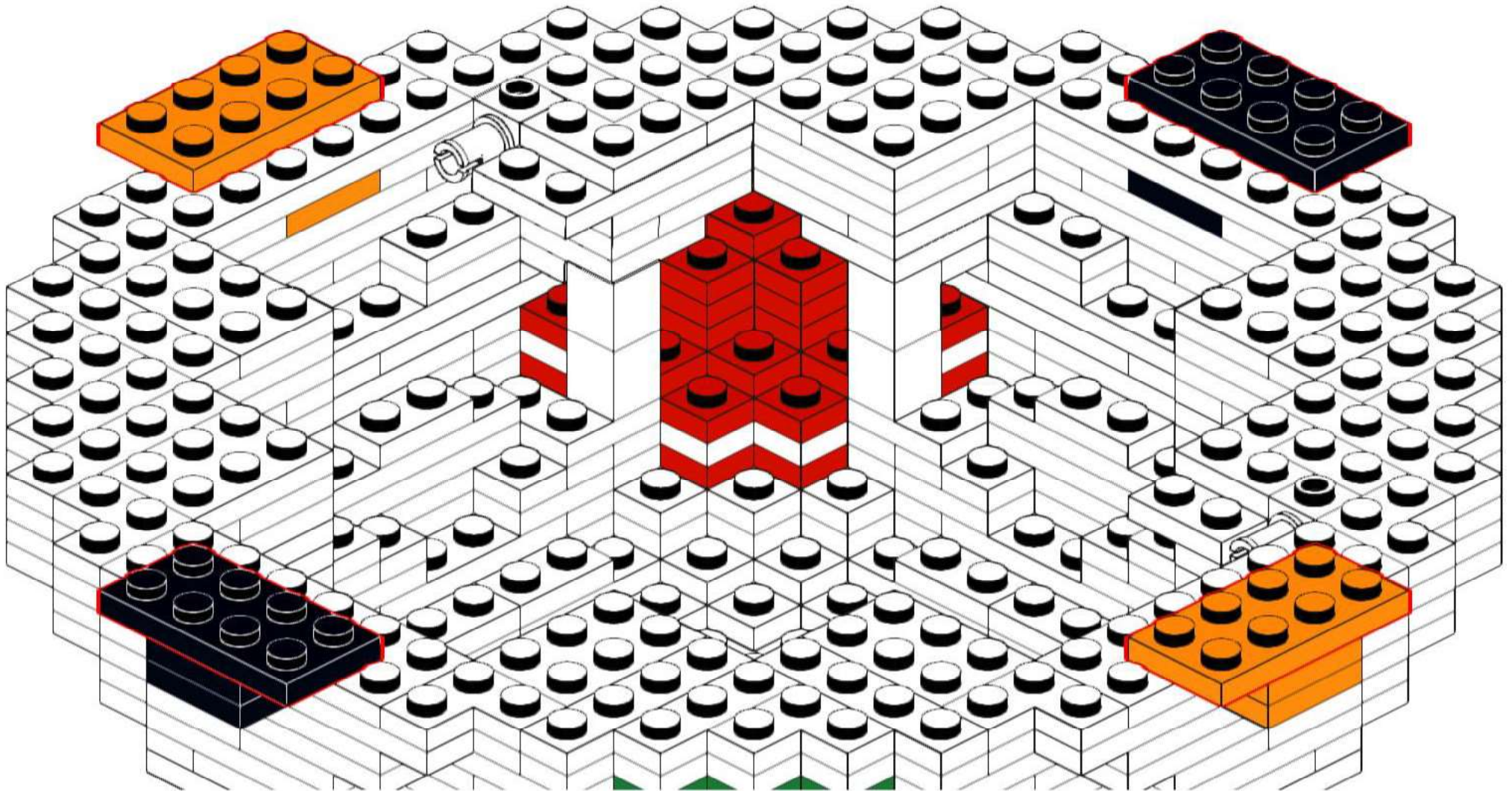
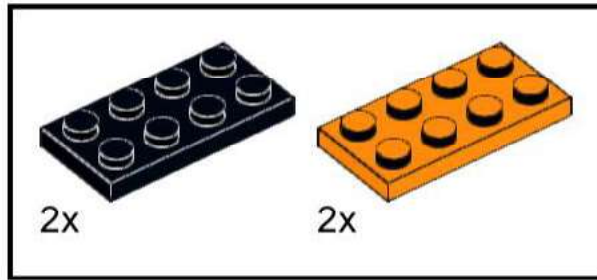

86

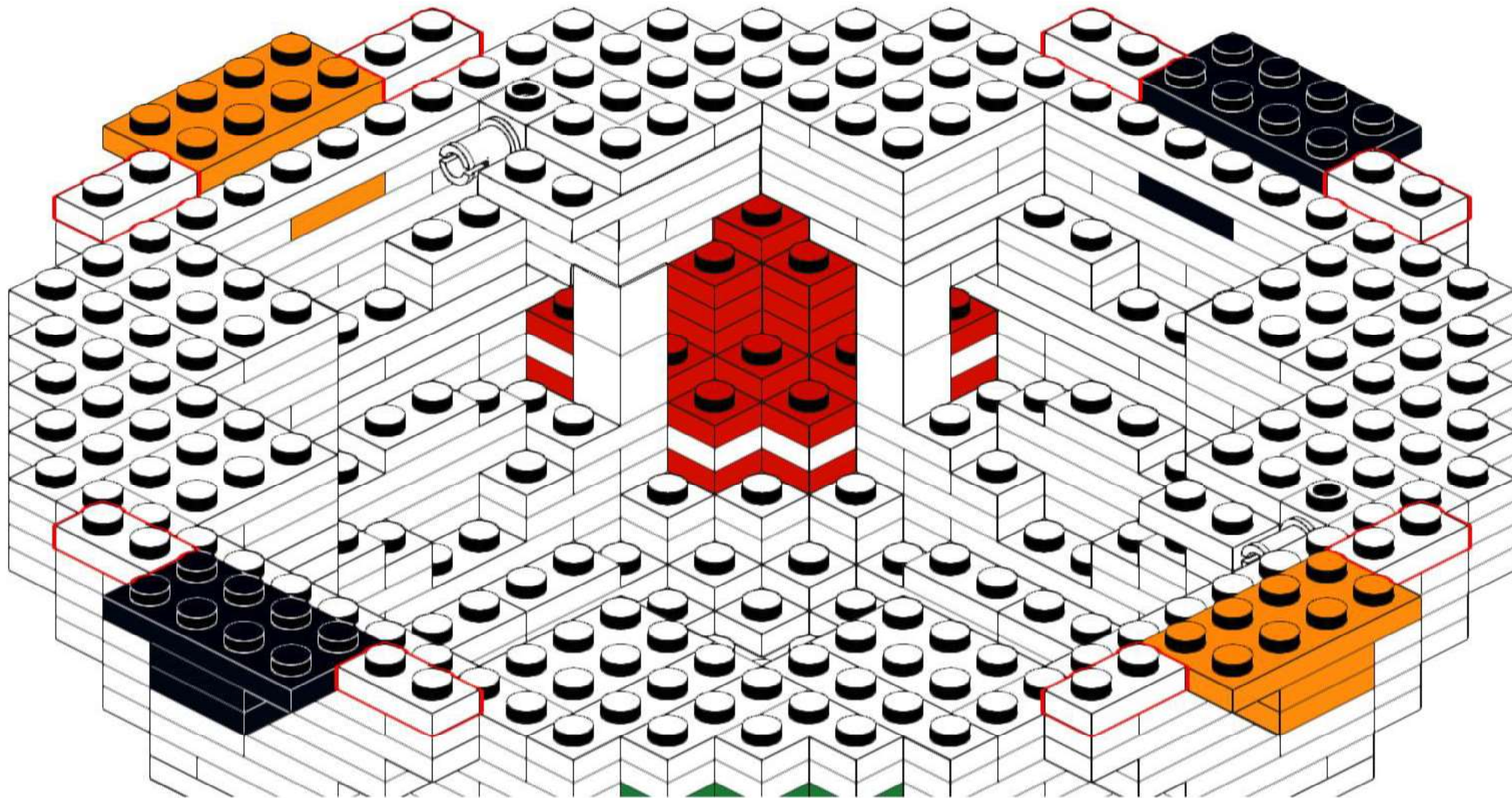
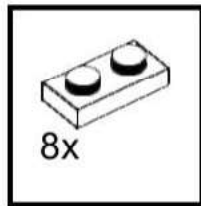

87

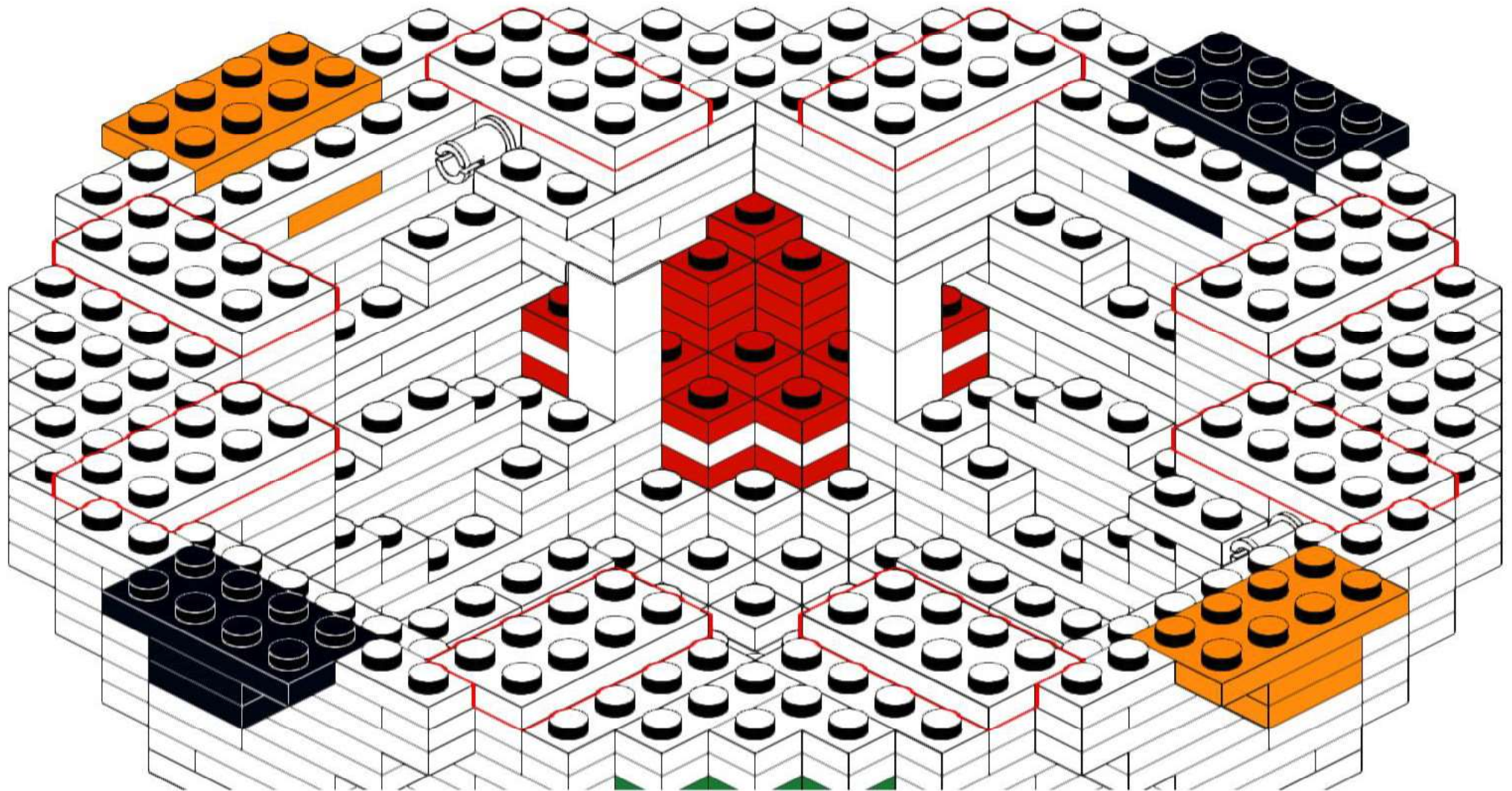
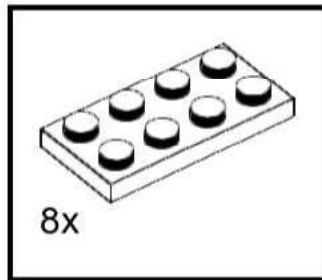

88

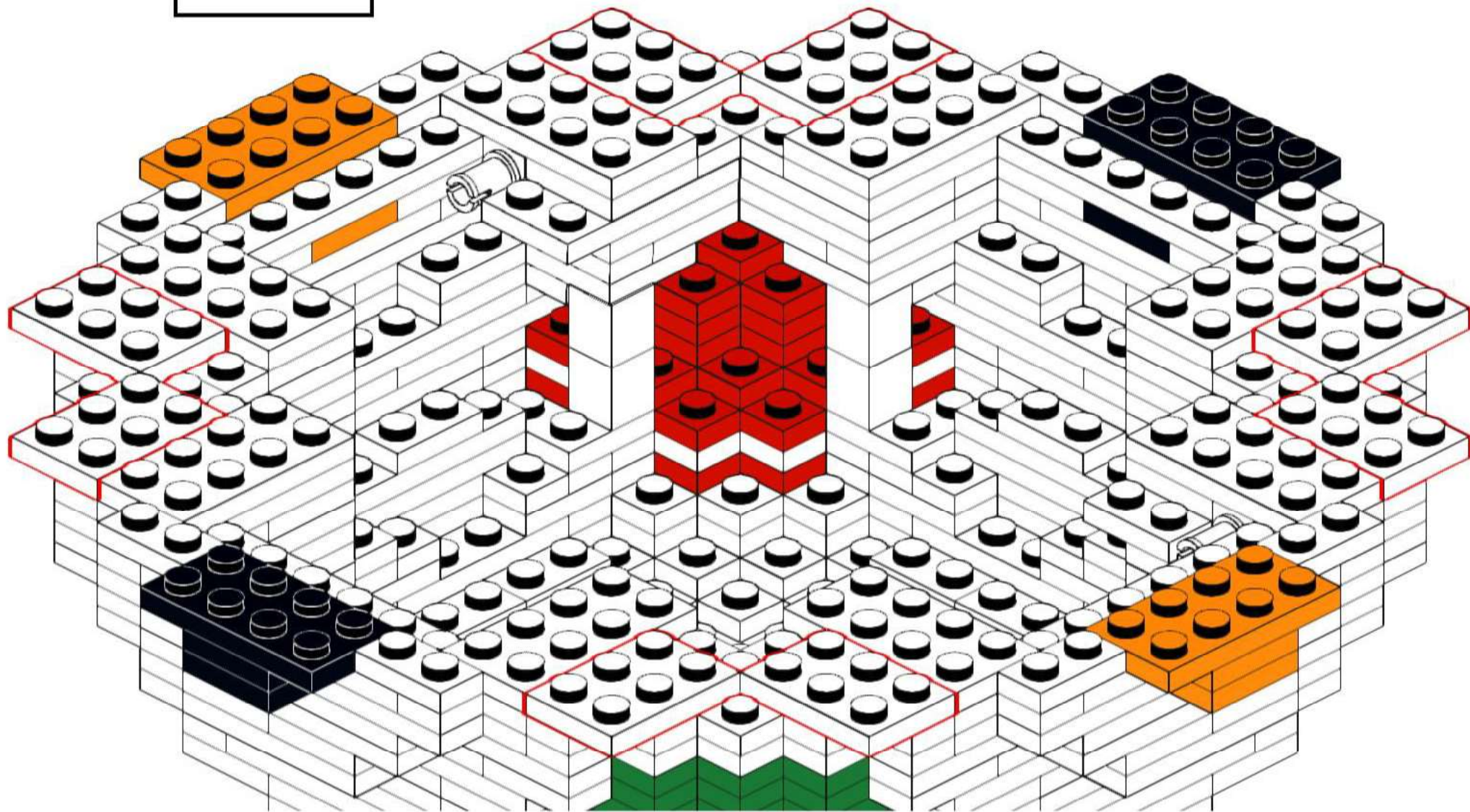
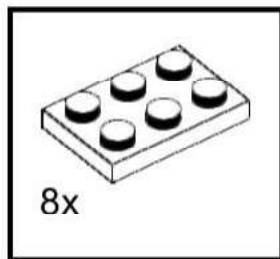

89

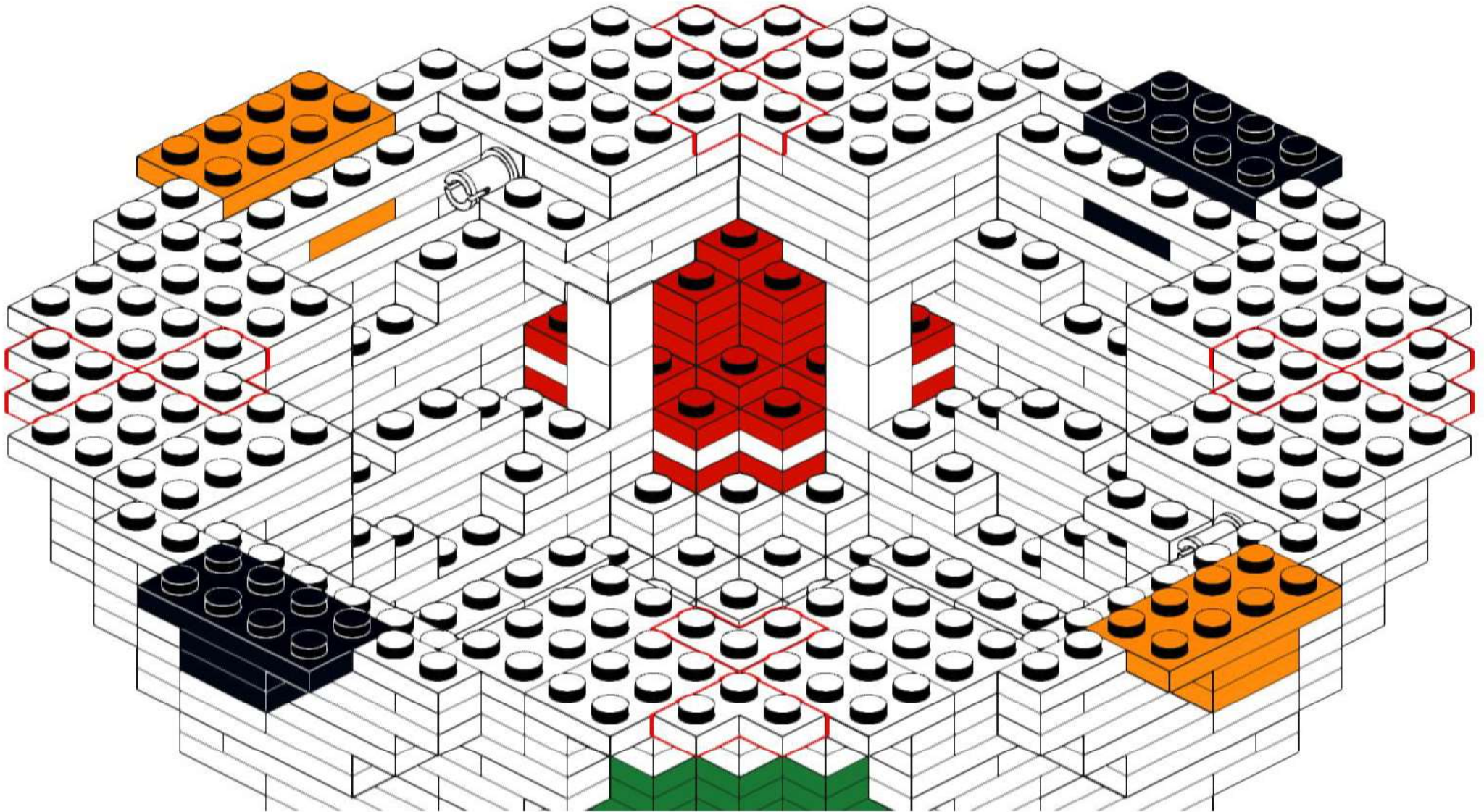
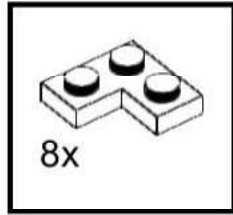

90

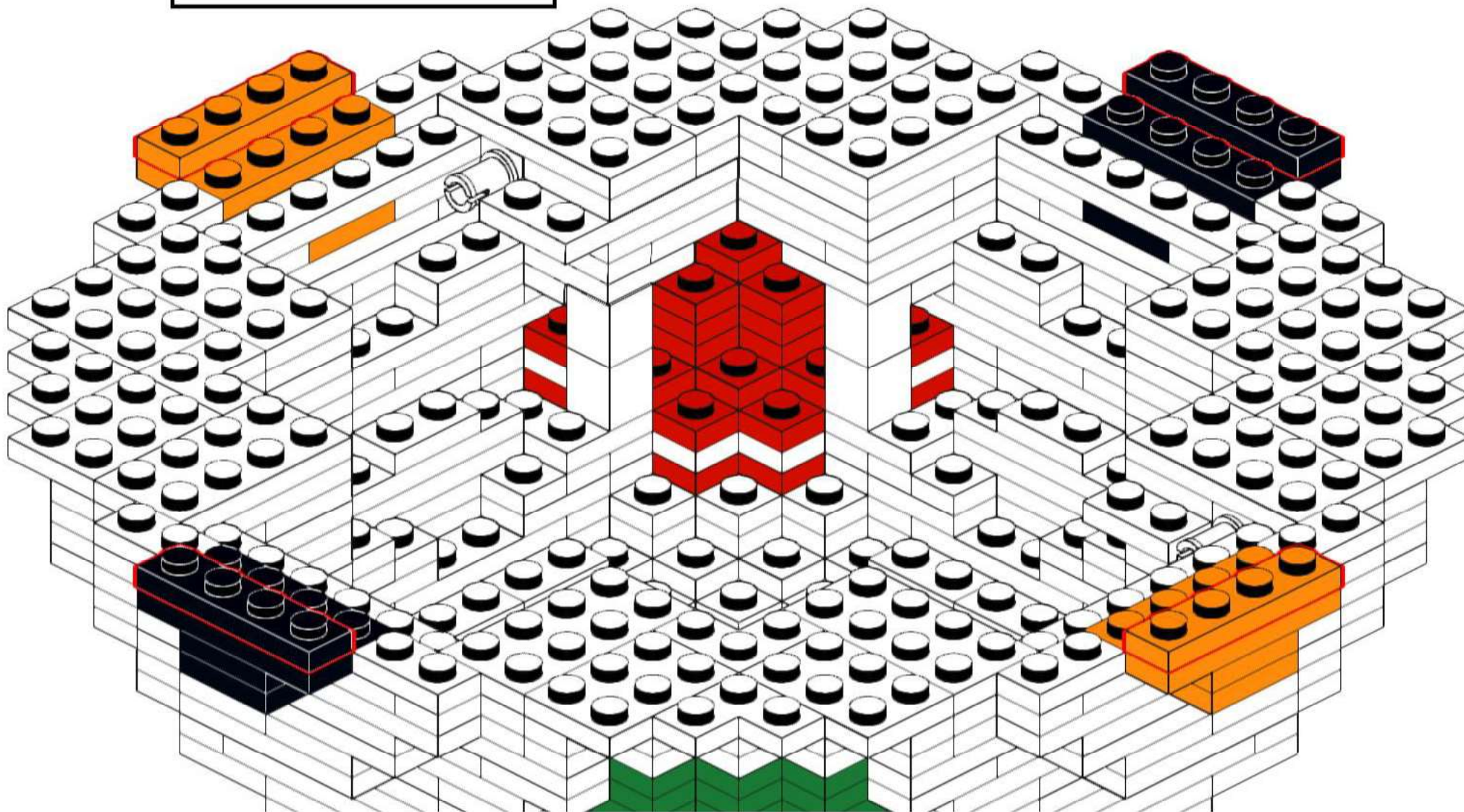
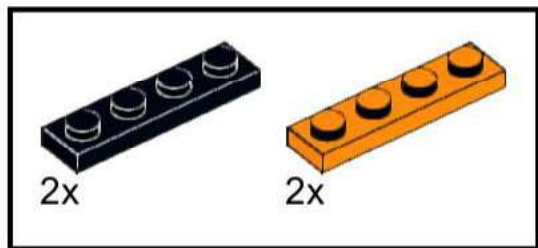

91

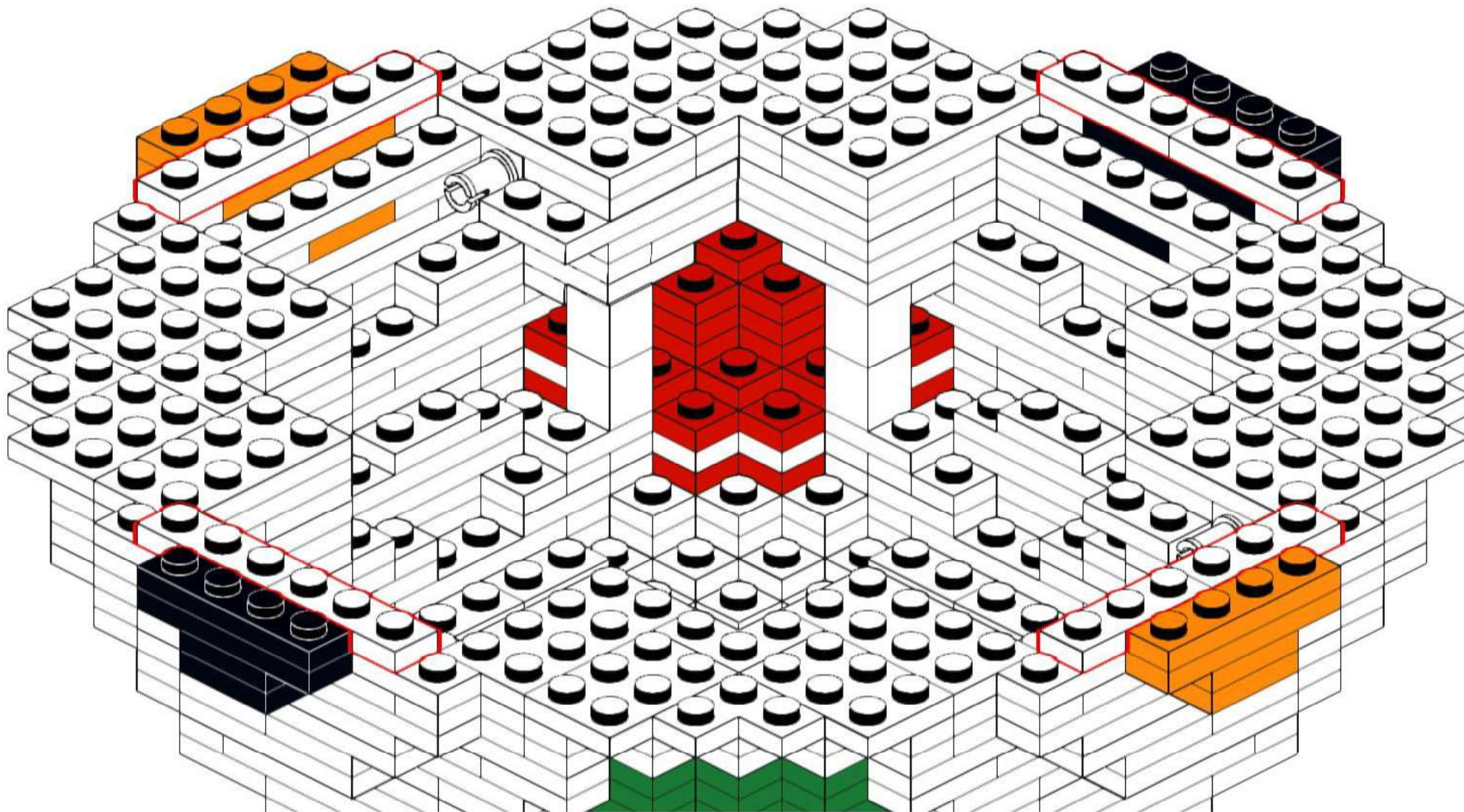
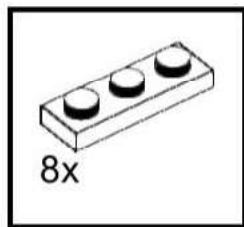

92

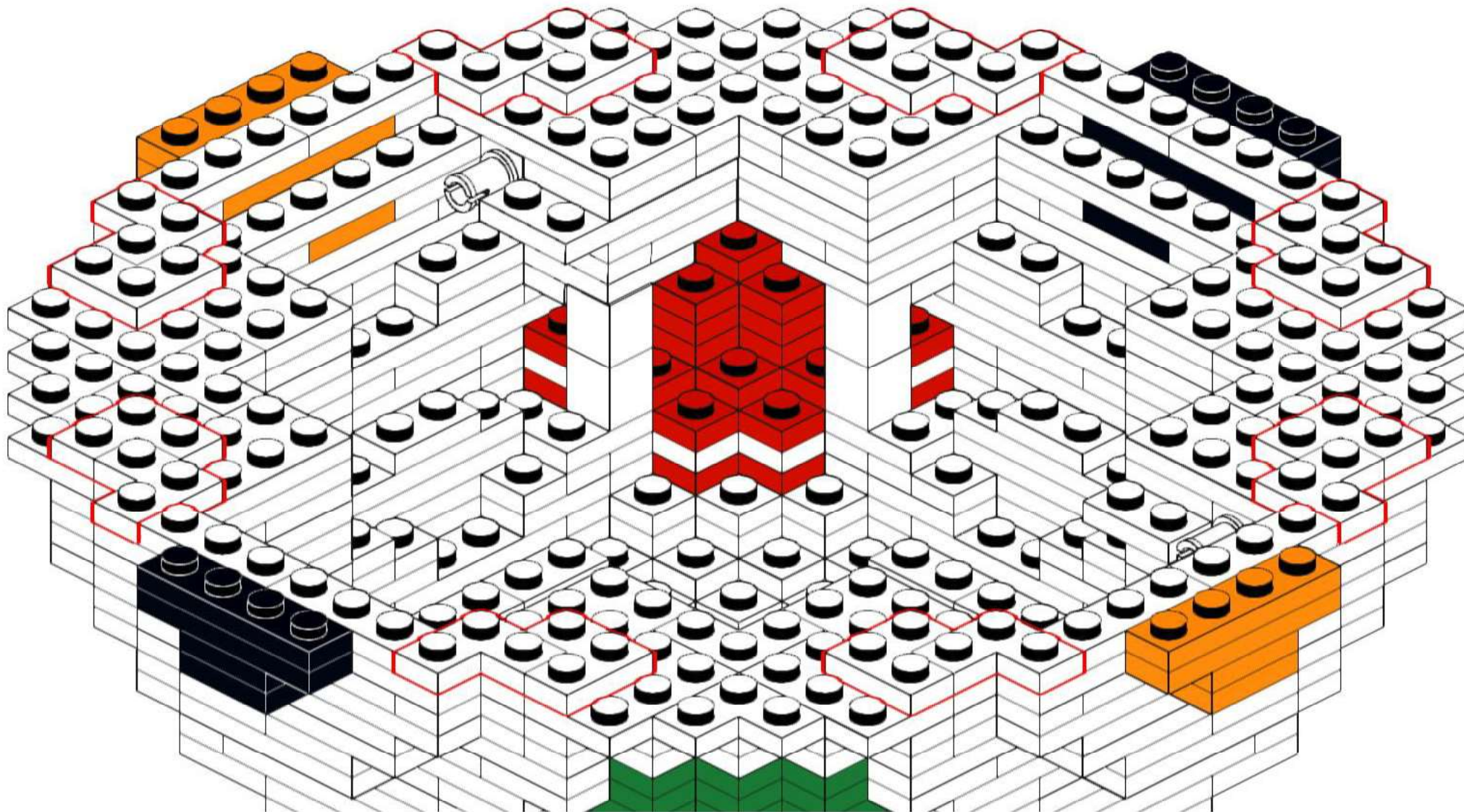
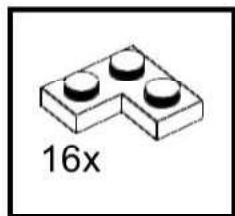

93

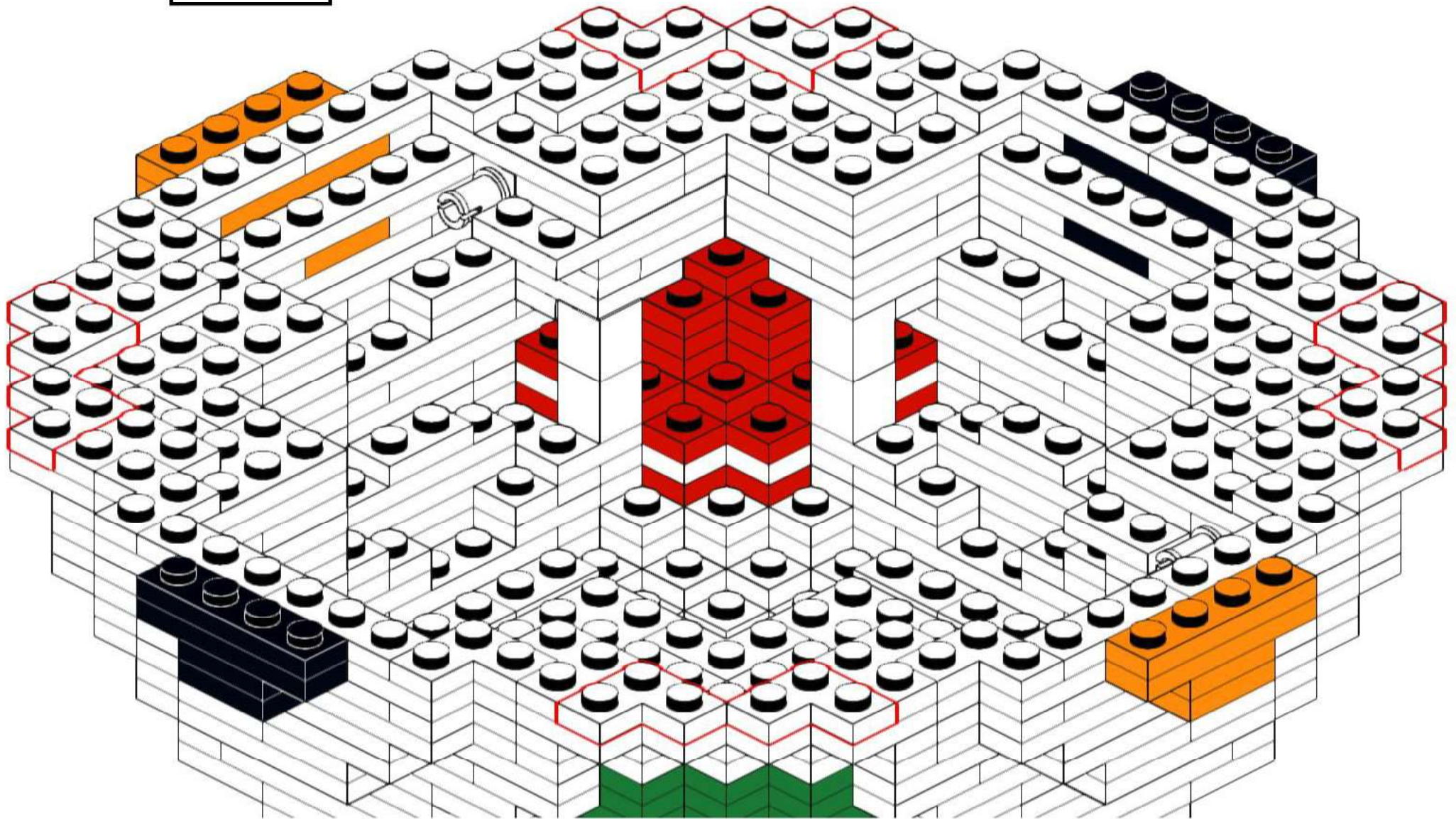
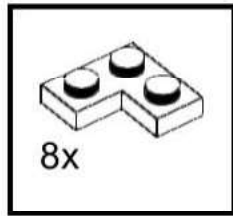

94

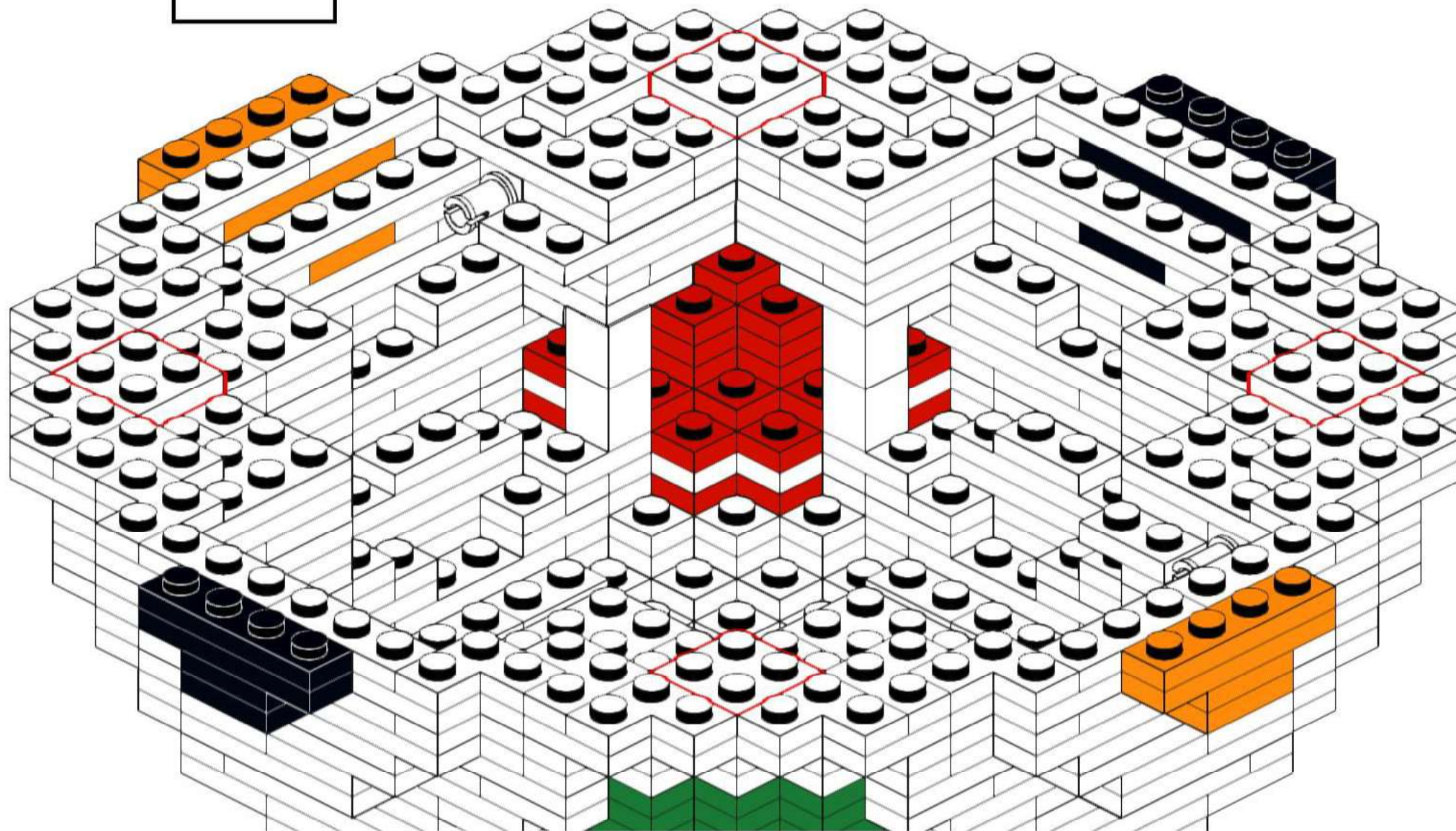
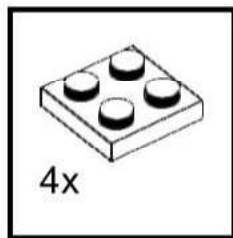

95

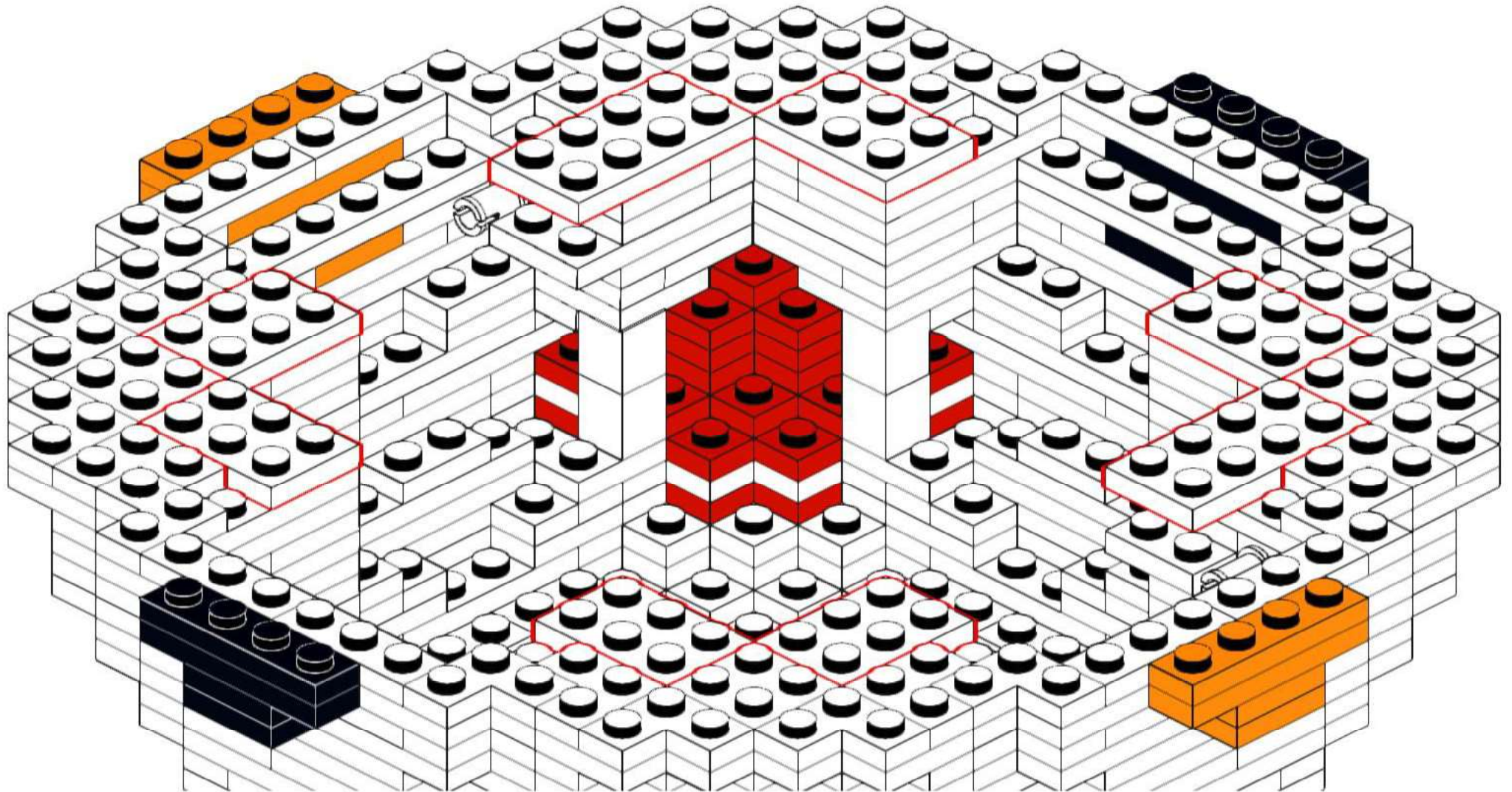
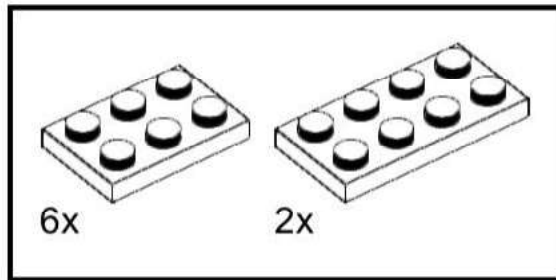

96

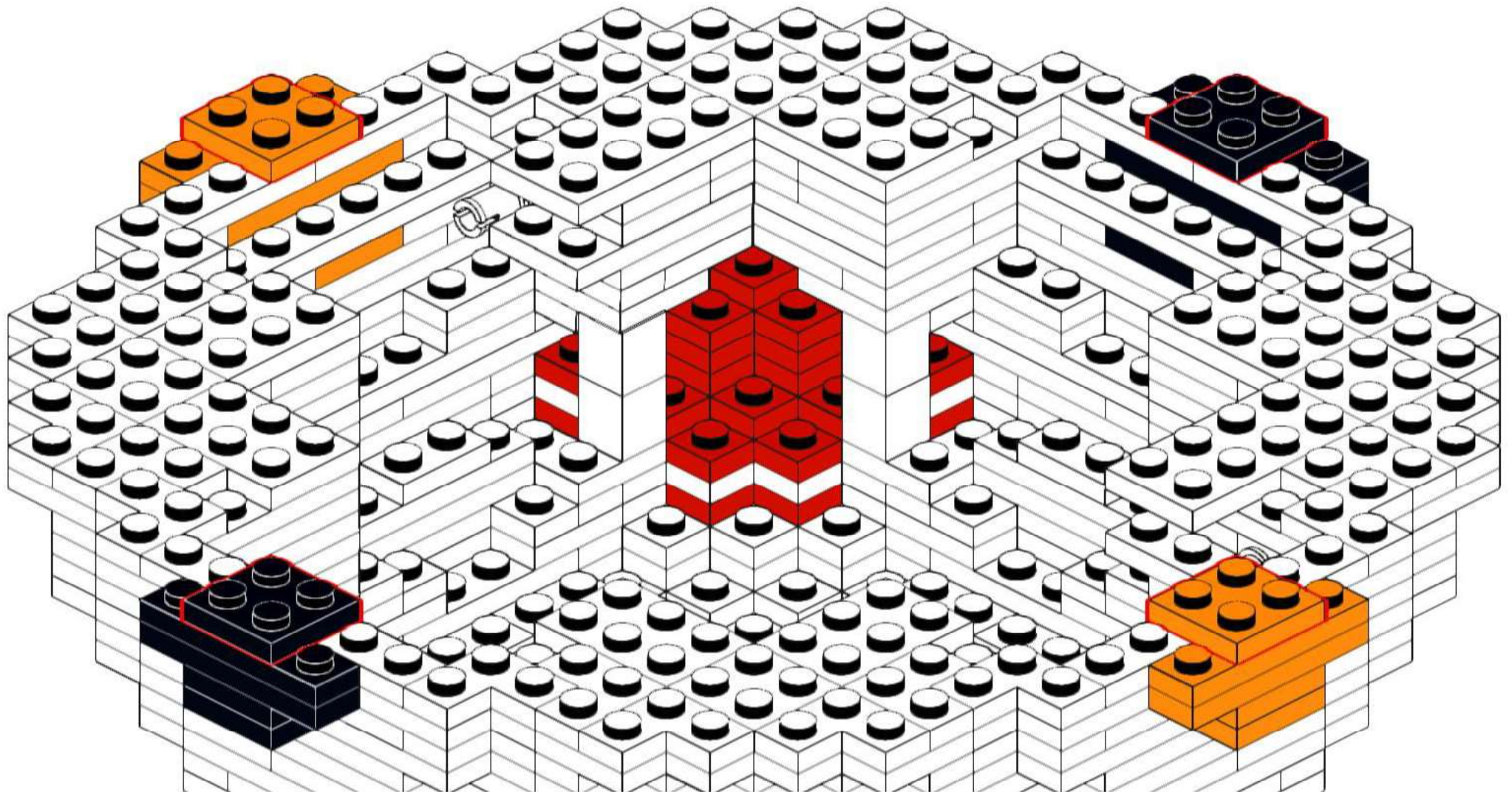
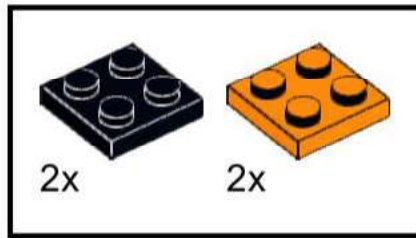

97

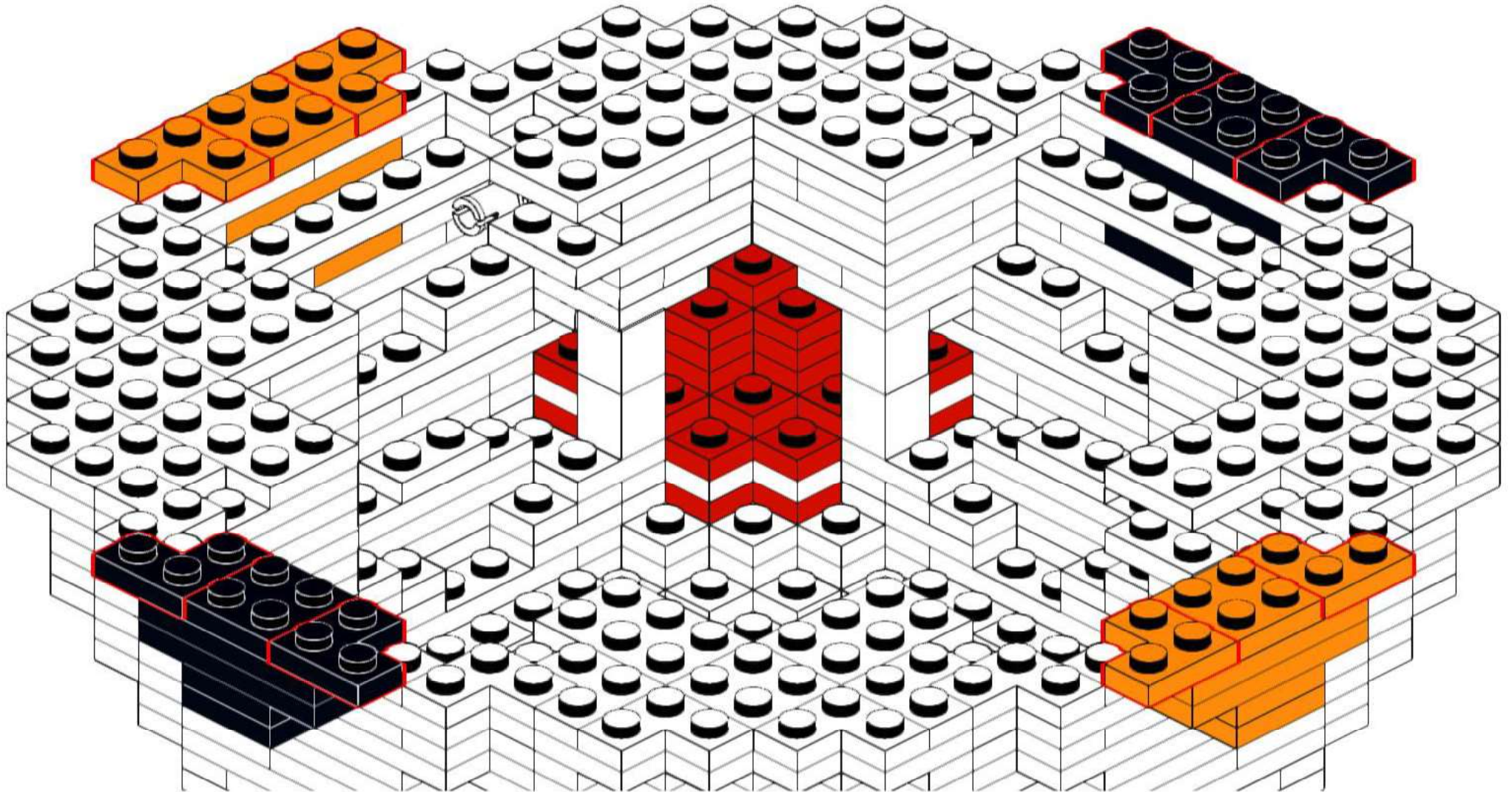
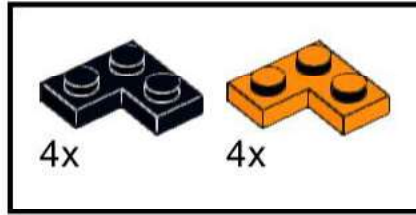

98

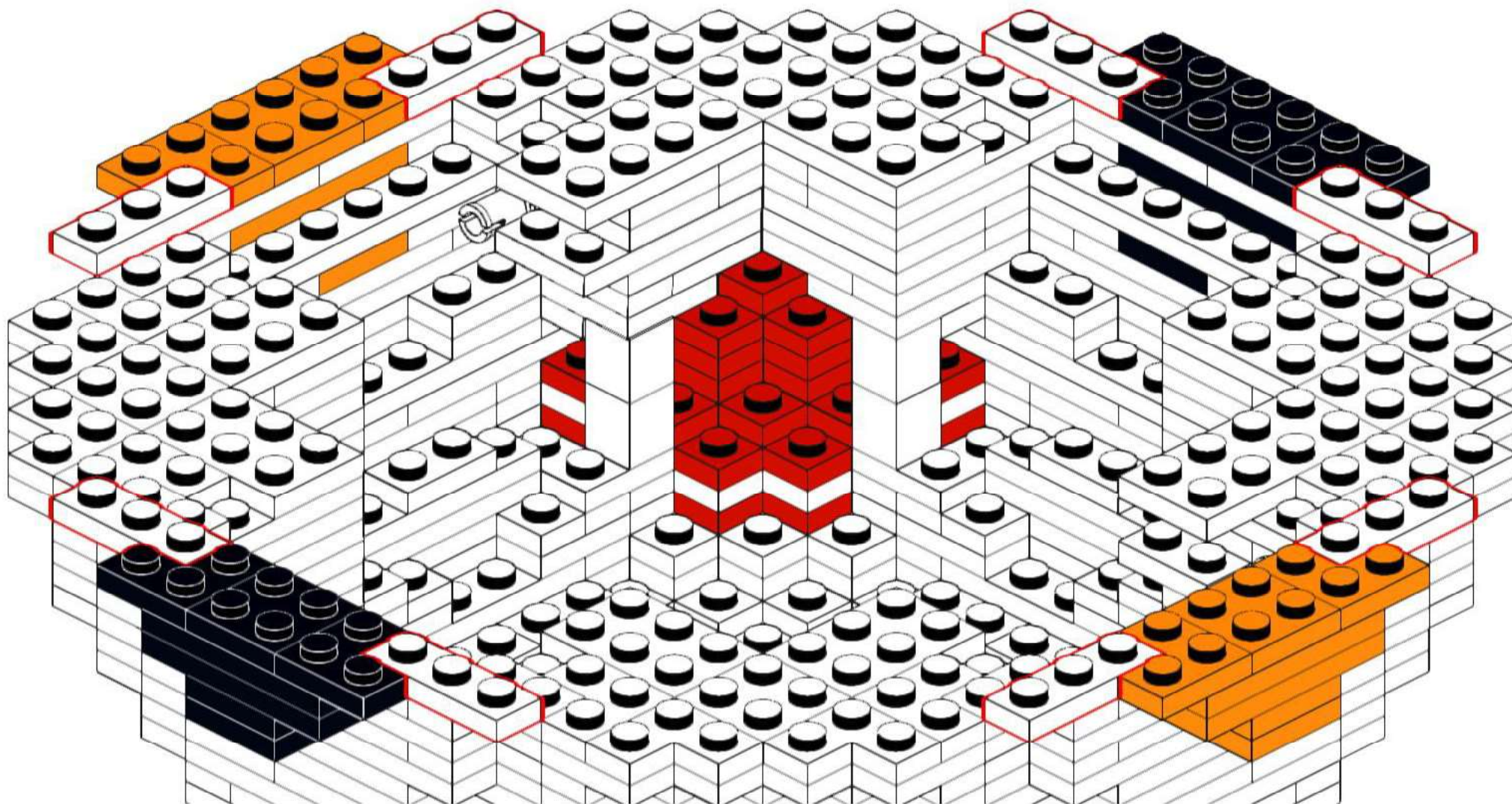
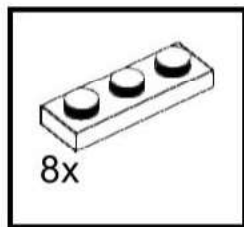

99

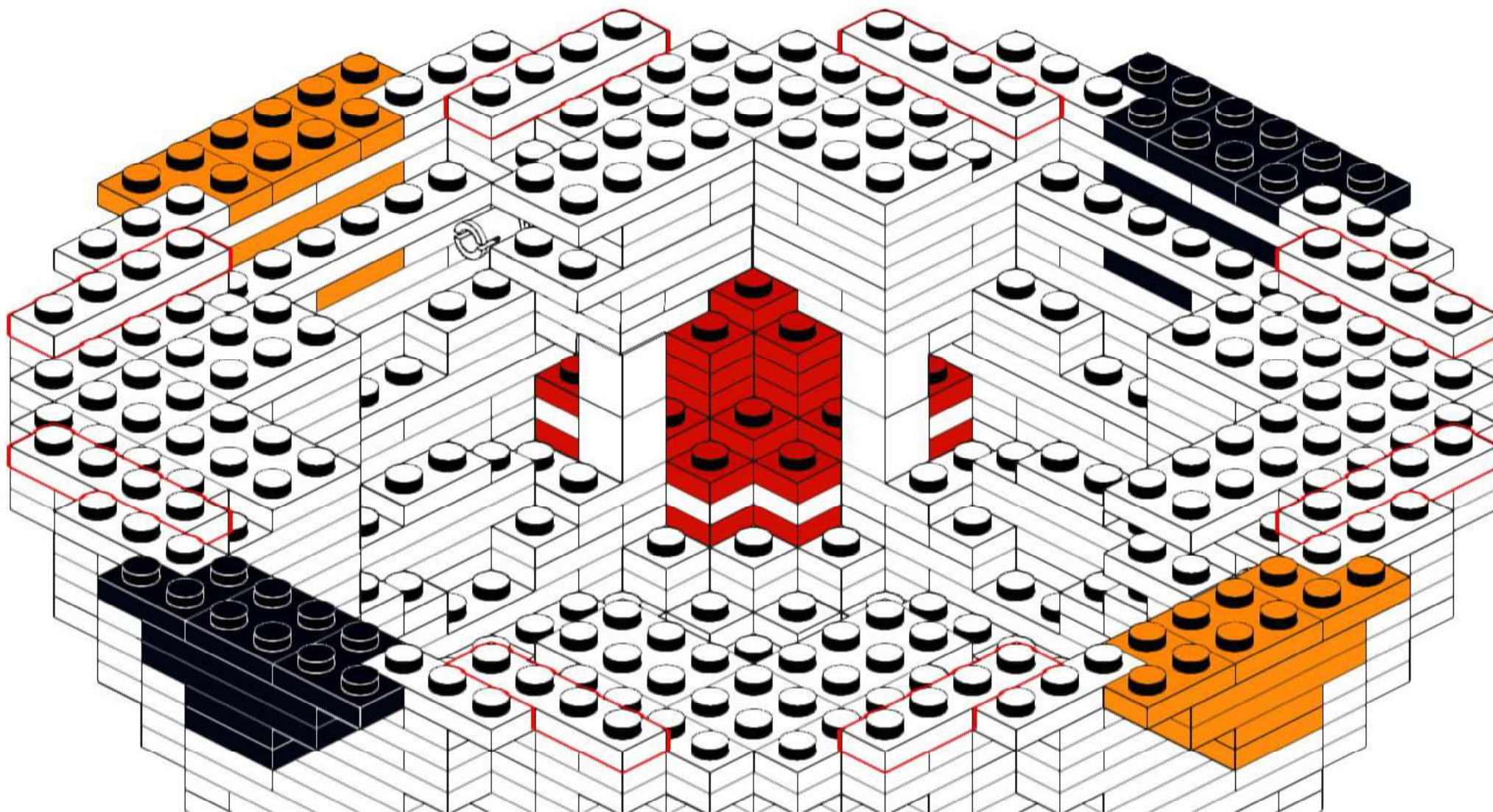
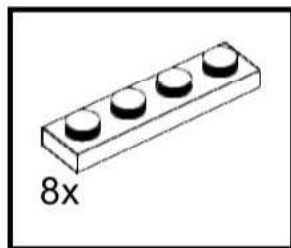

100

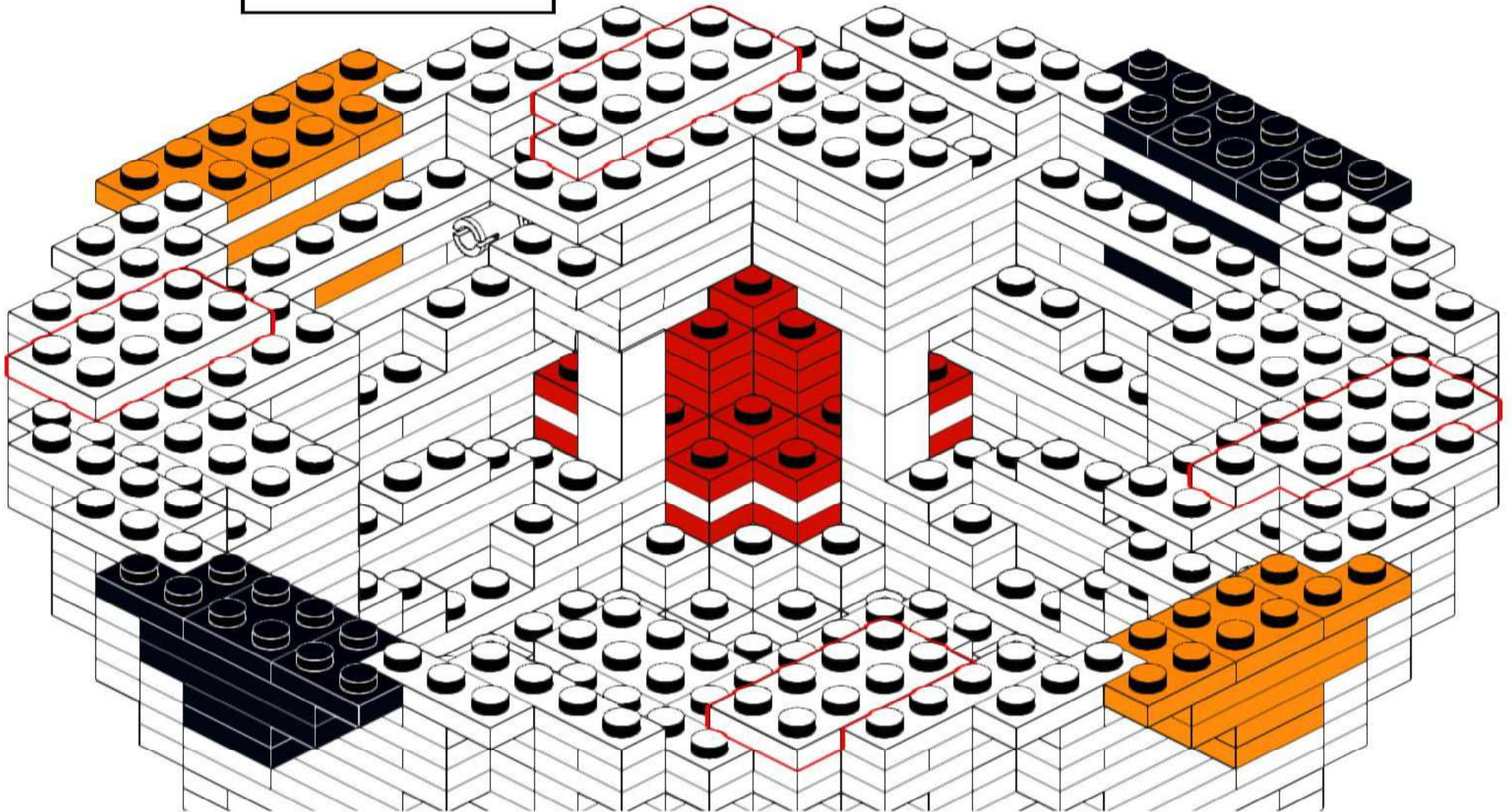
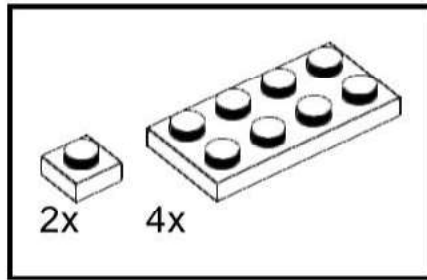

101

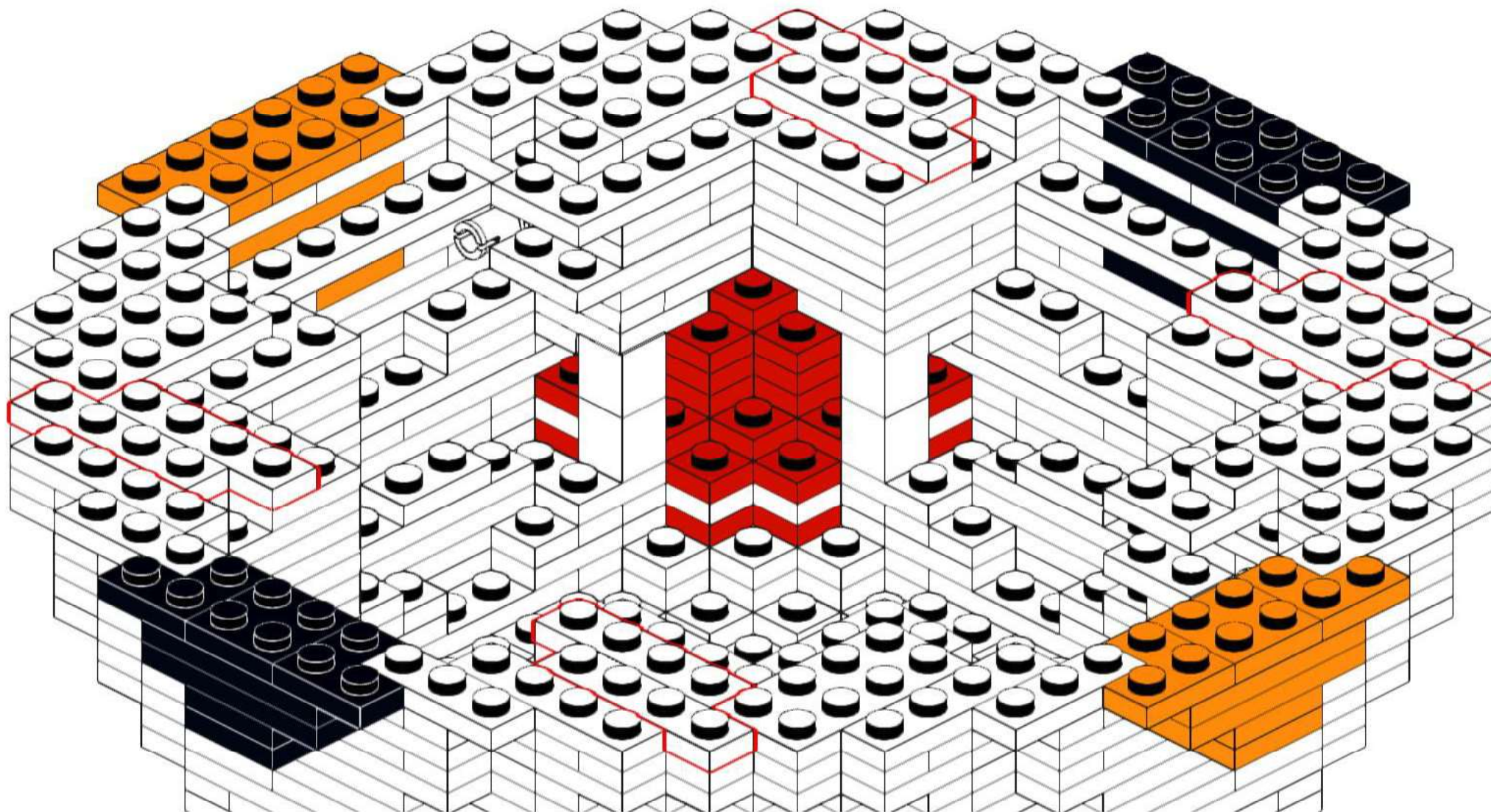
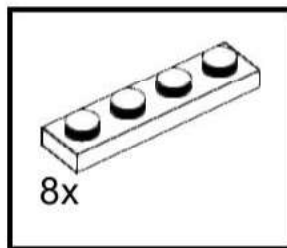

102

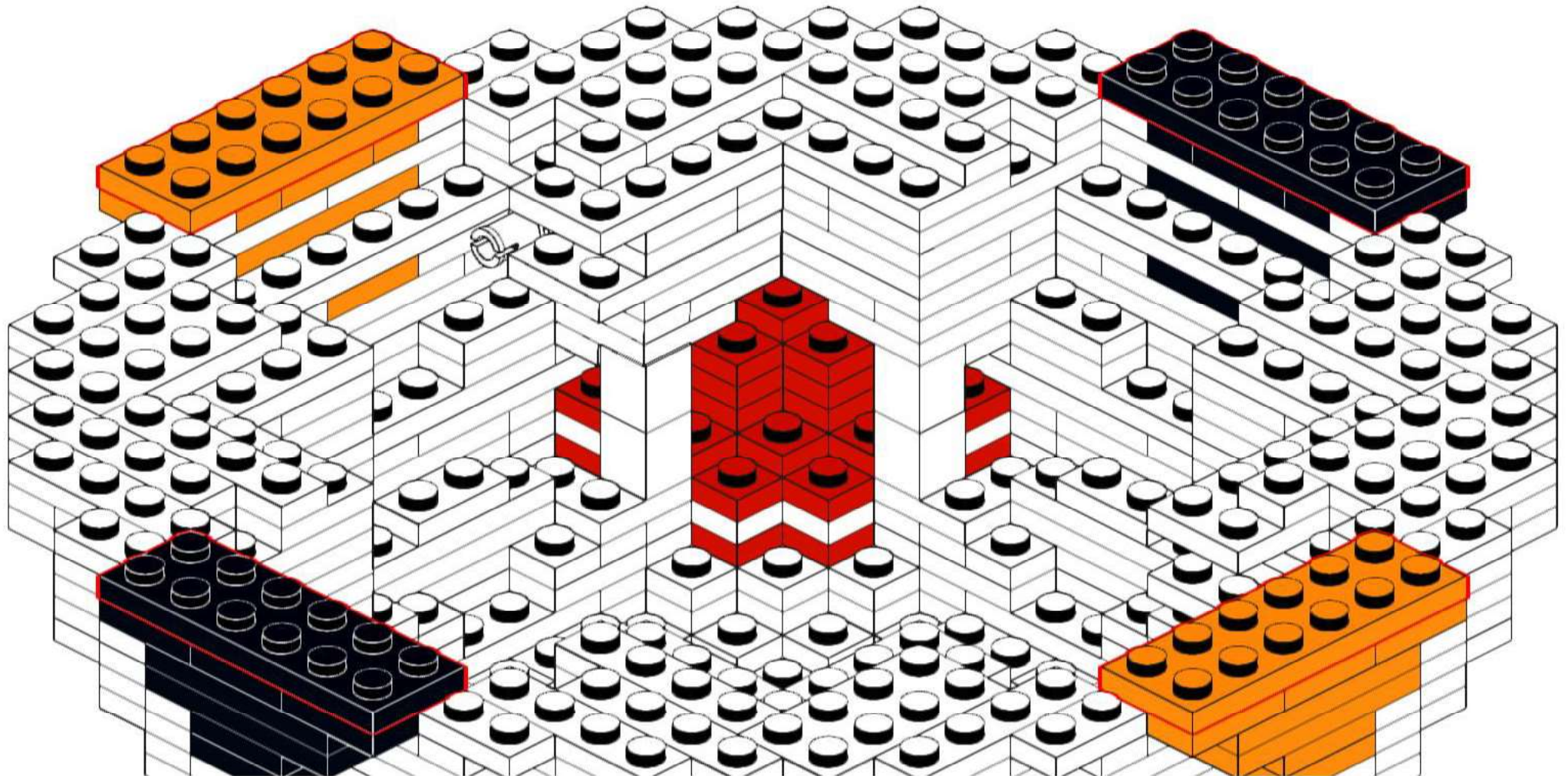
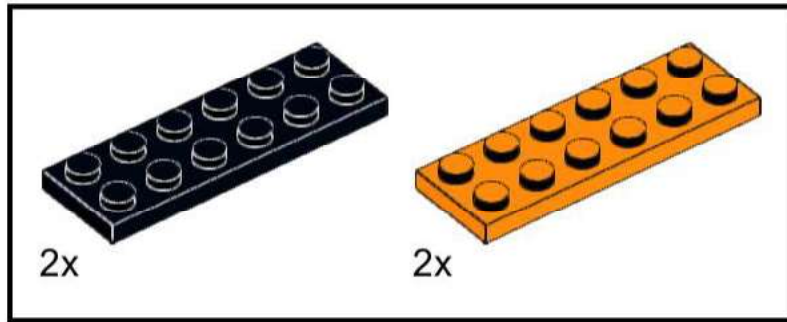

103

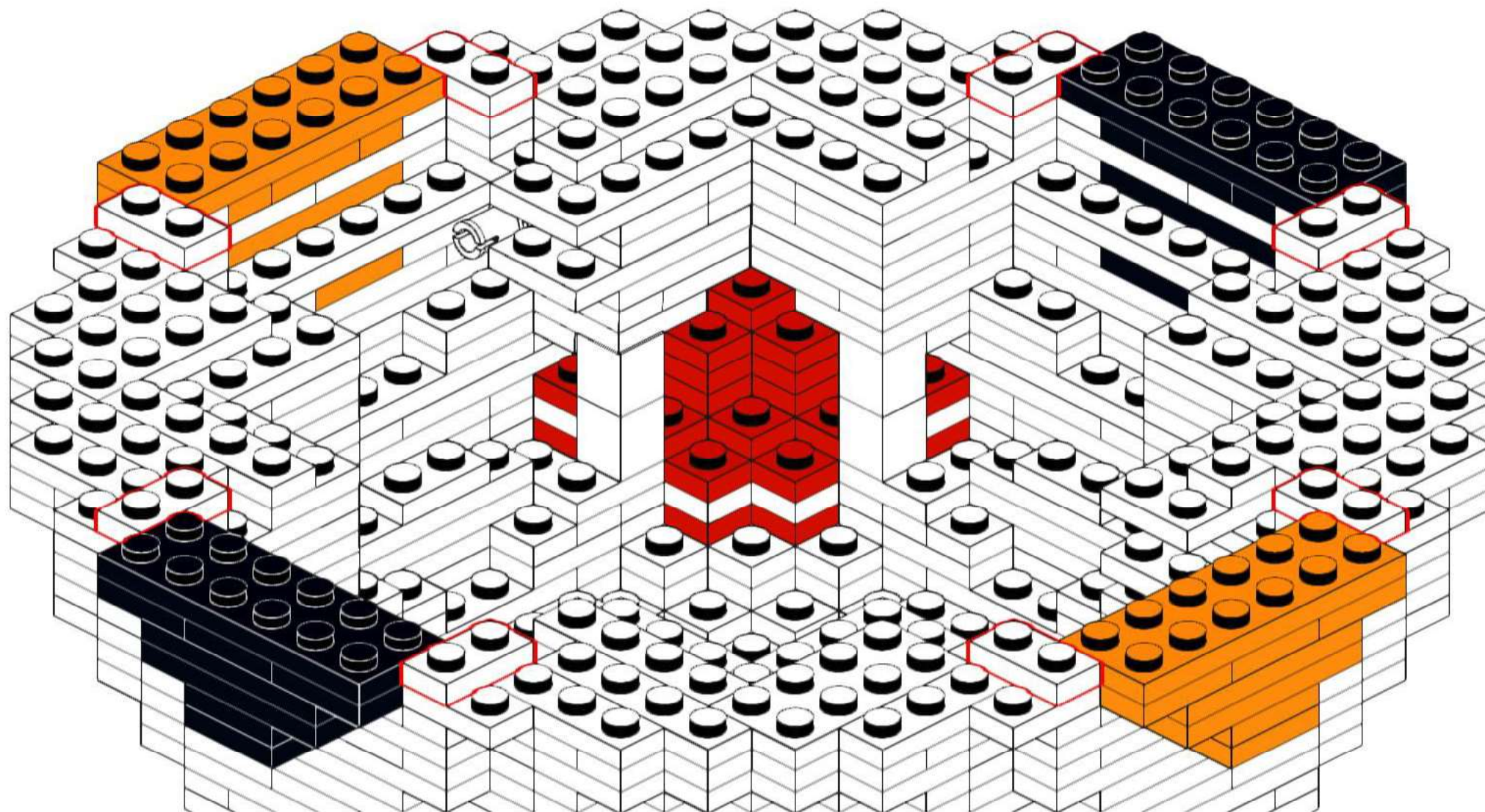
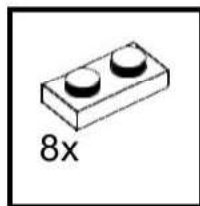

104

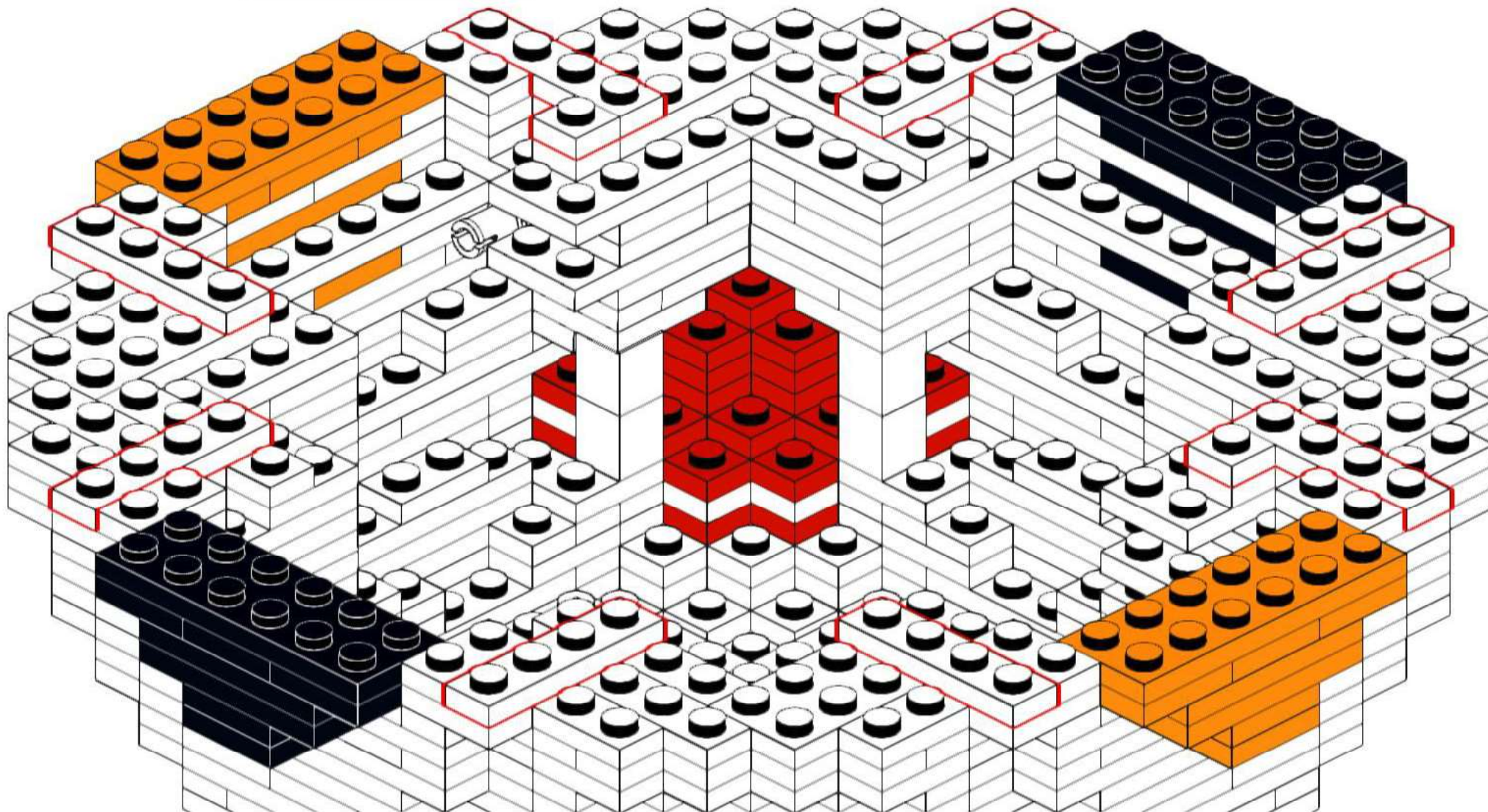
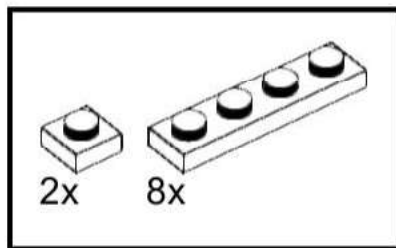

105

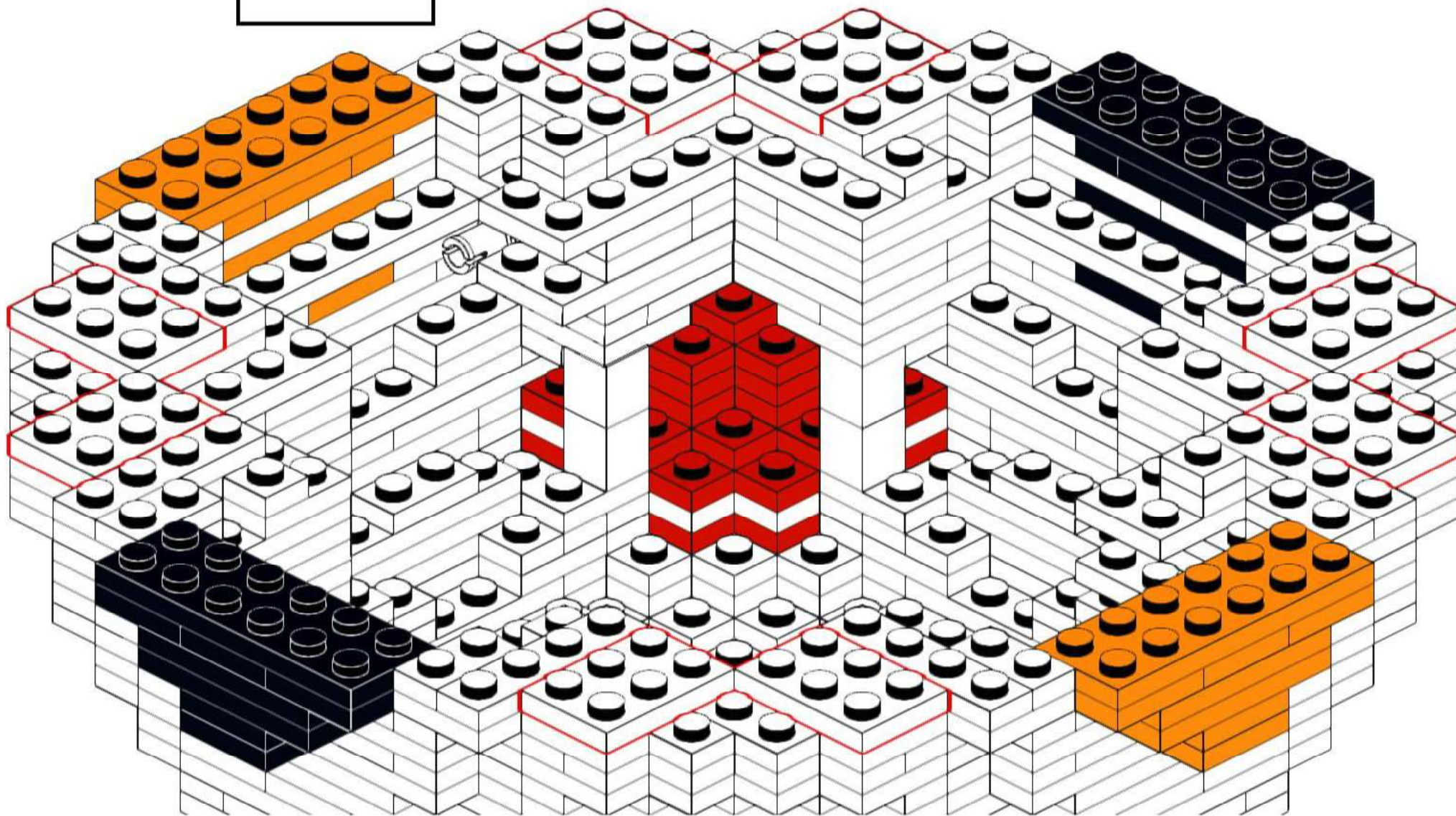
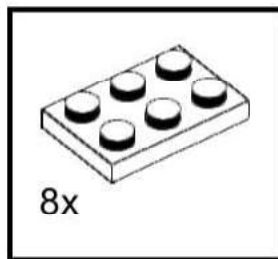

106

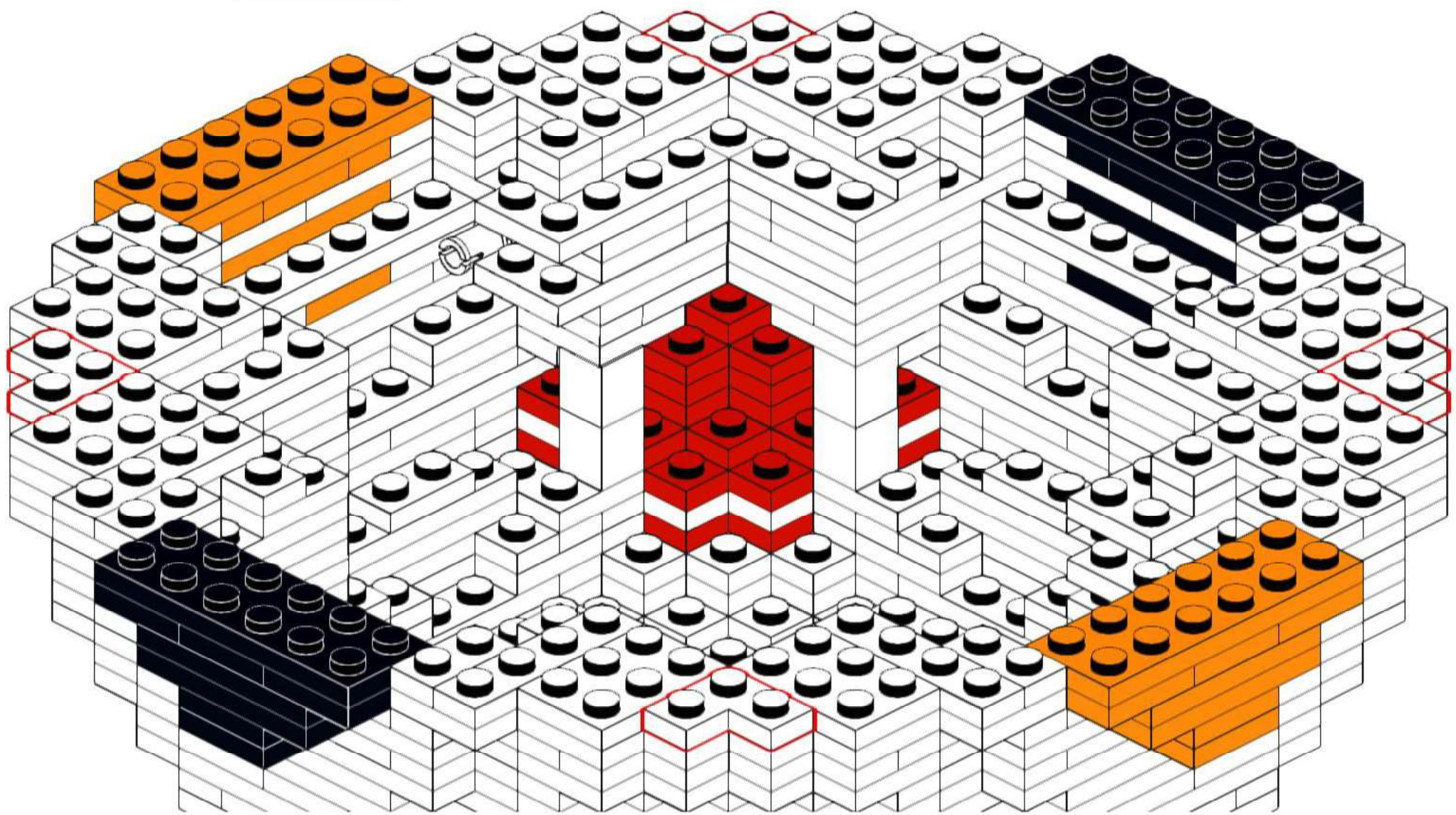
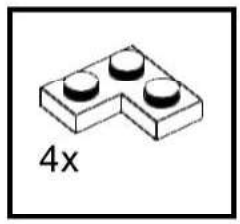

107

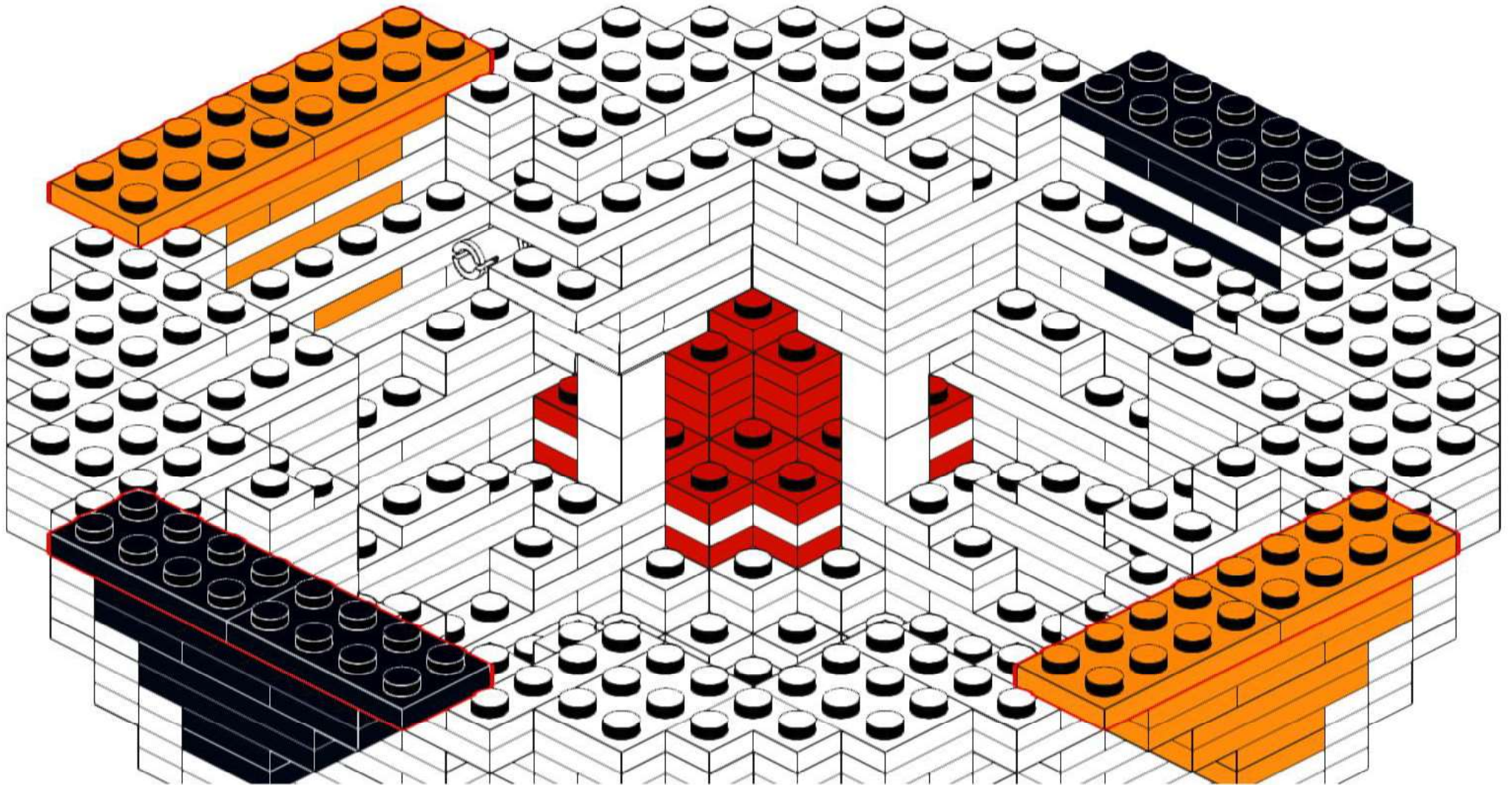
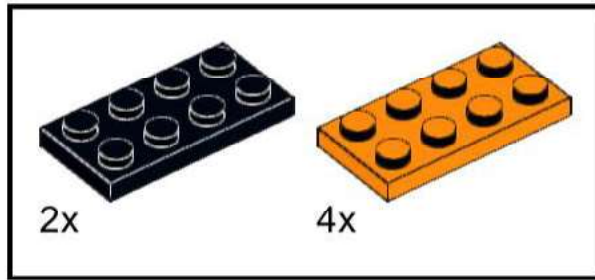

108

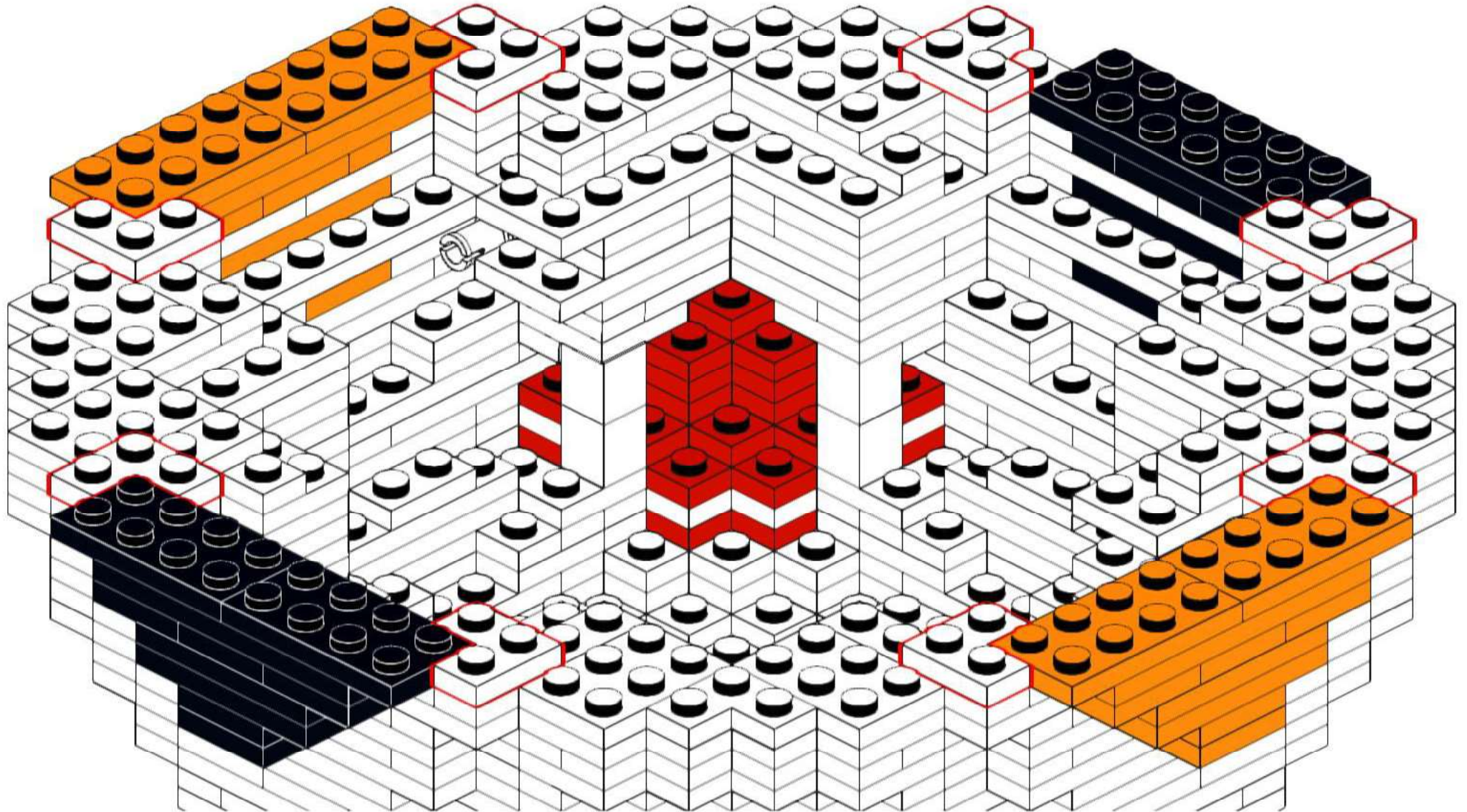
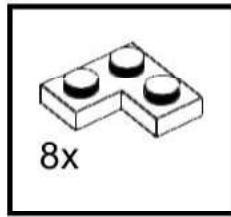

109

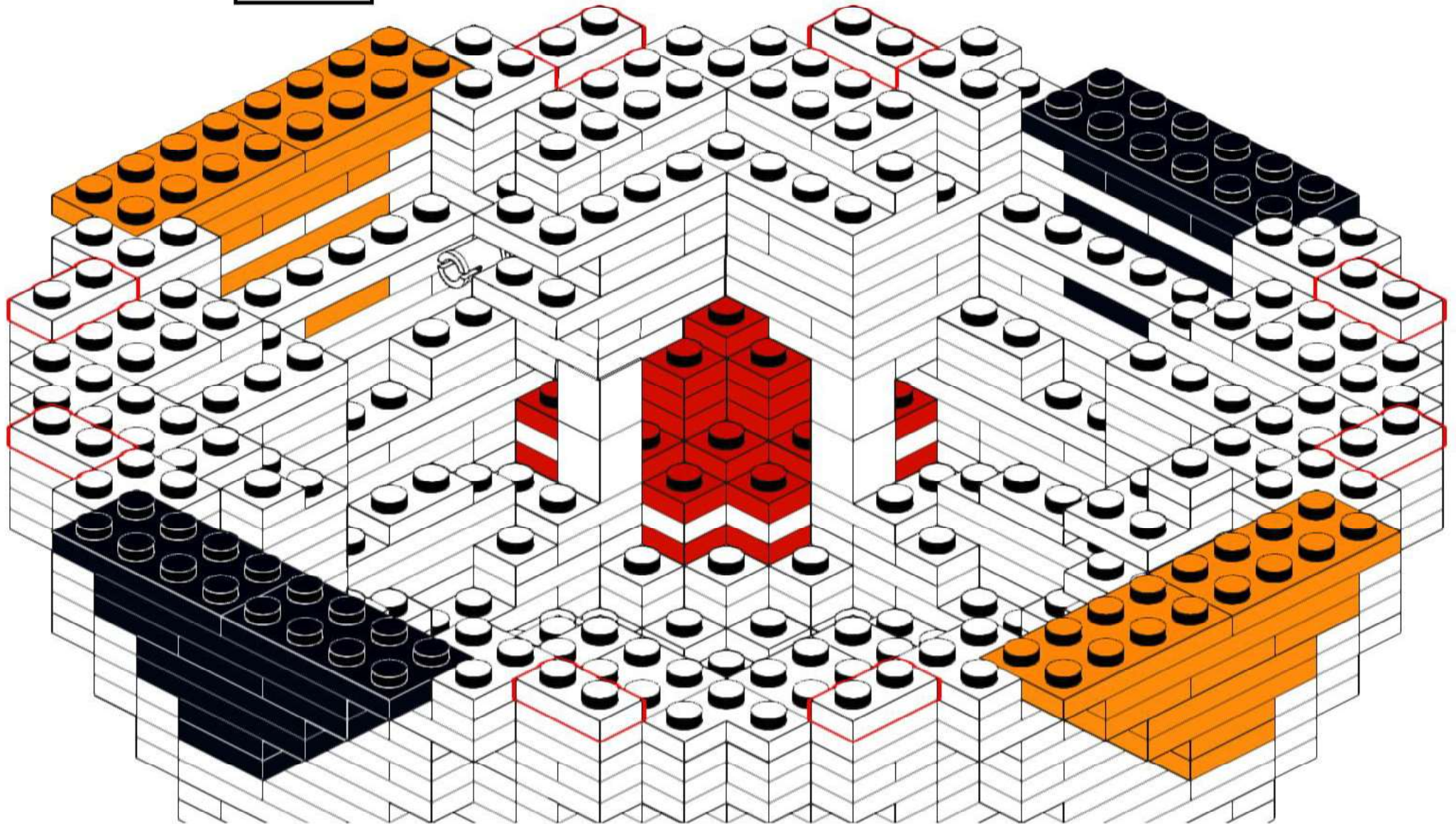
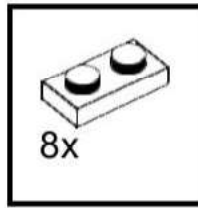

110

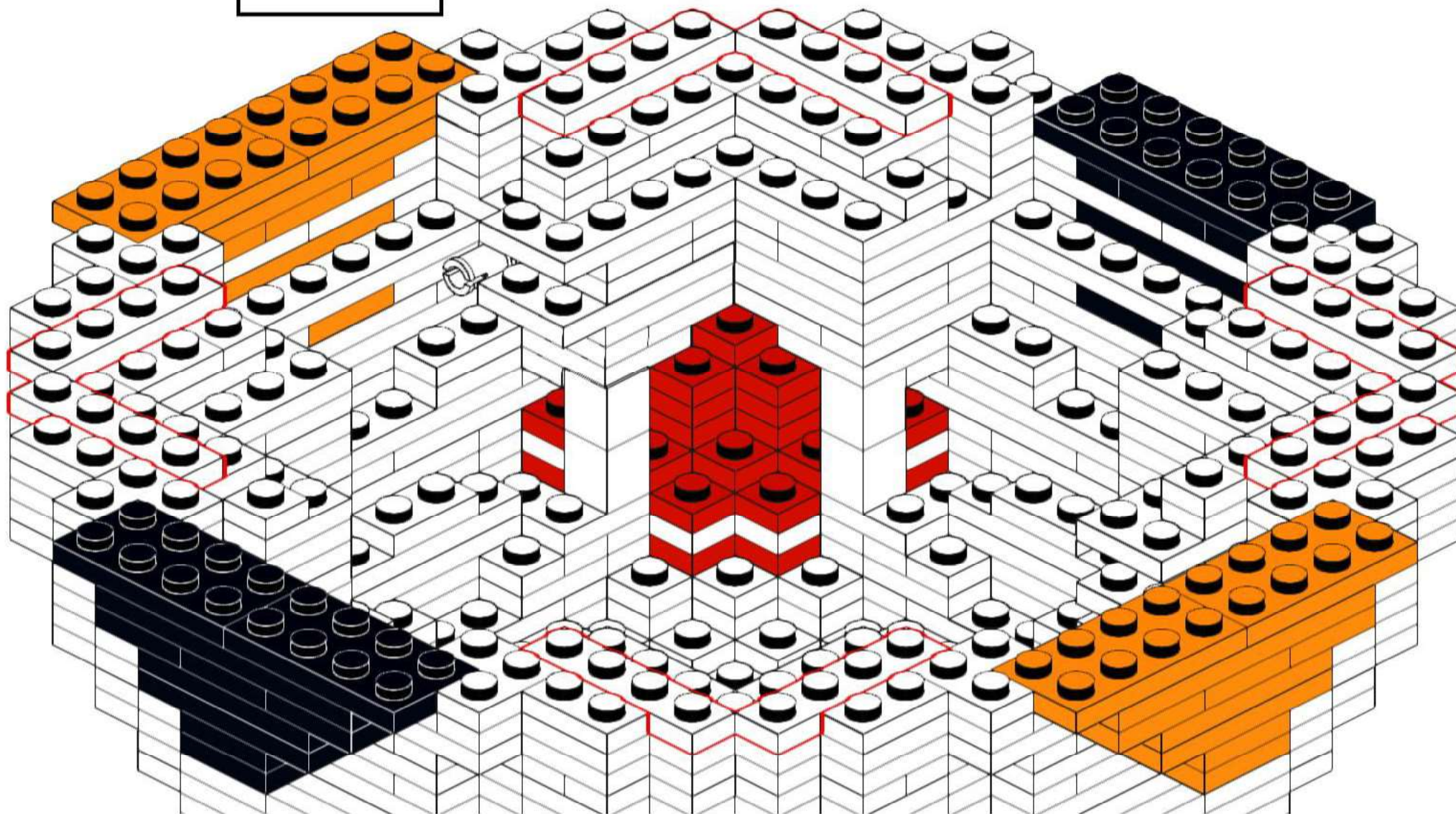
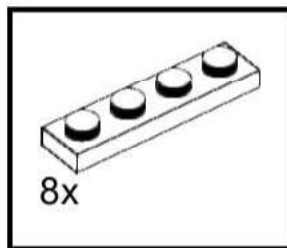

111

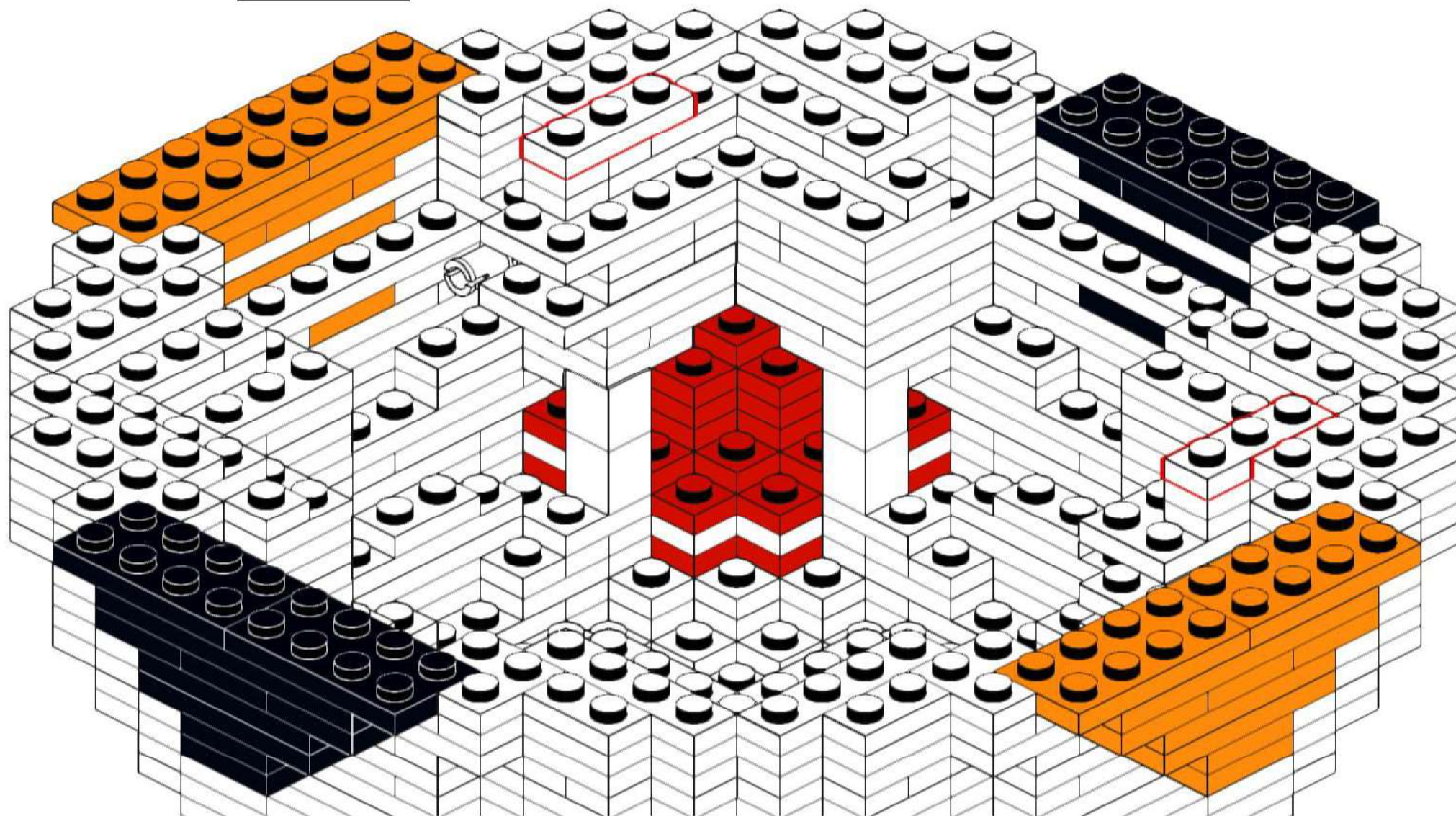
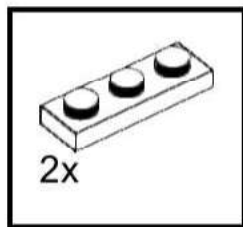

112

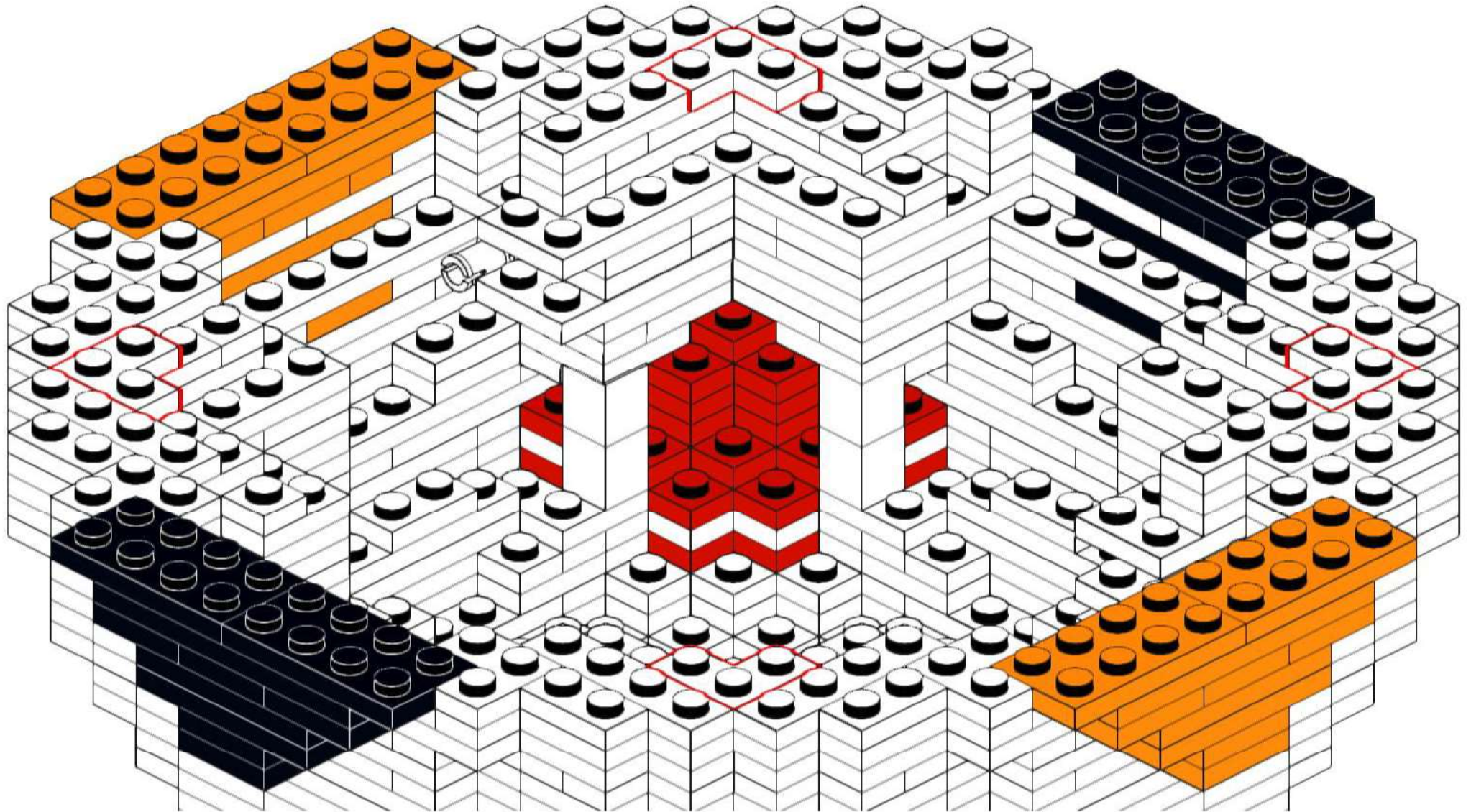
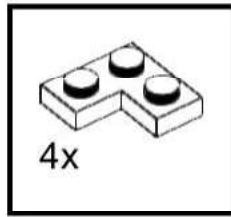

113

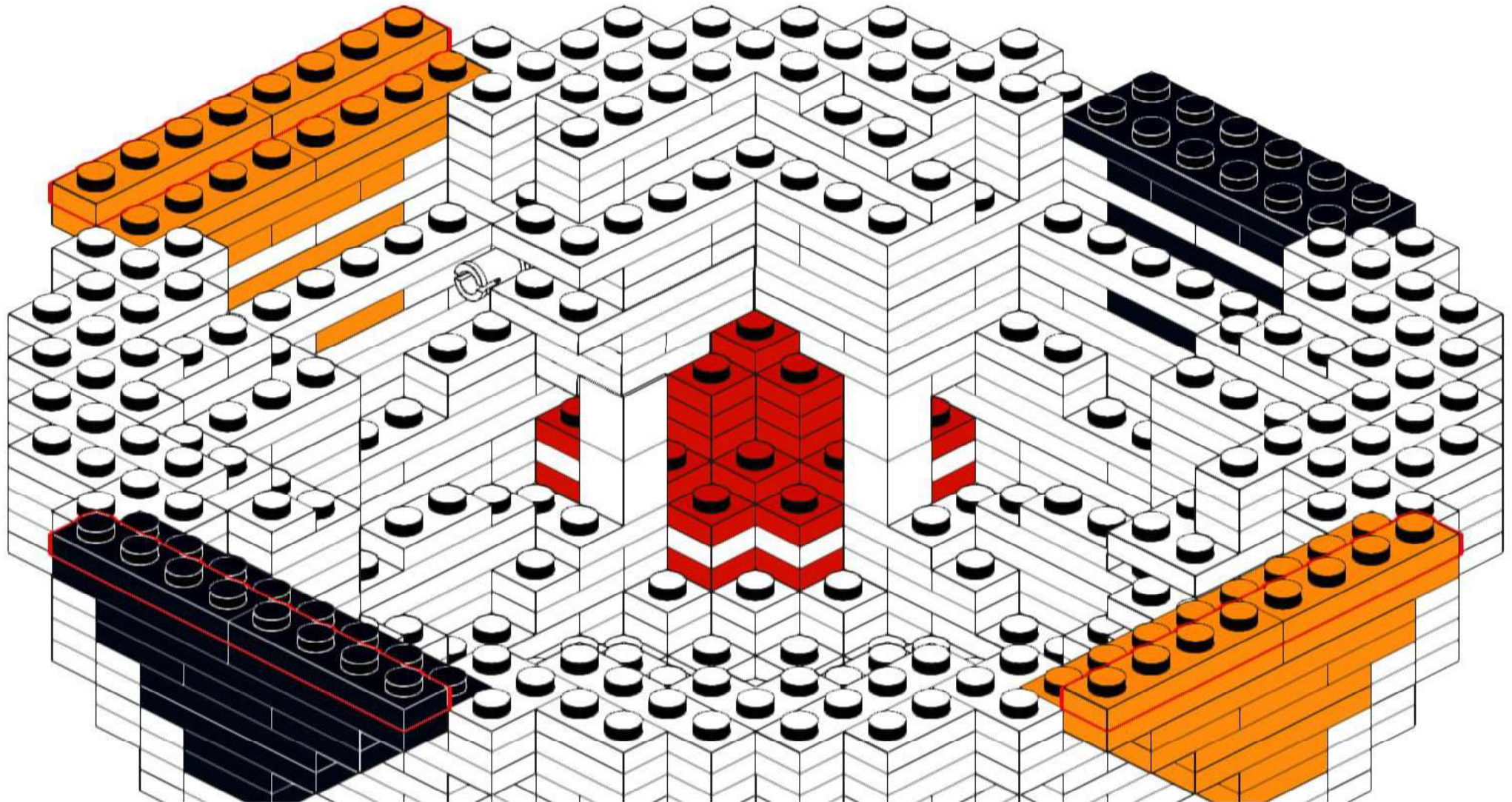
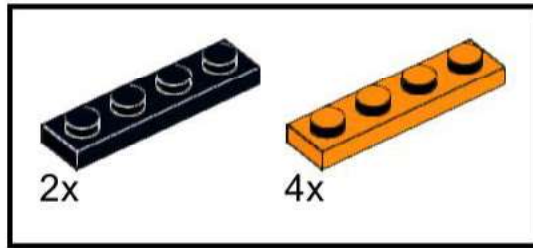

114

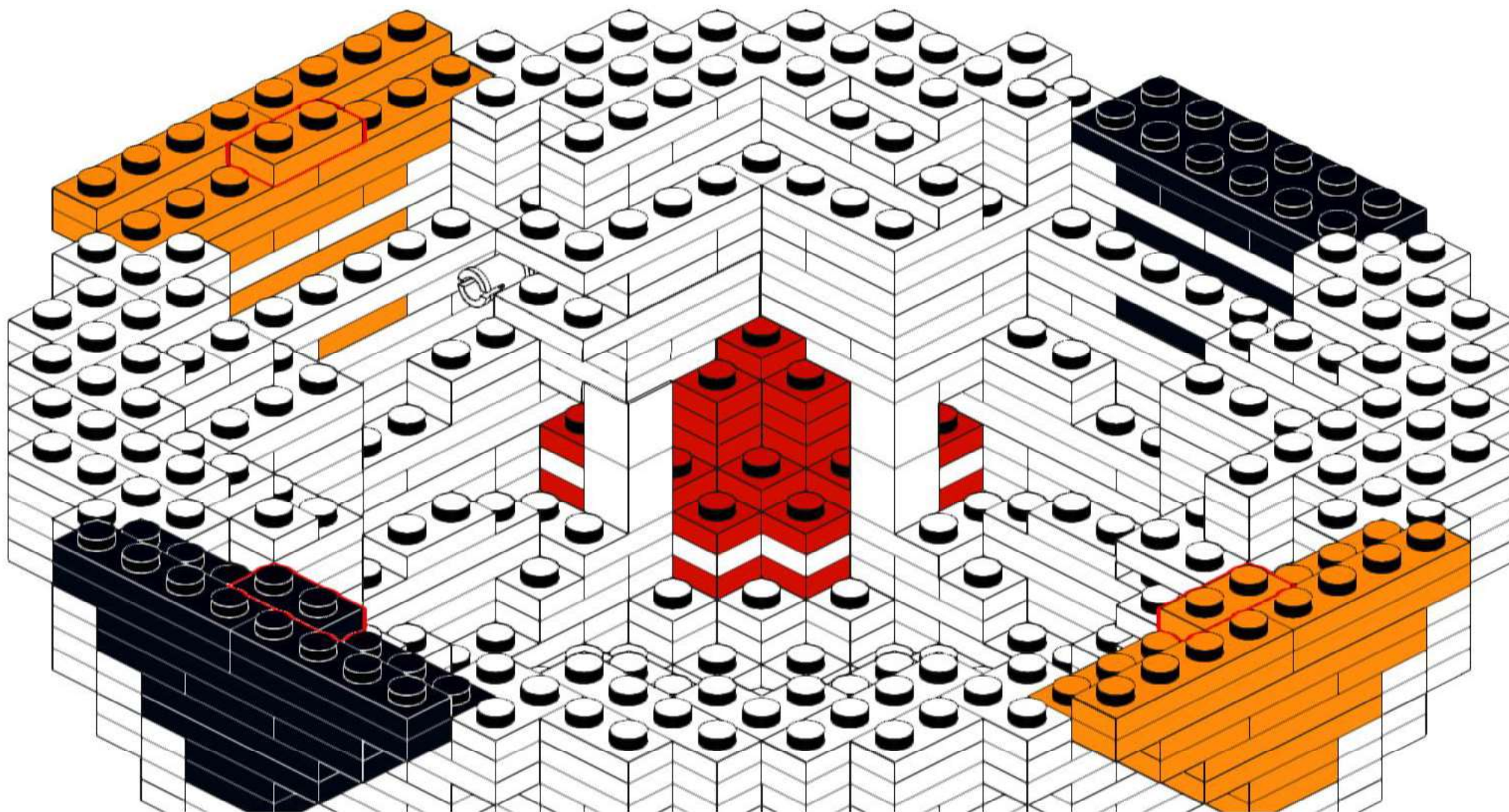
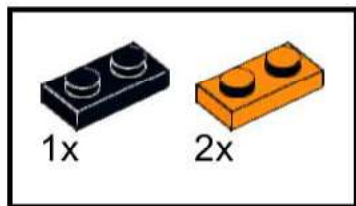

115

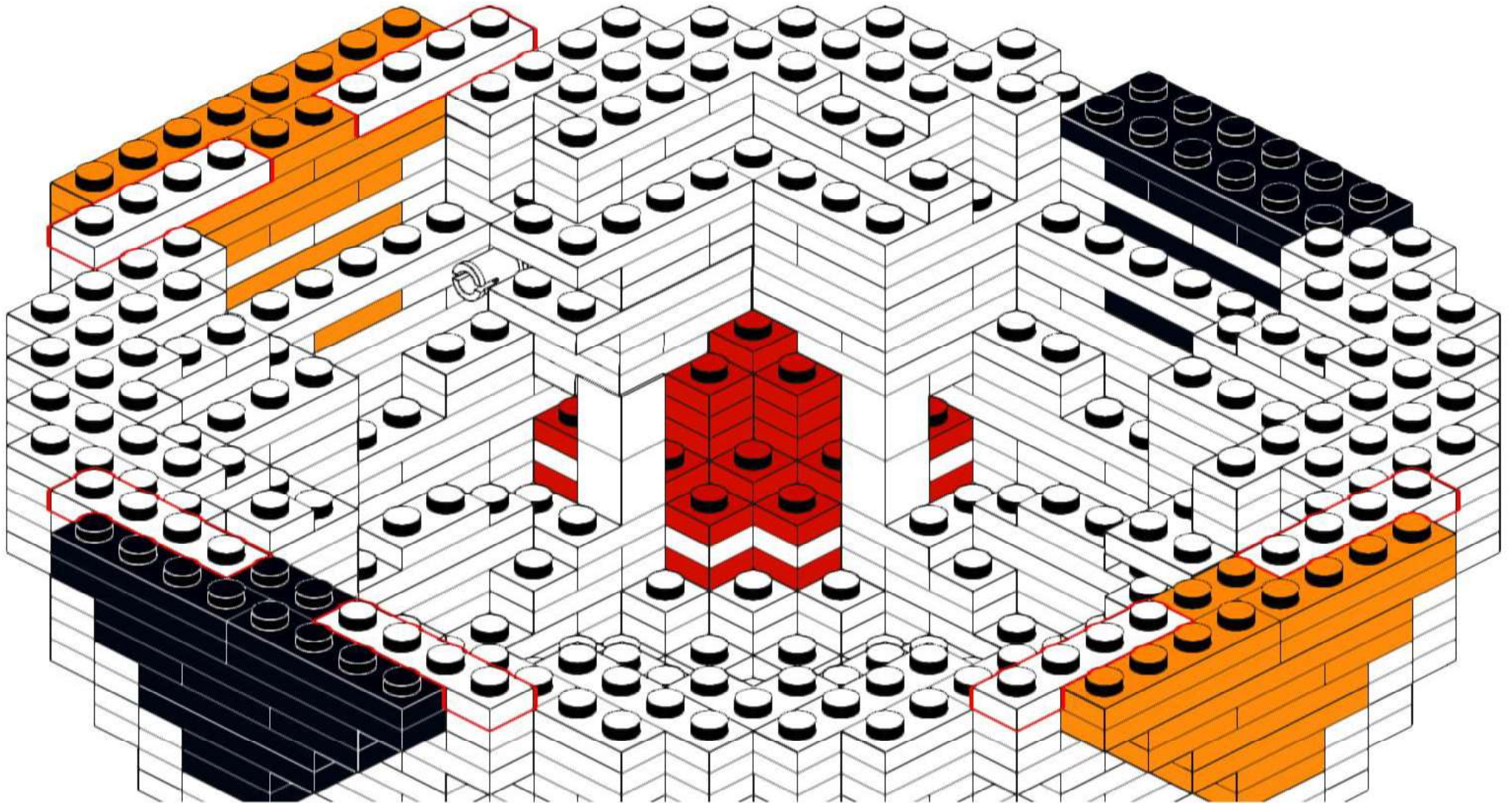
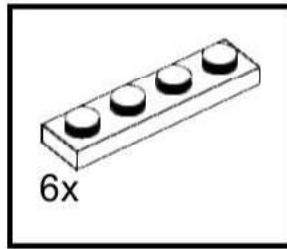

116

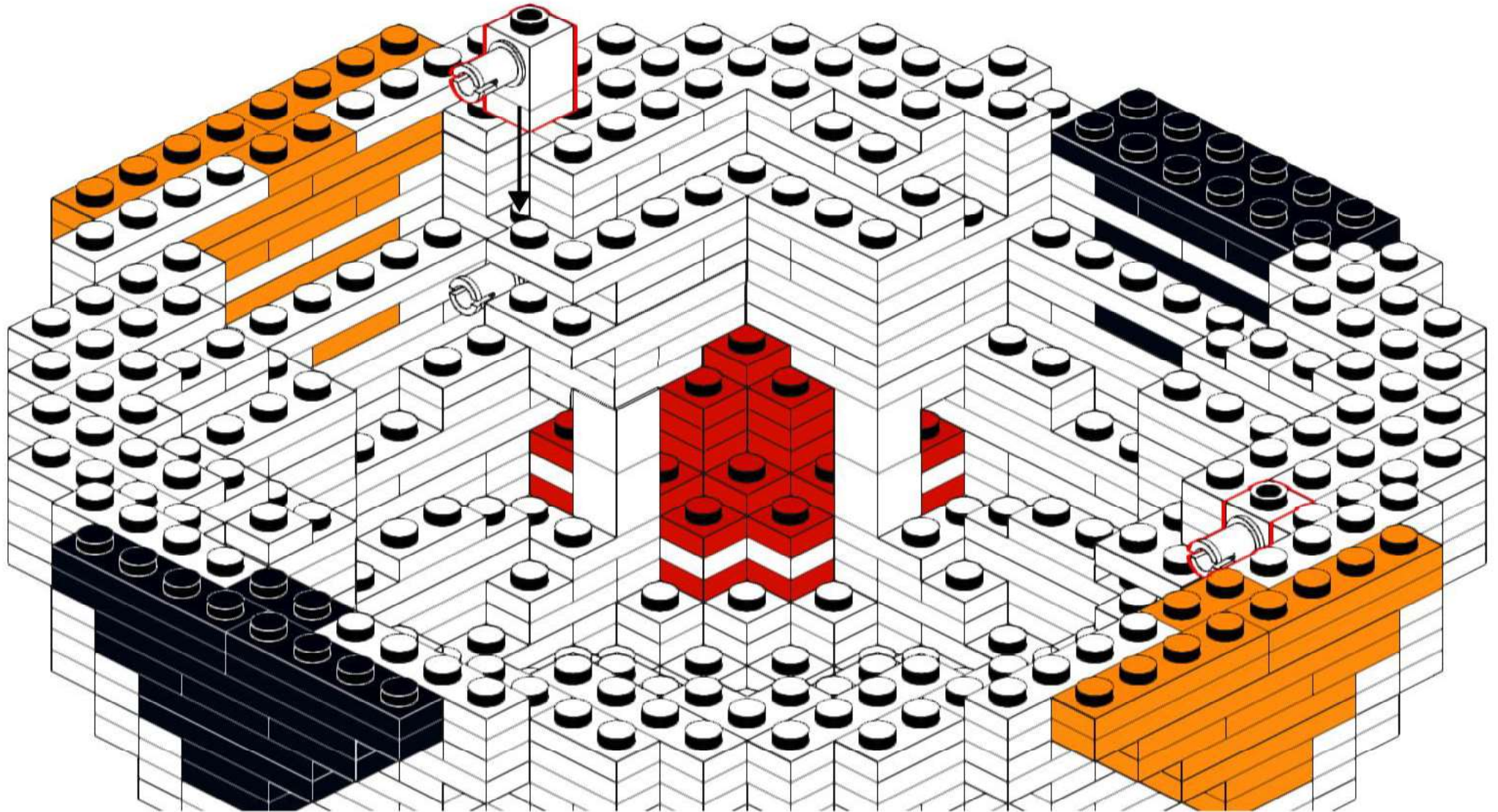
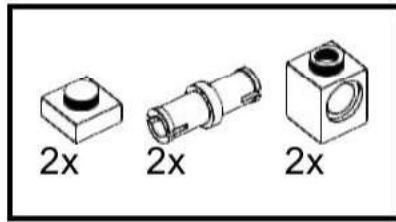

117

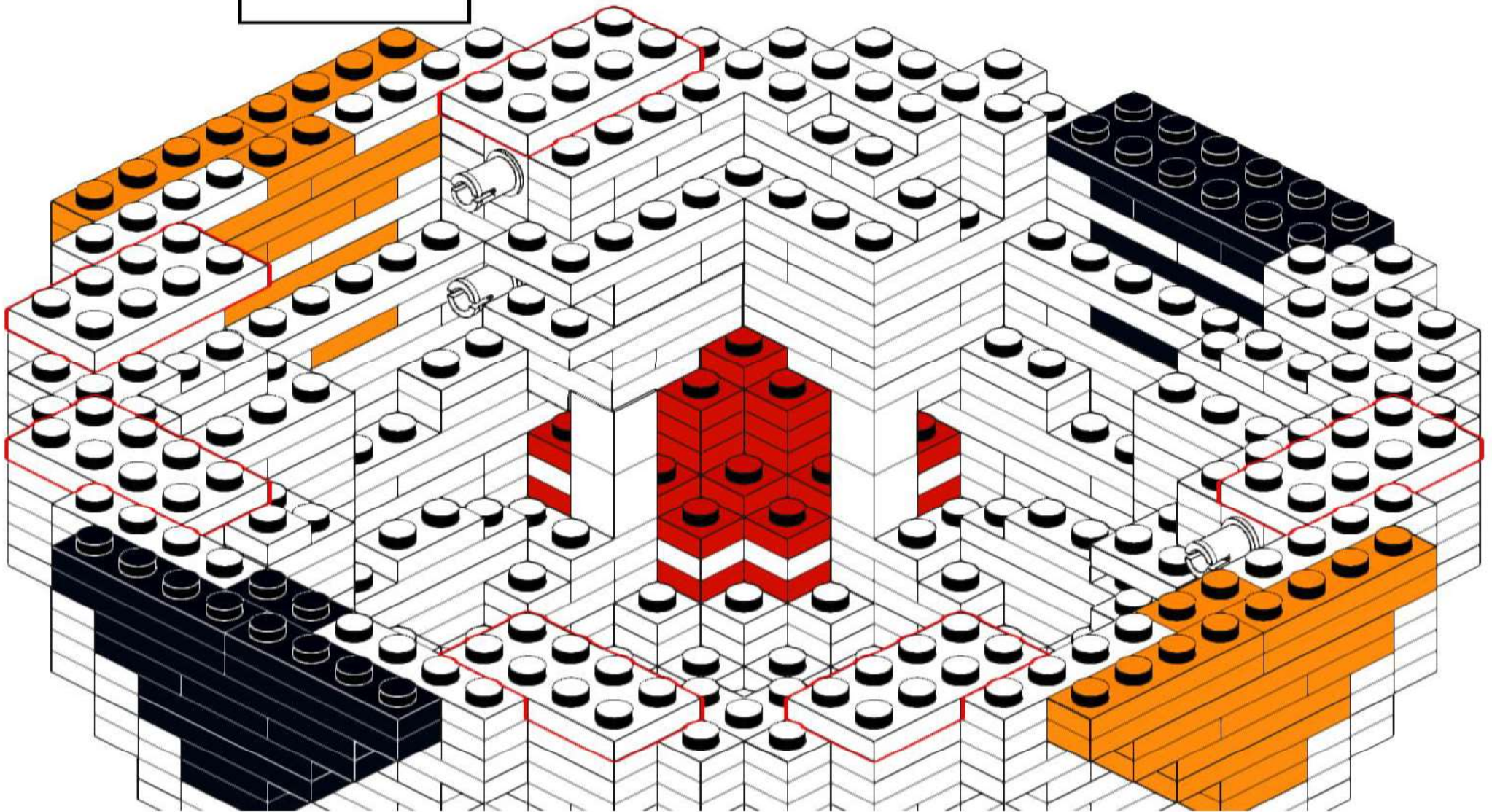
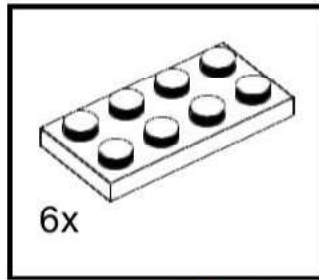

118

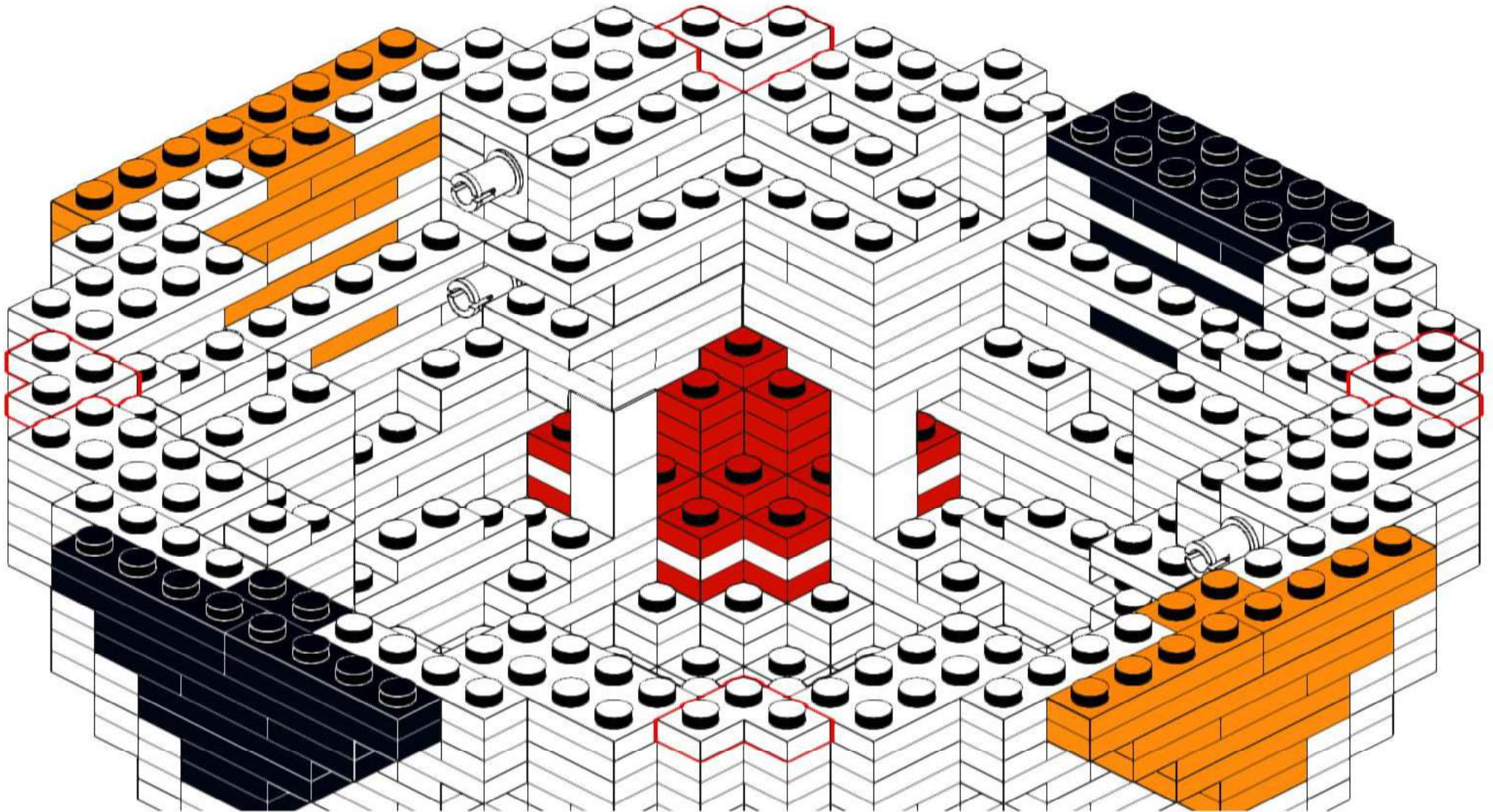
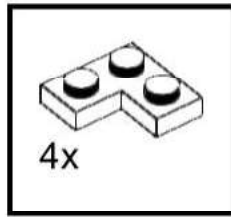

119

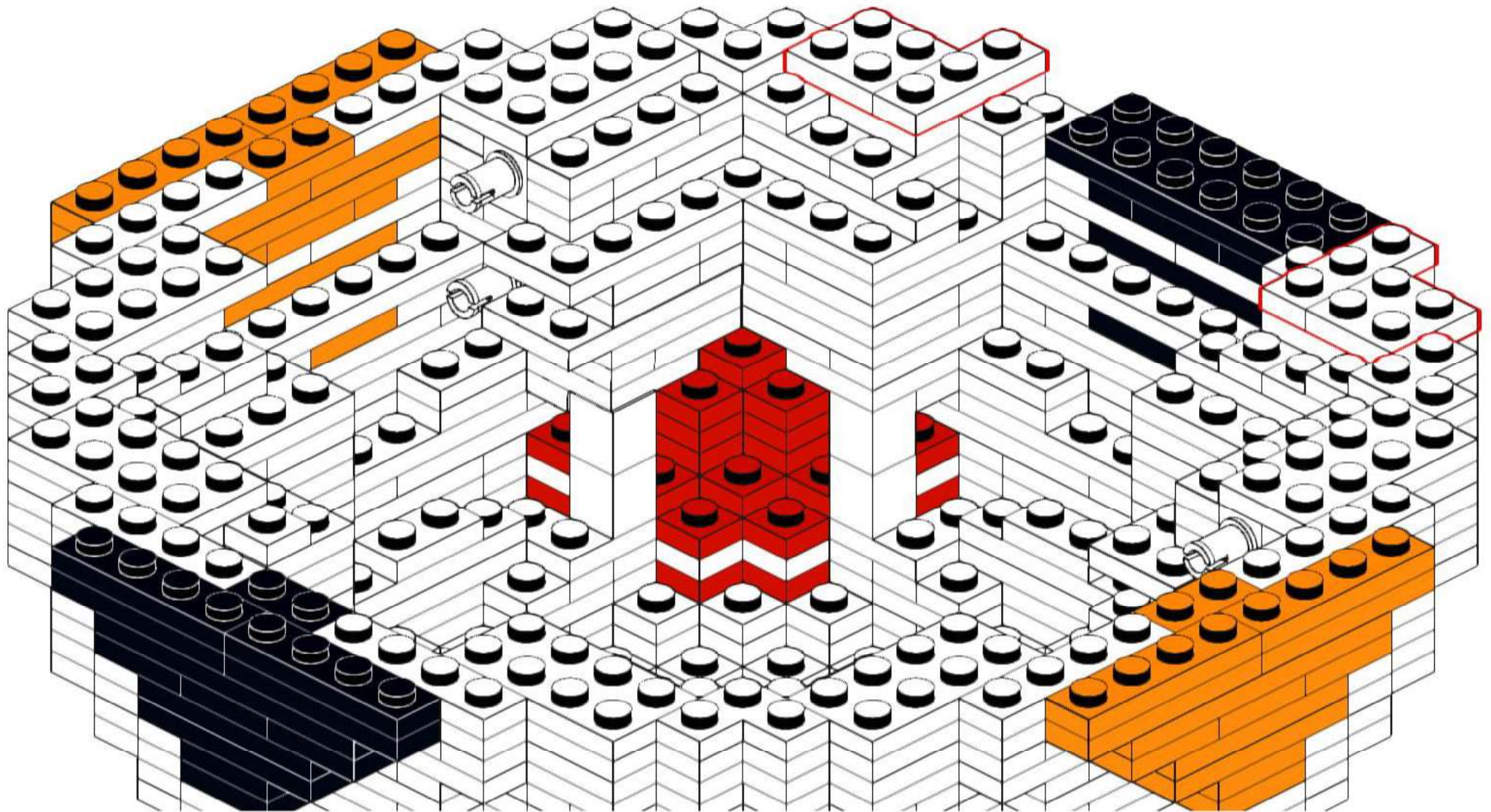
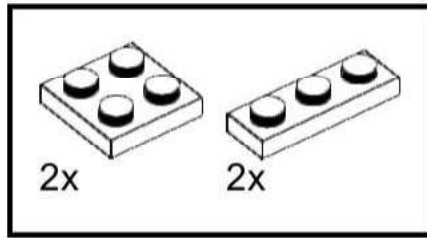

120

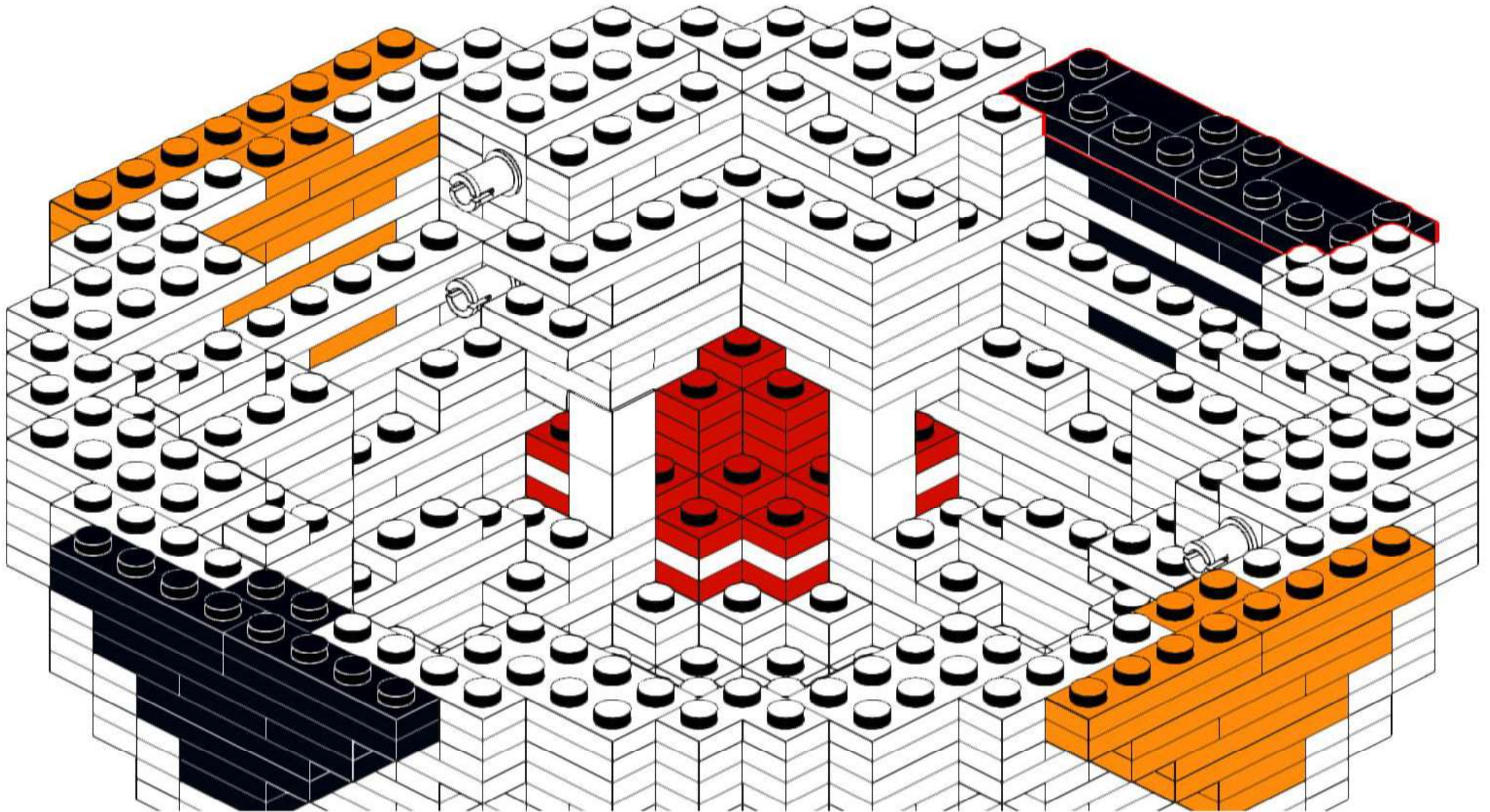
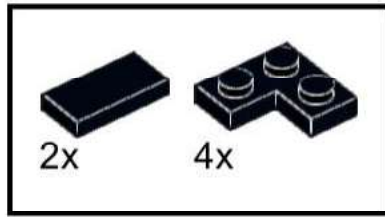

121

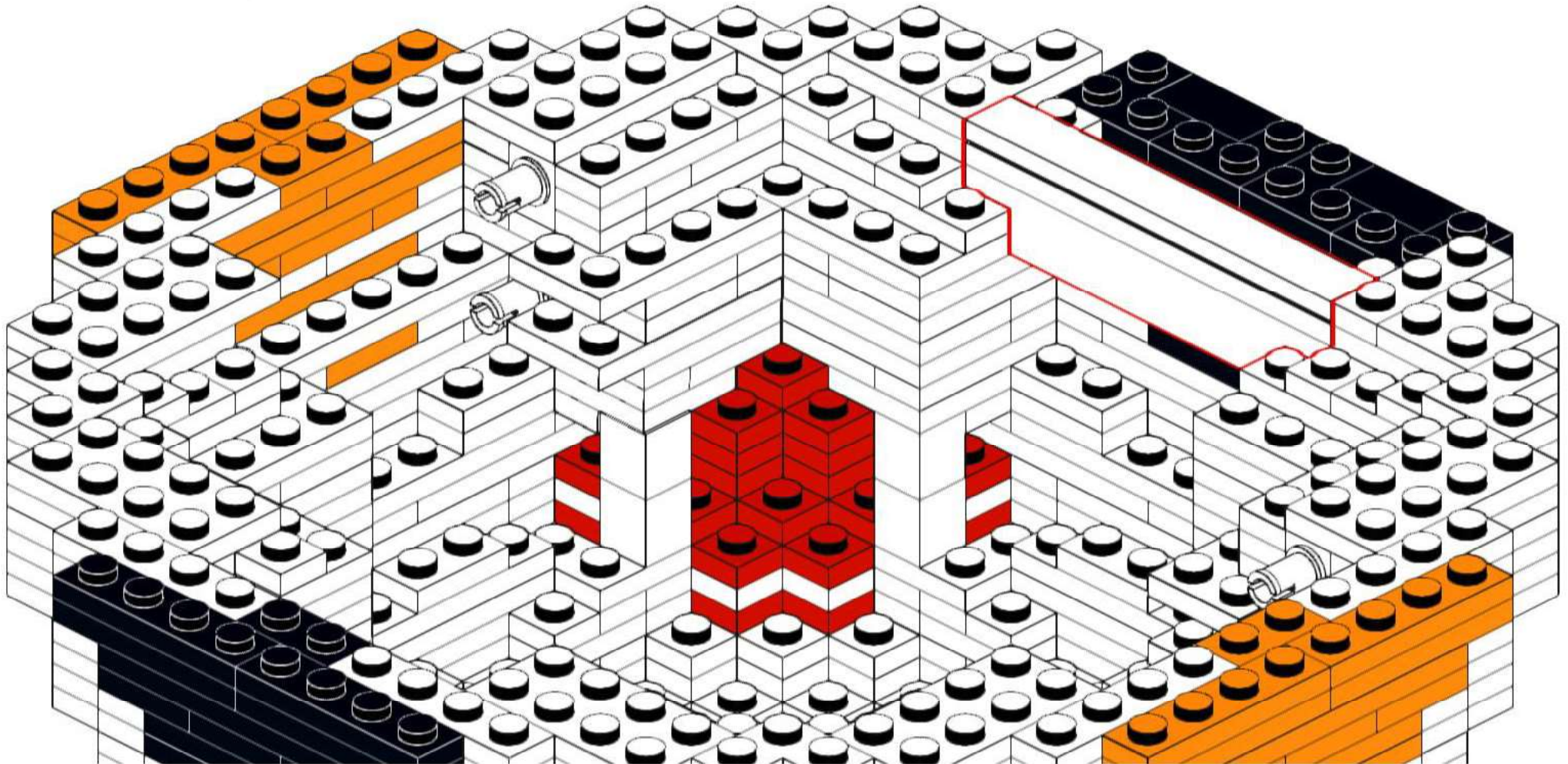
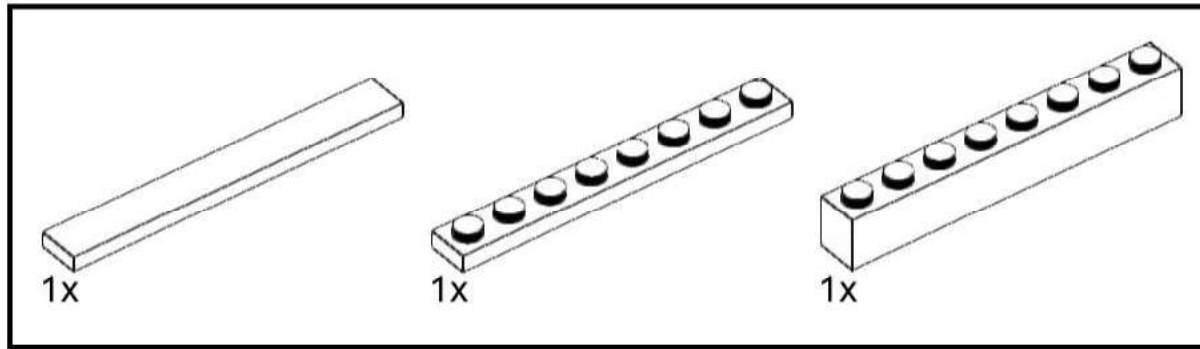

122

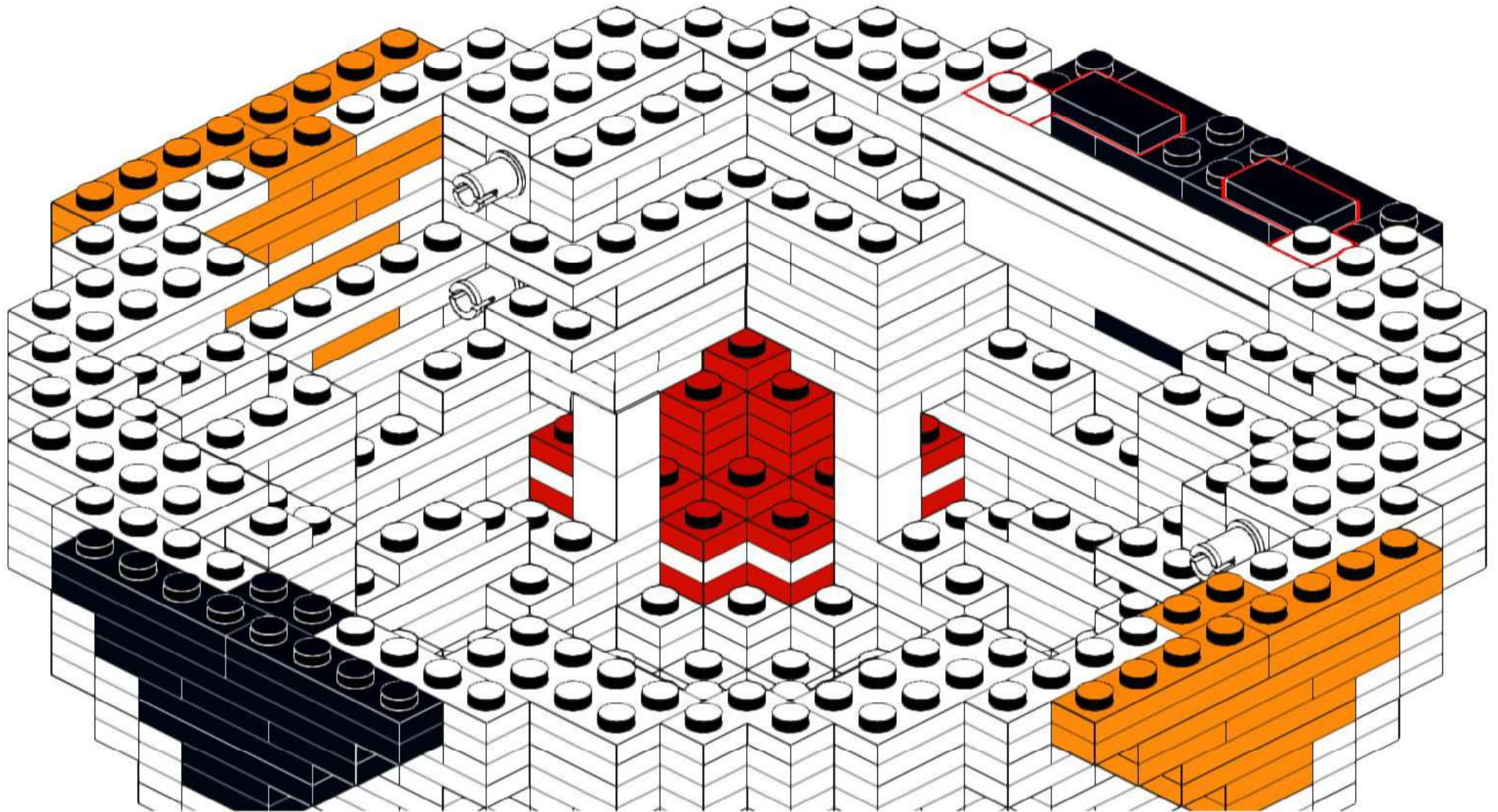
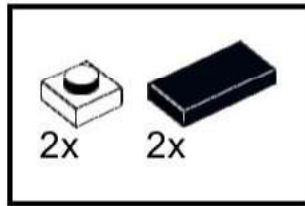

123

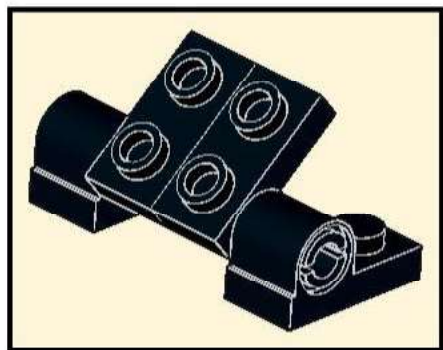

2x

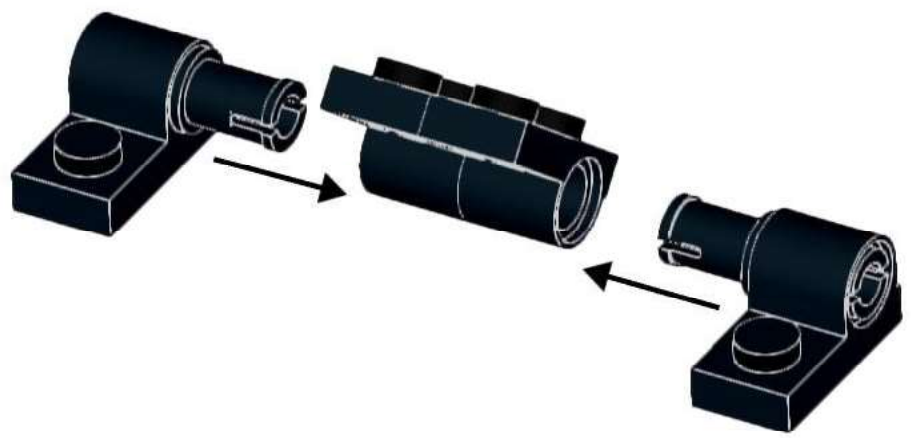
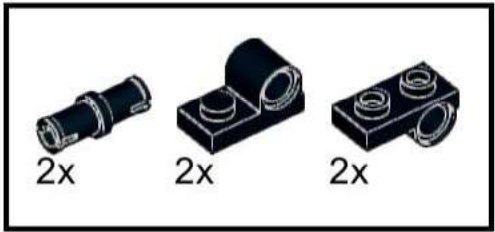

124

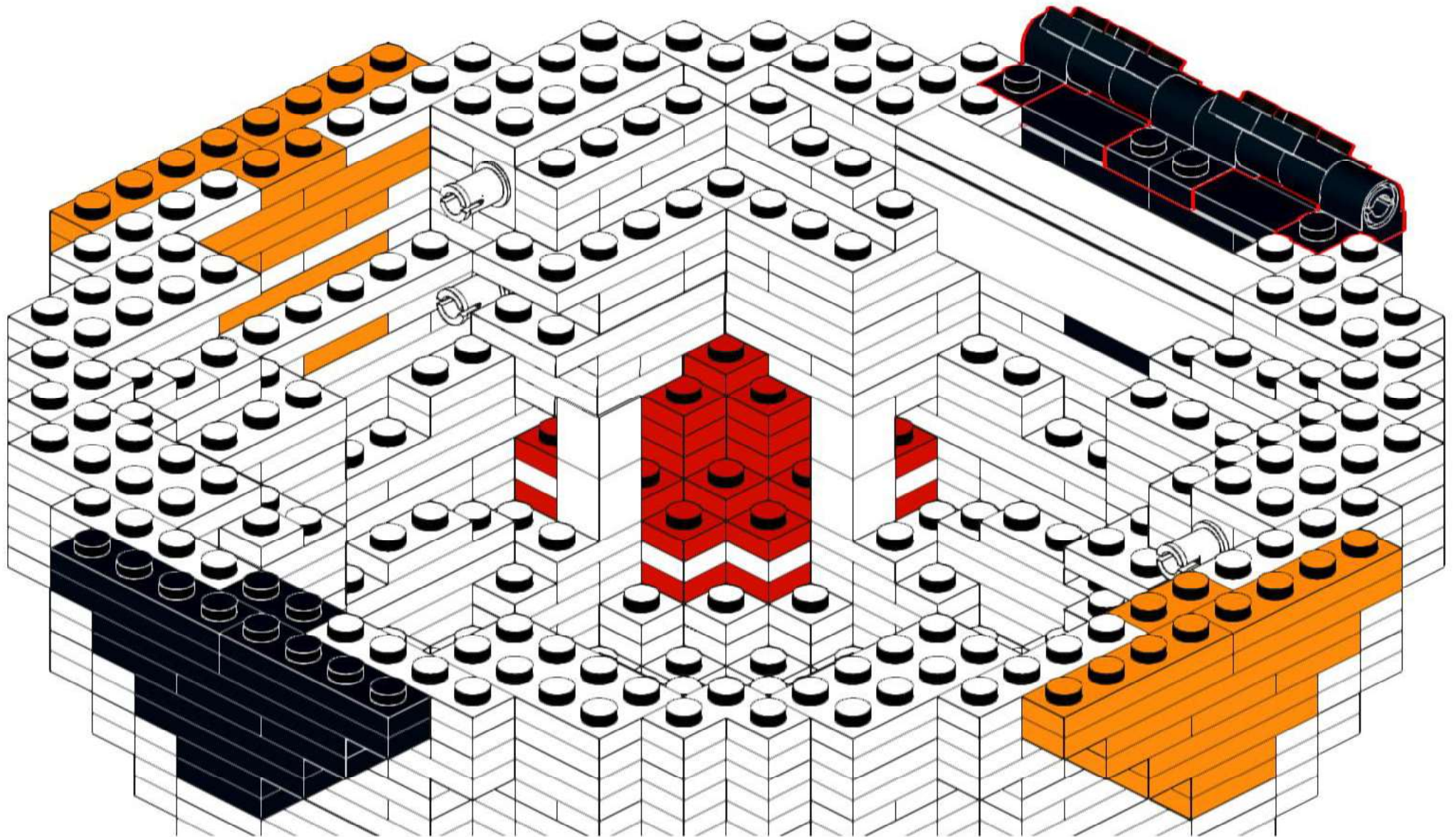

125

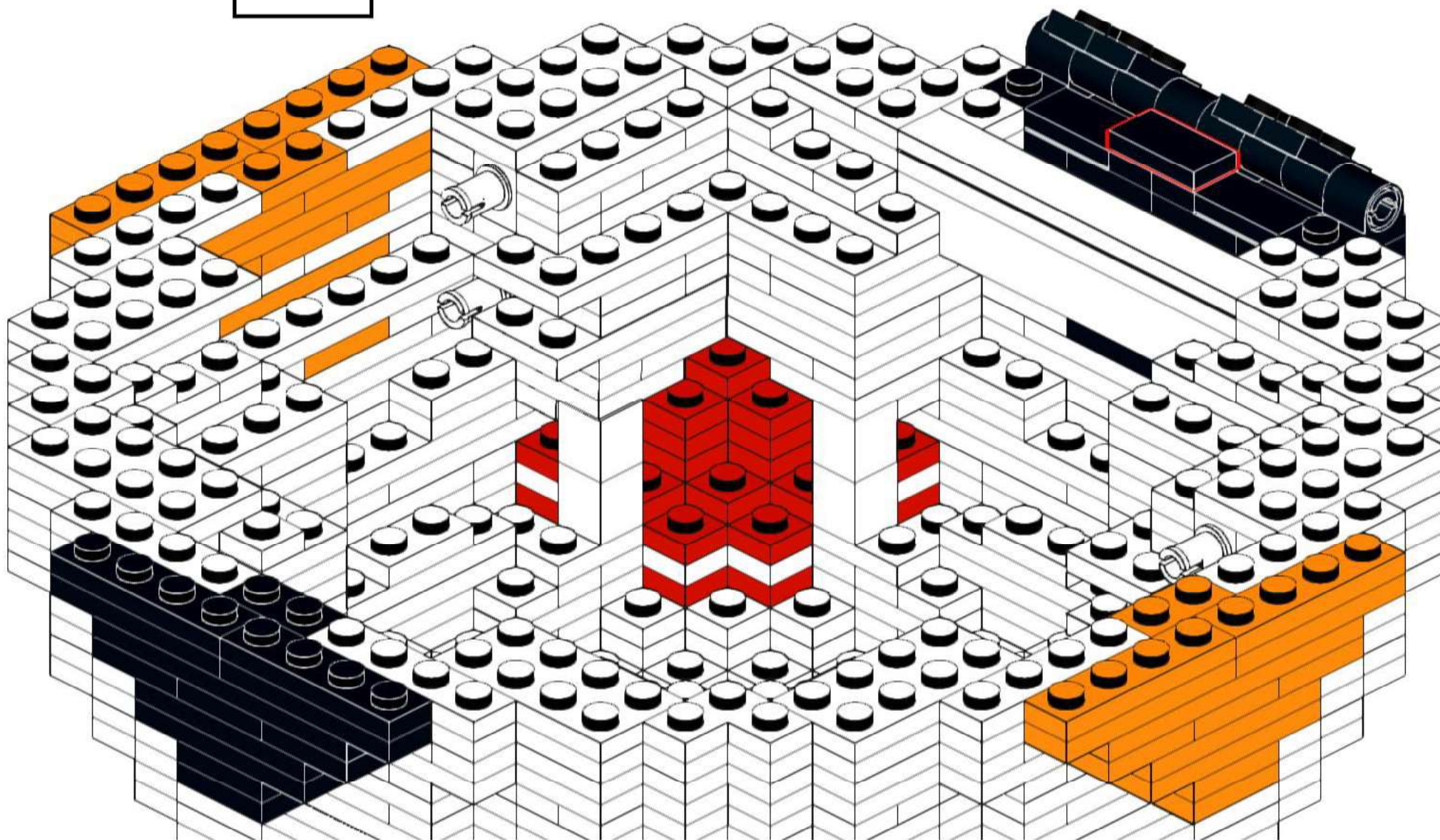
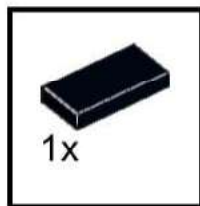

126

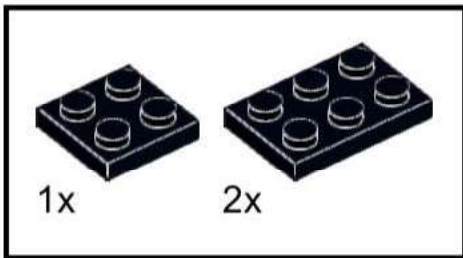
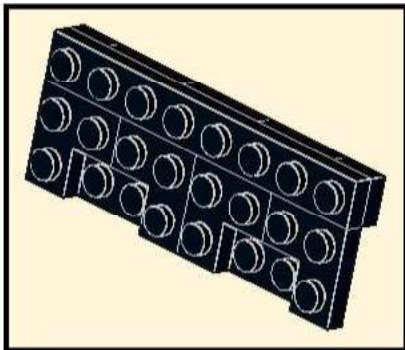

127

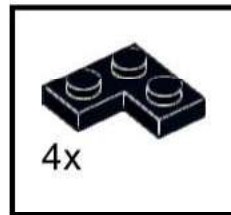

128

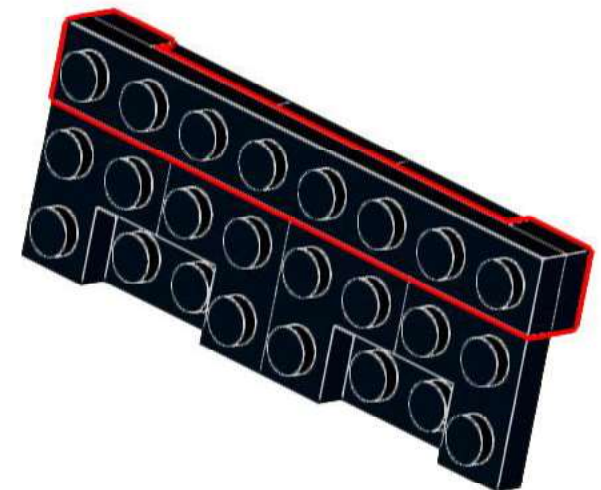
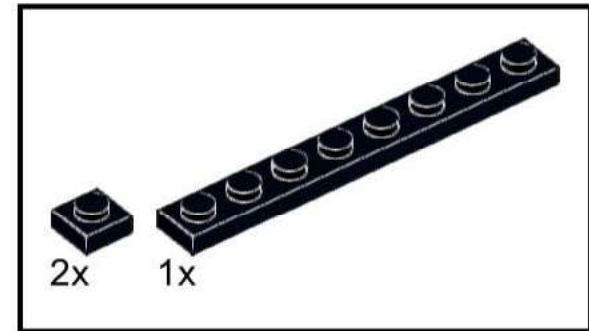

129

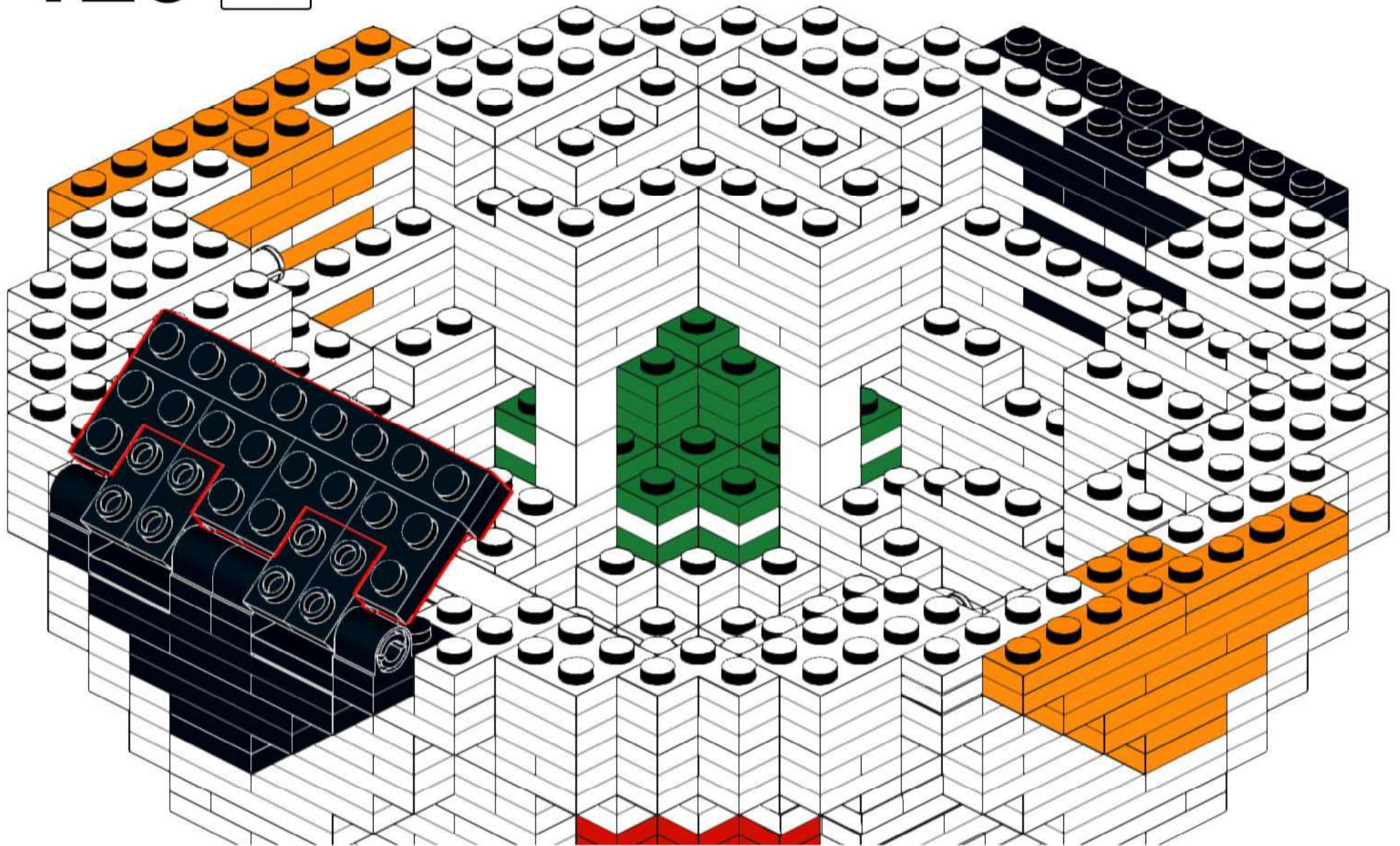

130

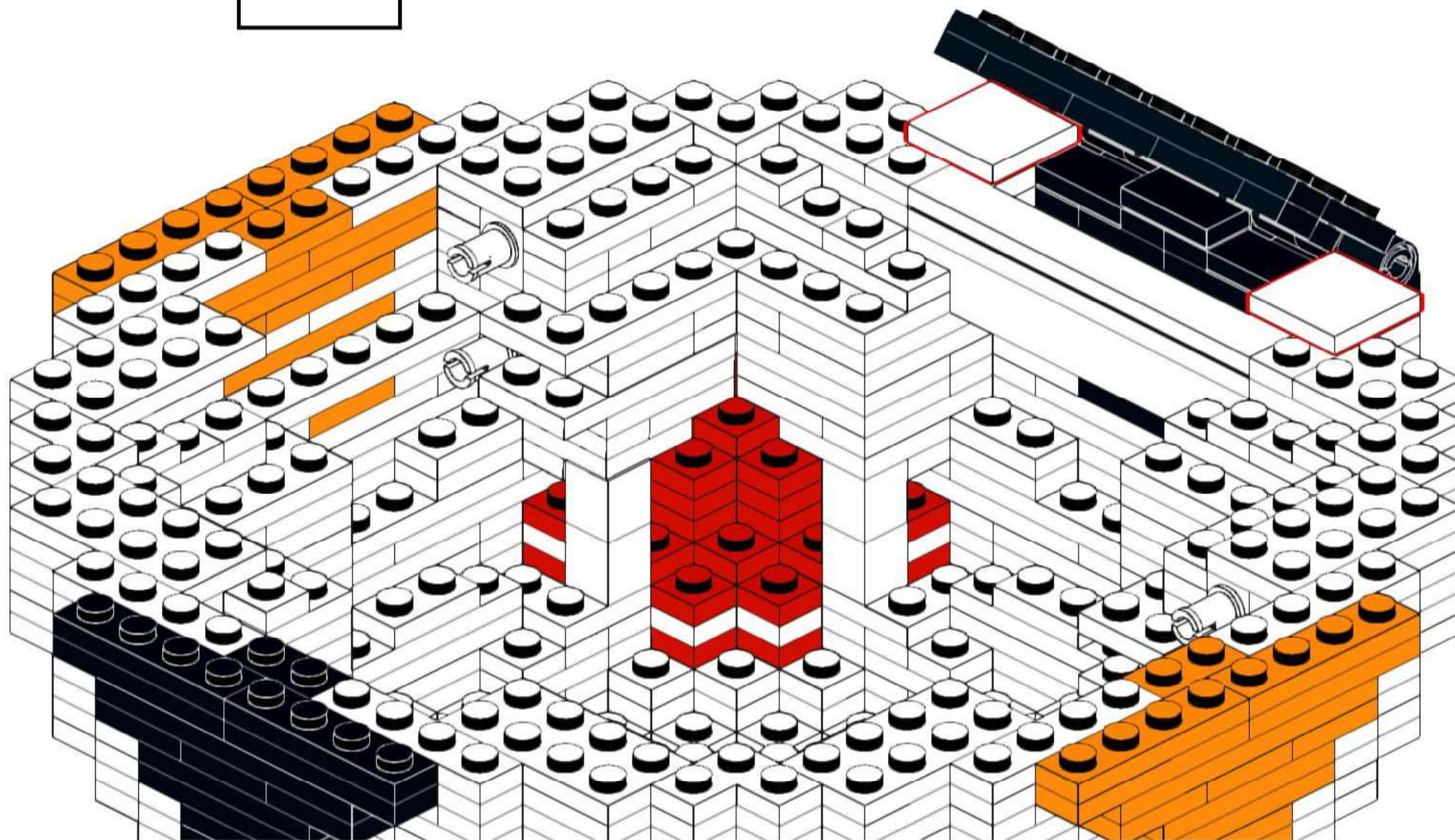
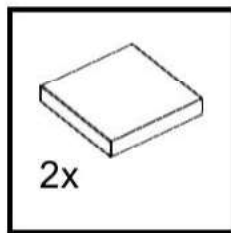

131

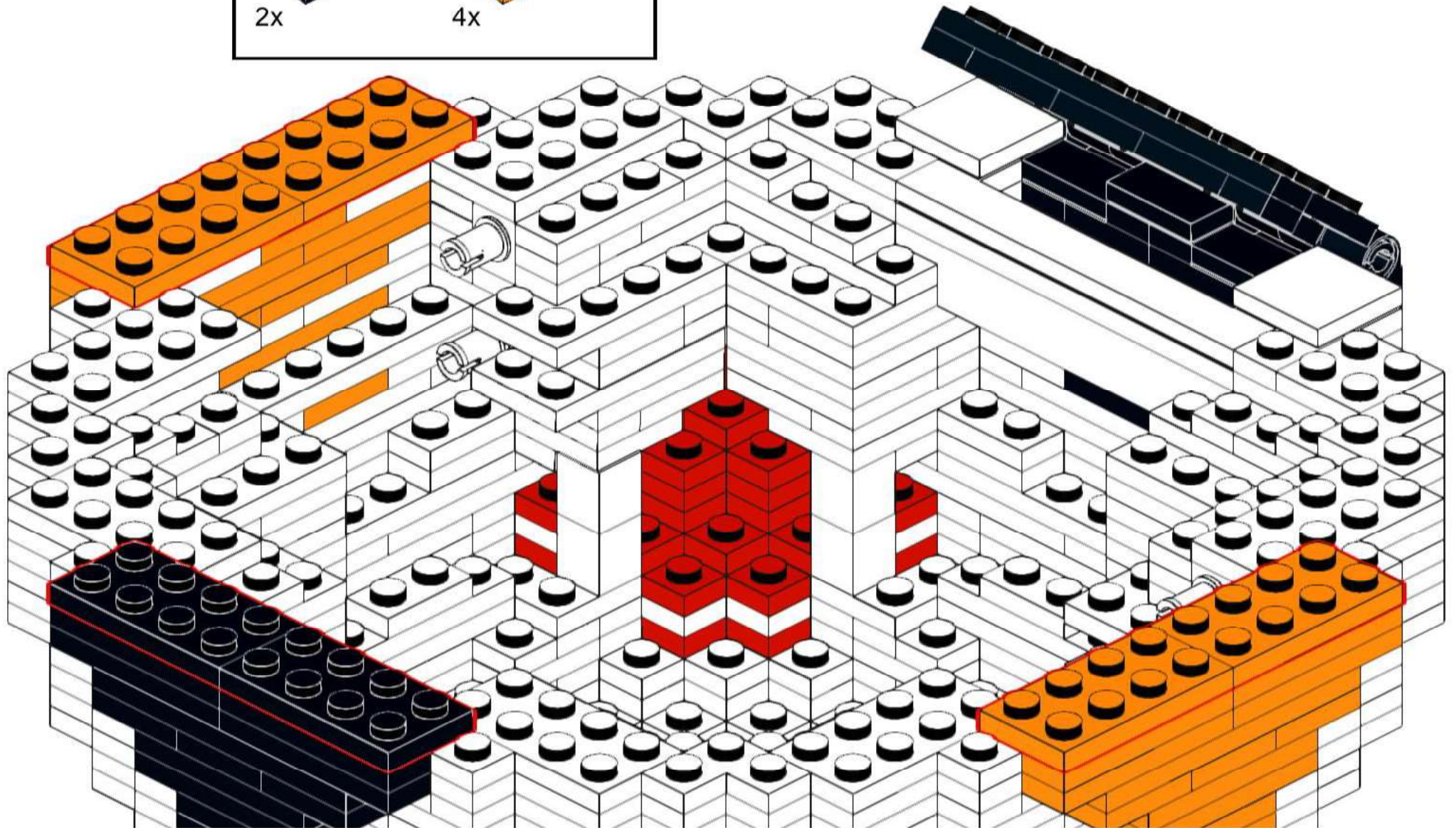
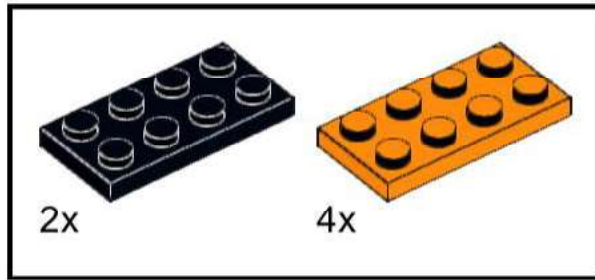

132

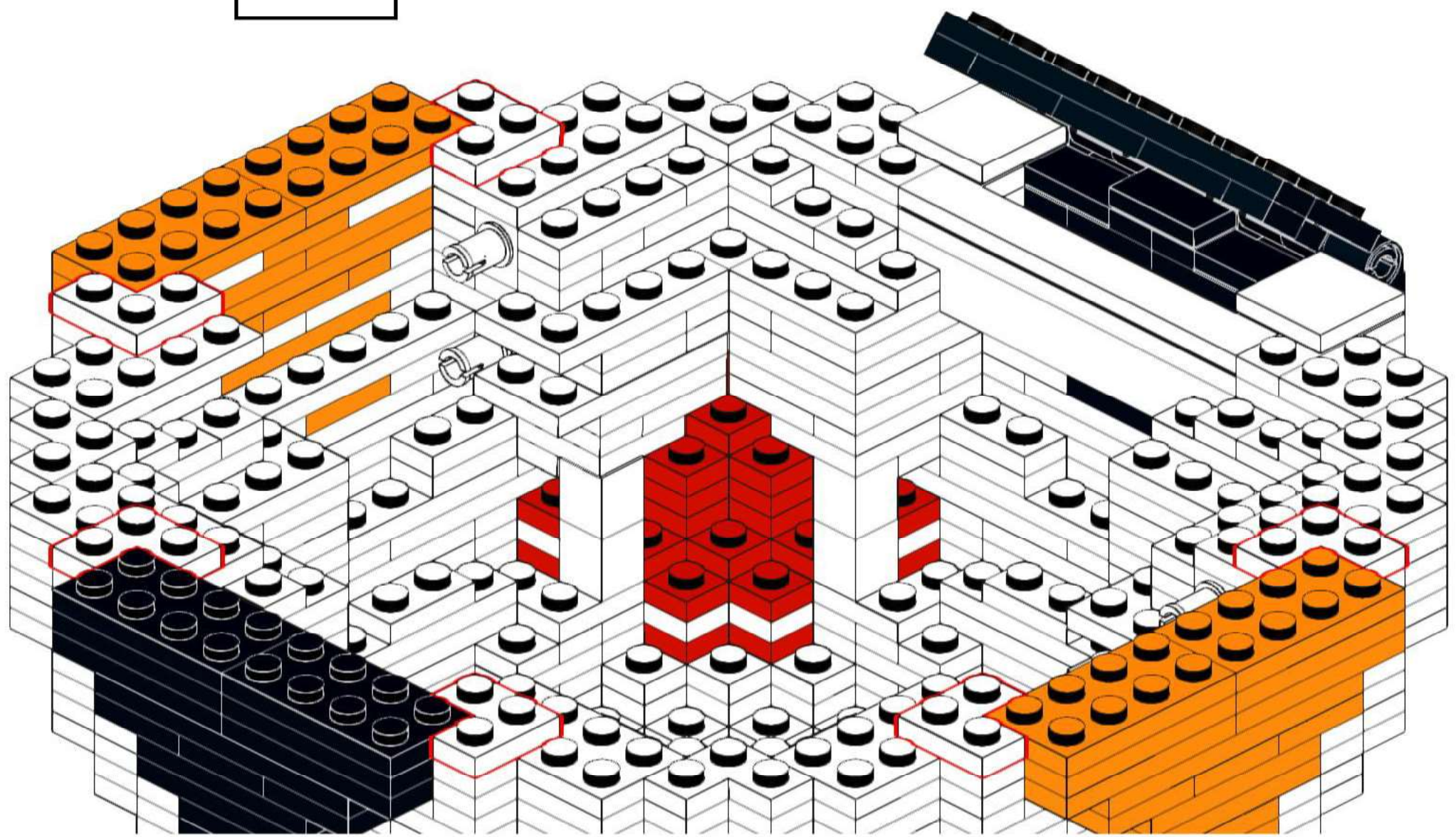
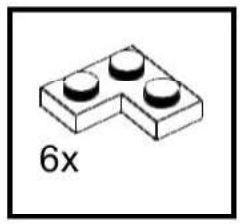

133

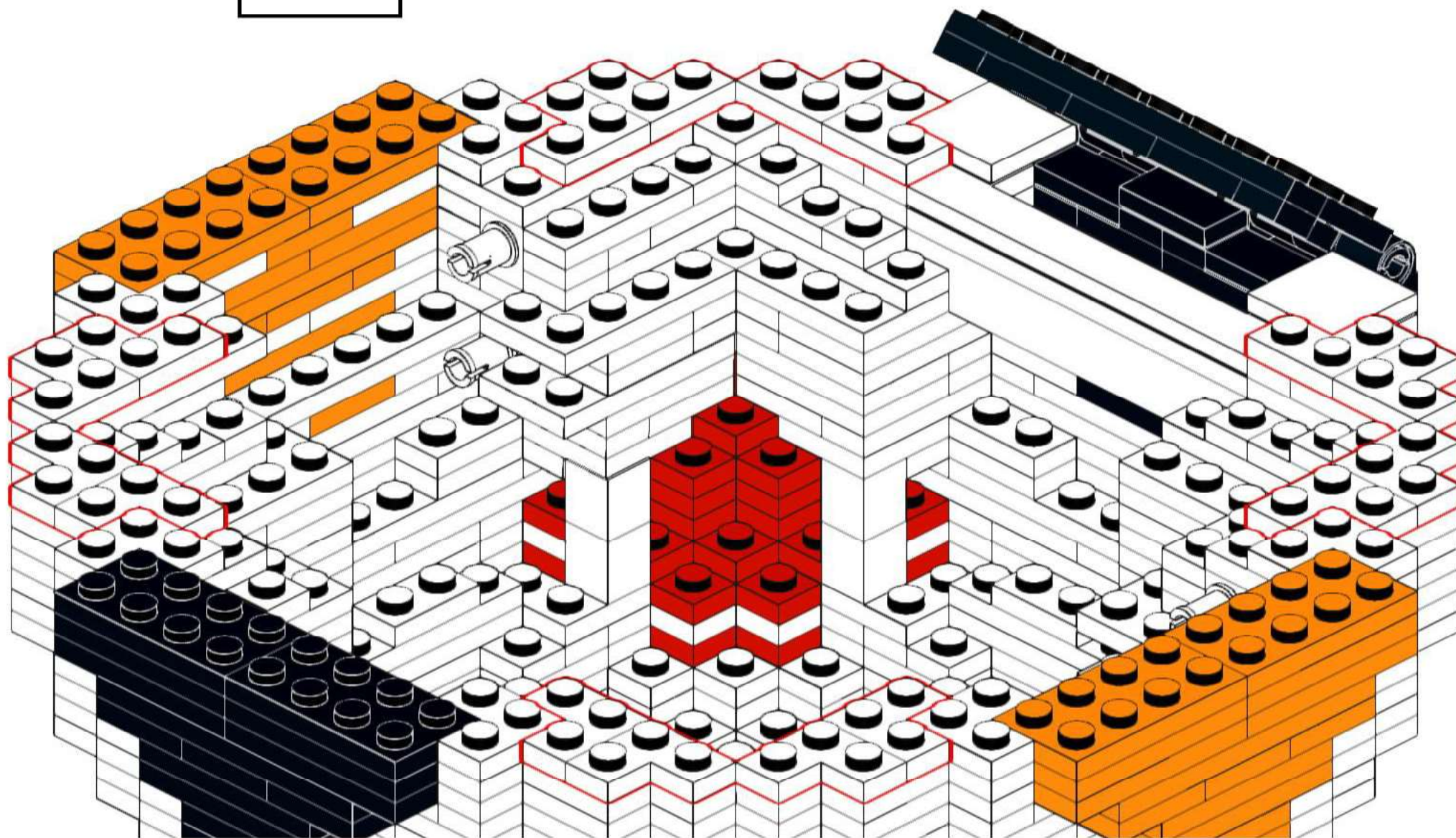
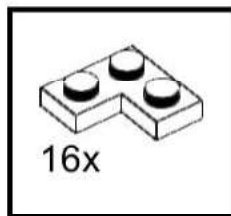

134

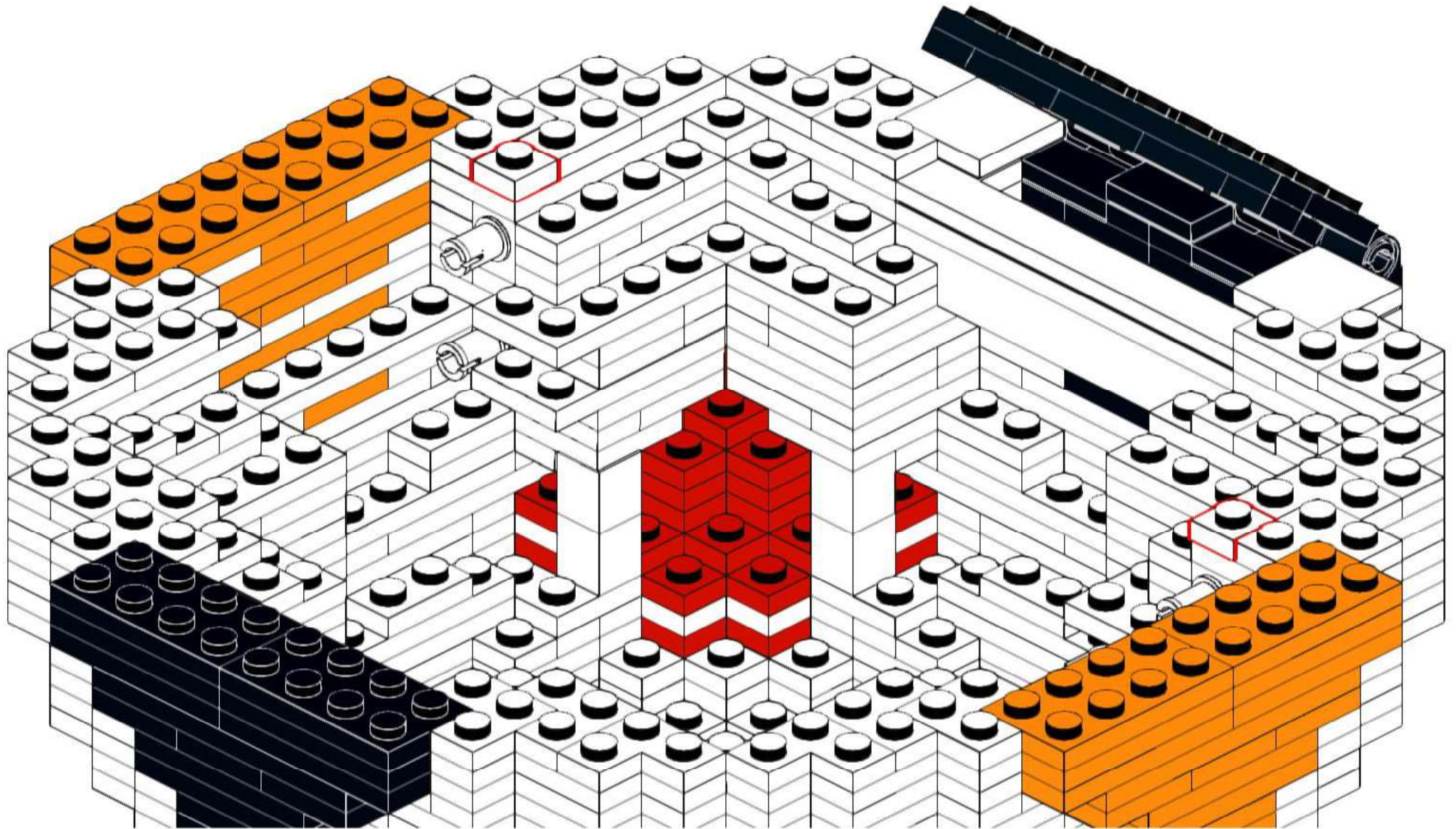
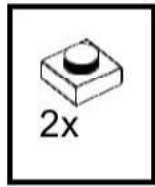

135

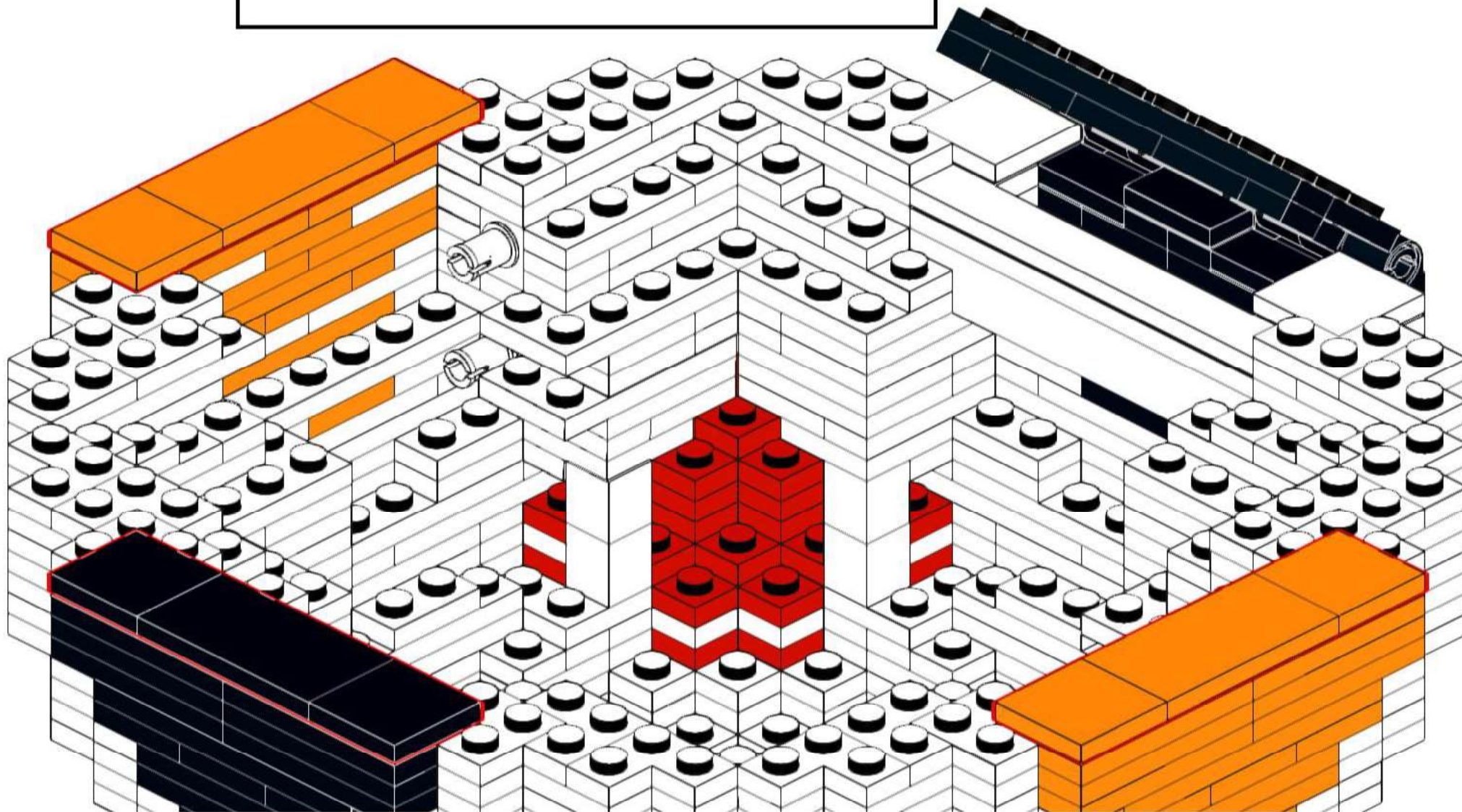
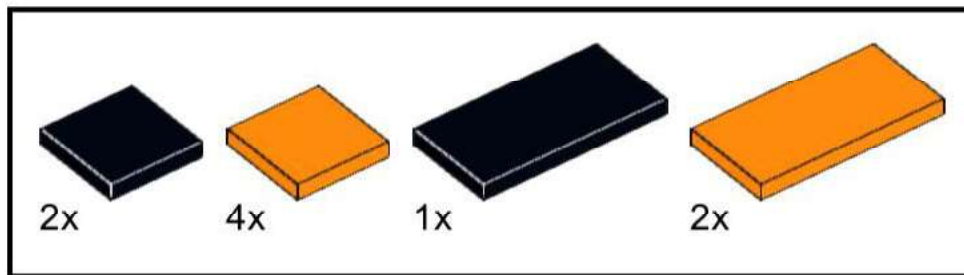

136

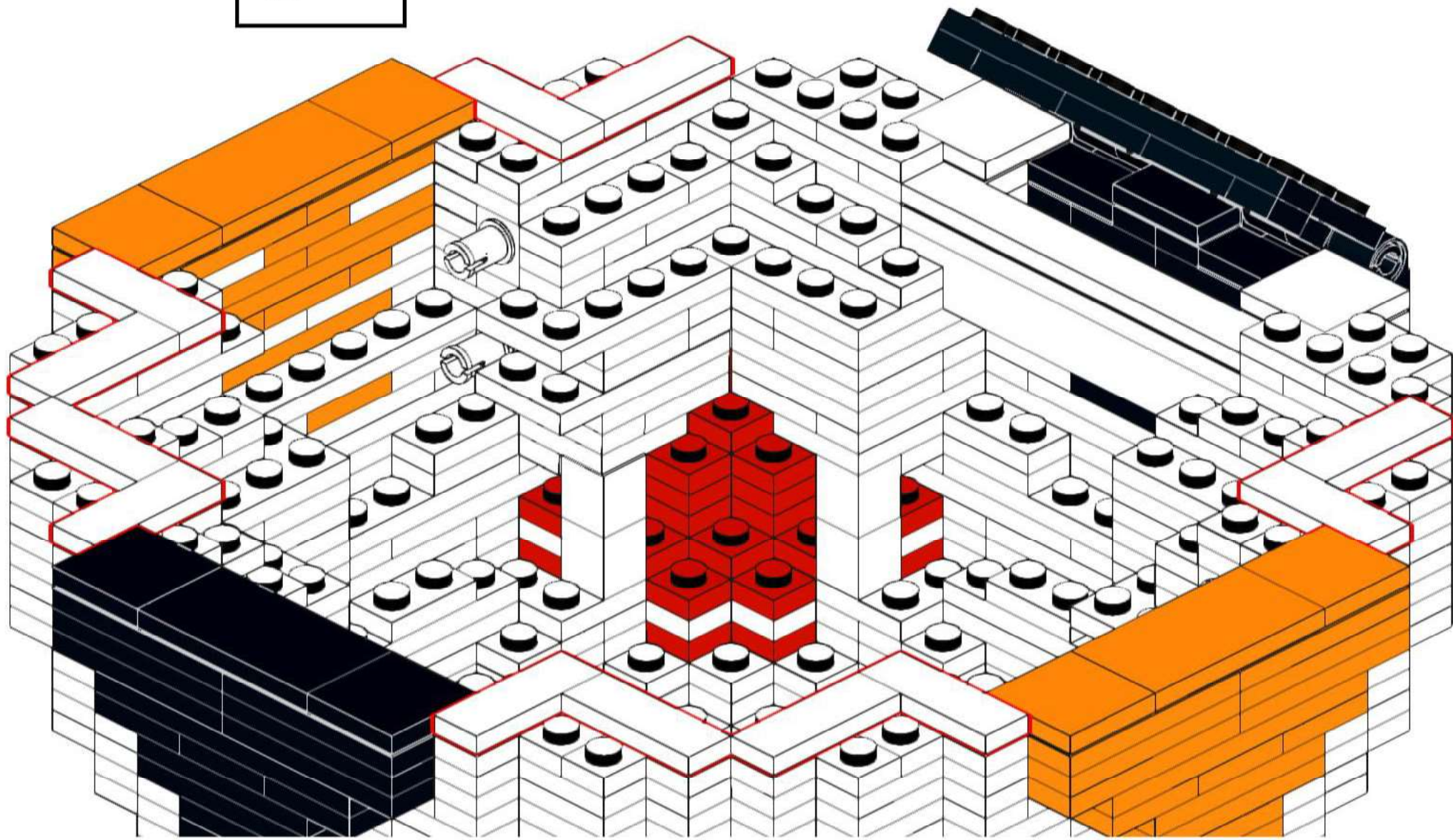
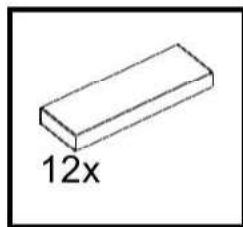

137

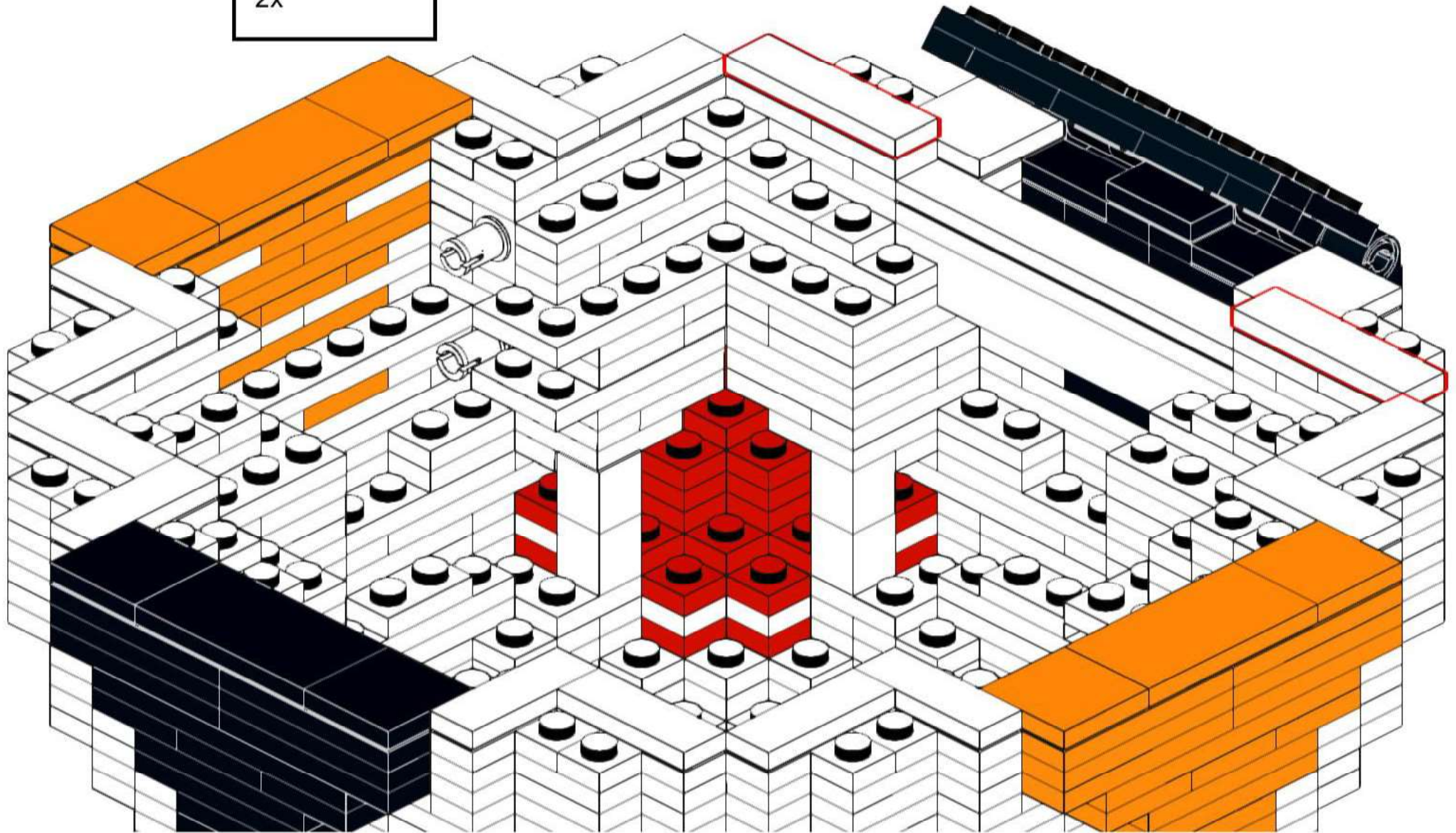
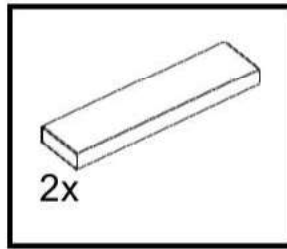

138

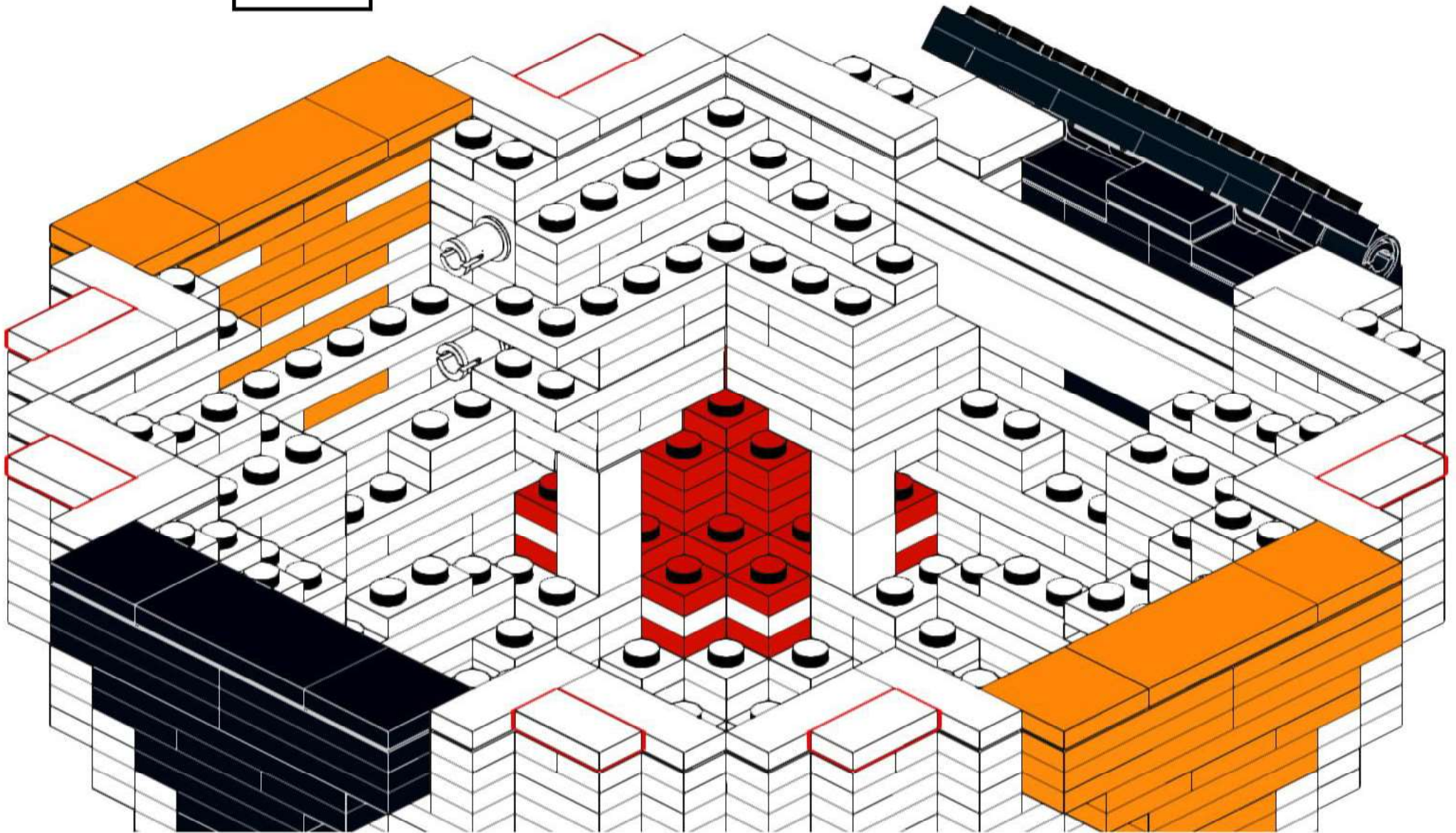
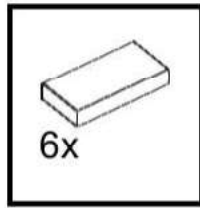

139

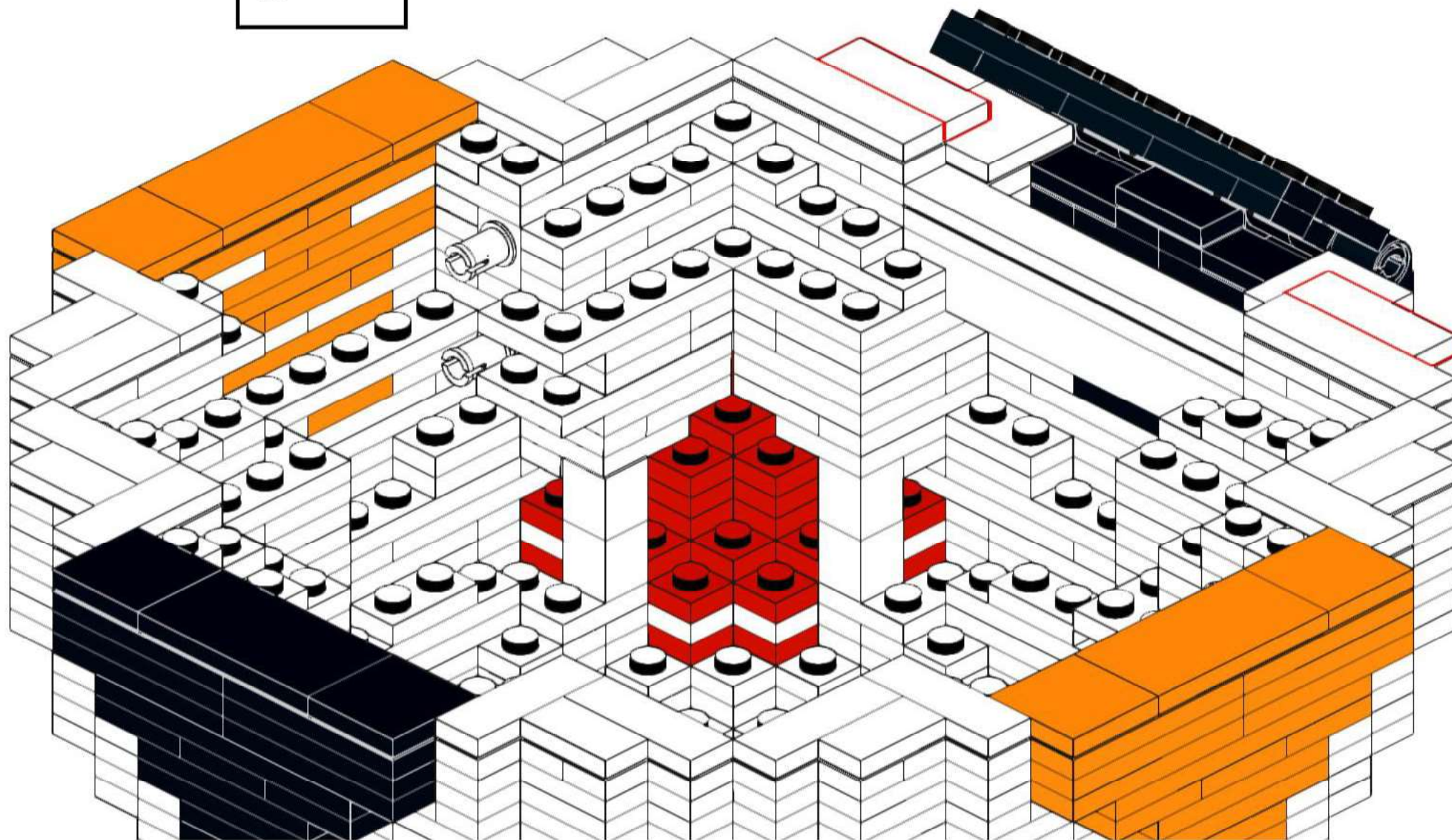
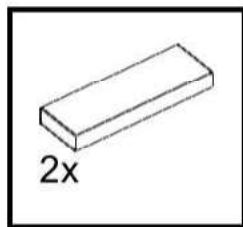

140

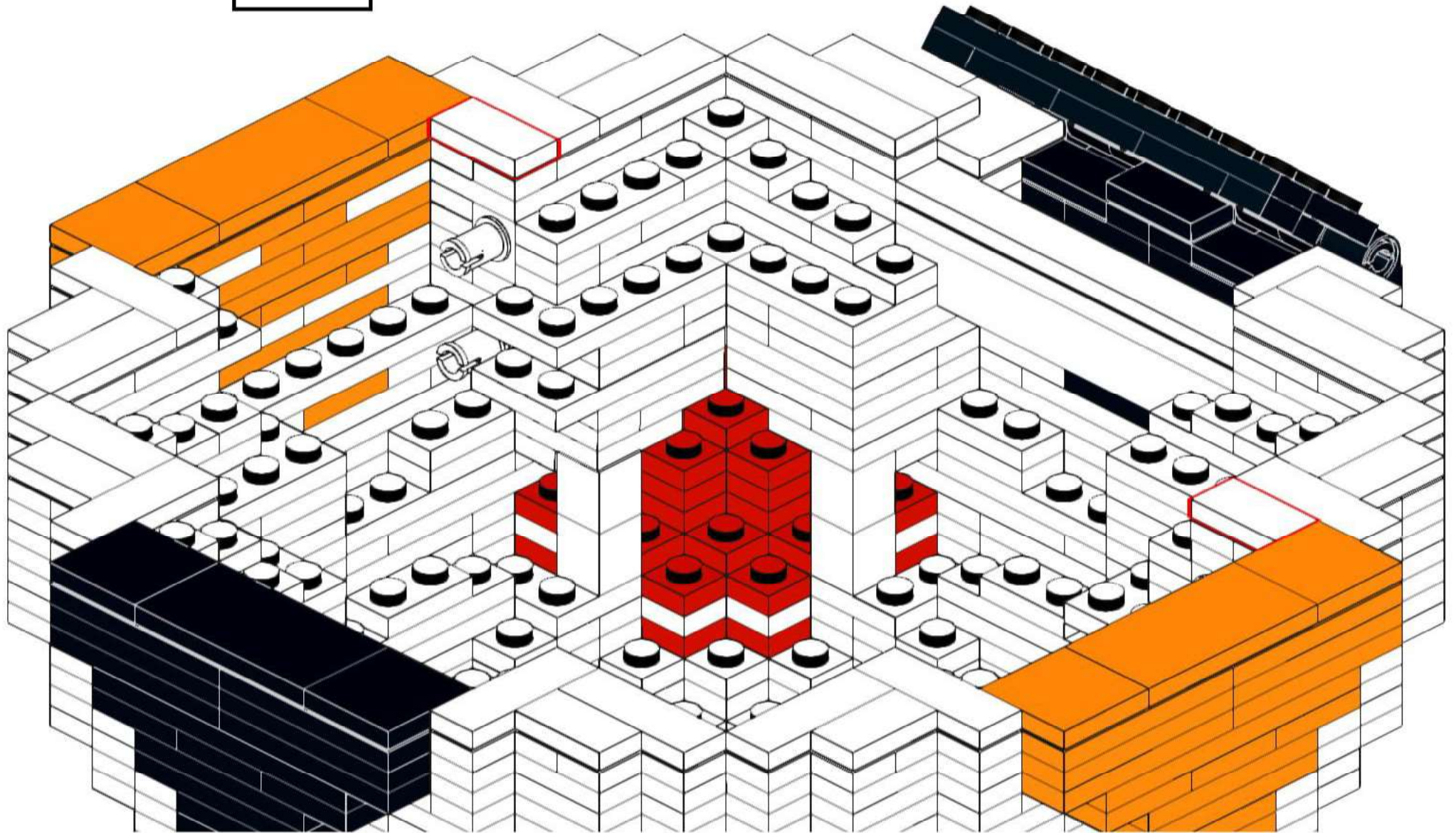
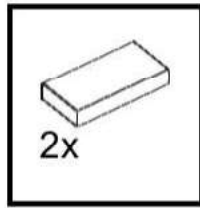

141

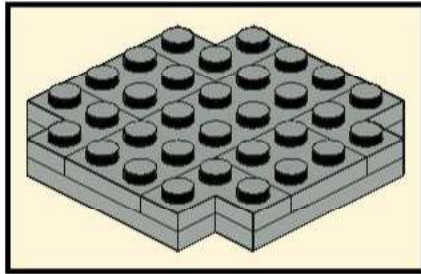

142

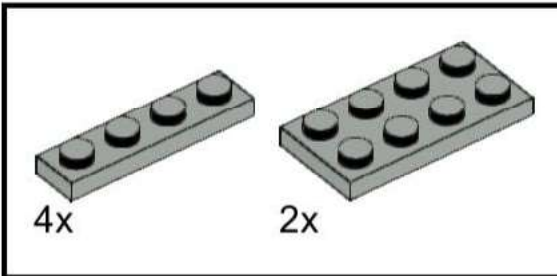
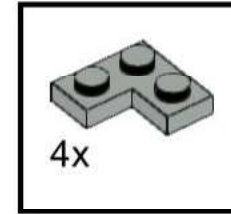

Dieses Bauteil für eine bessere Stabilität weglassen.

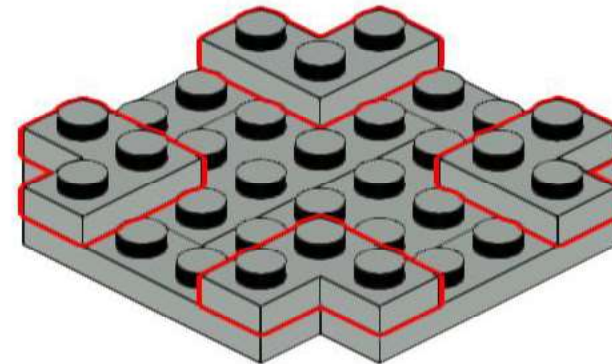
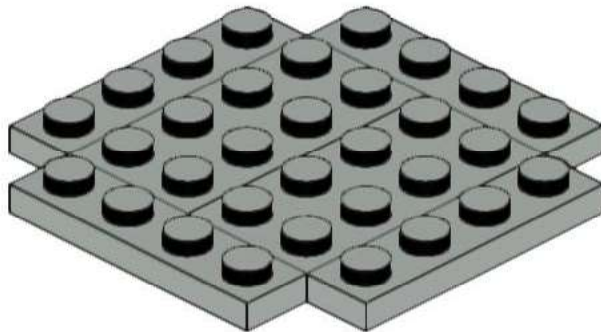

143

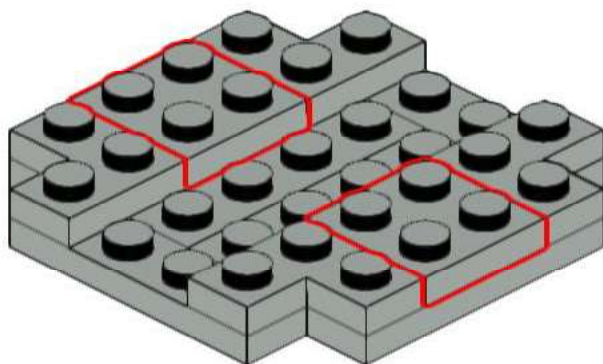
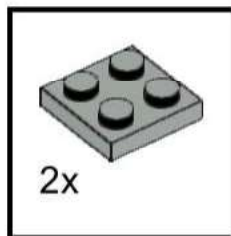

144

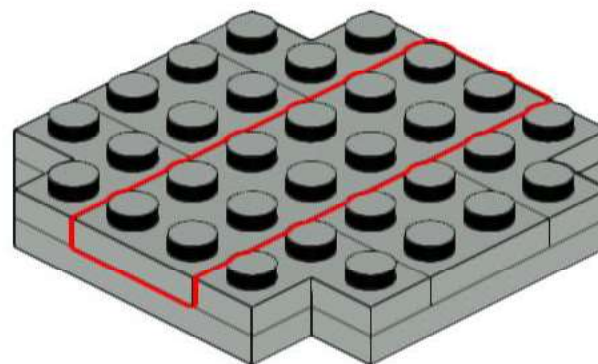
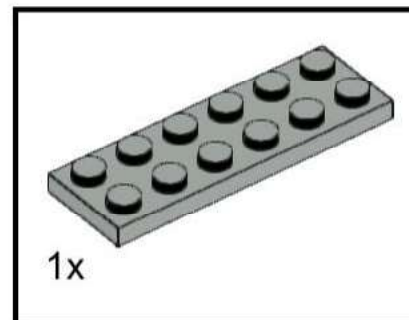

145



Optional
(Standfestigkeit)
(Stability)

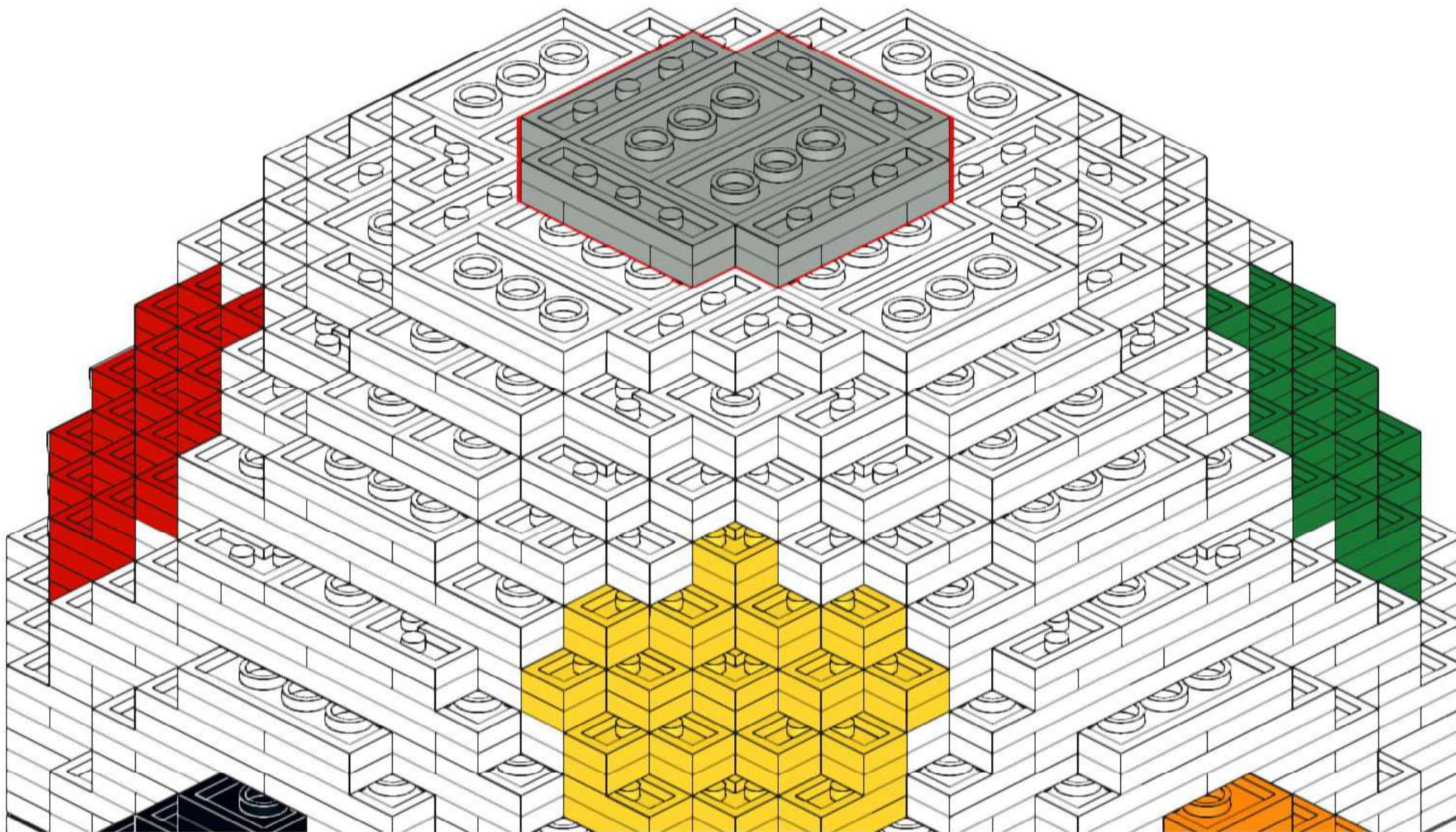

146

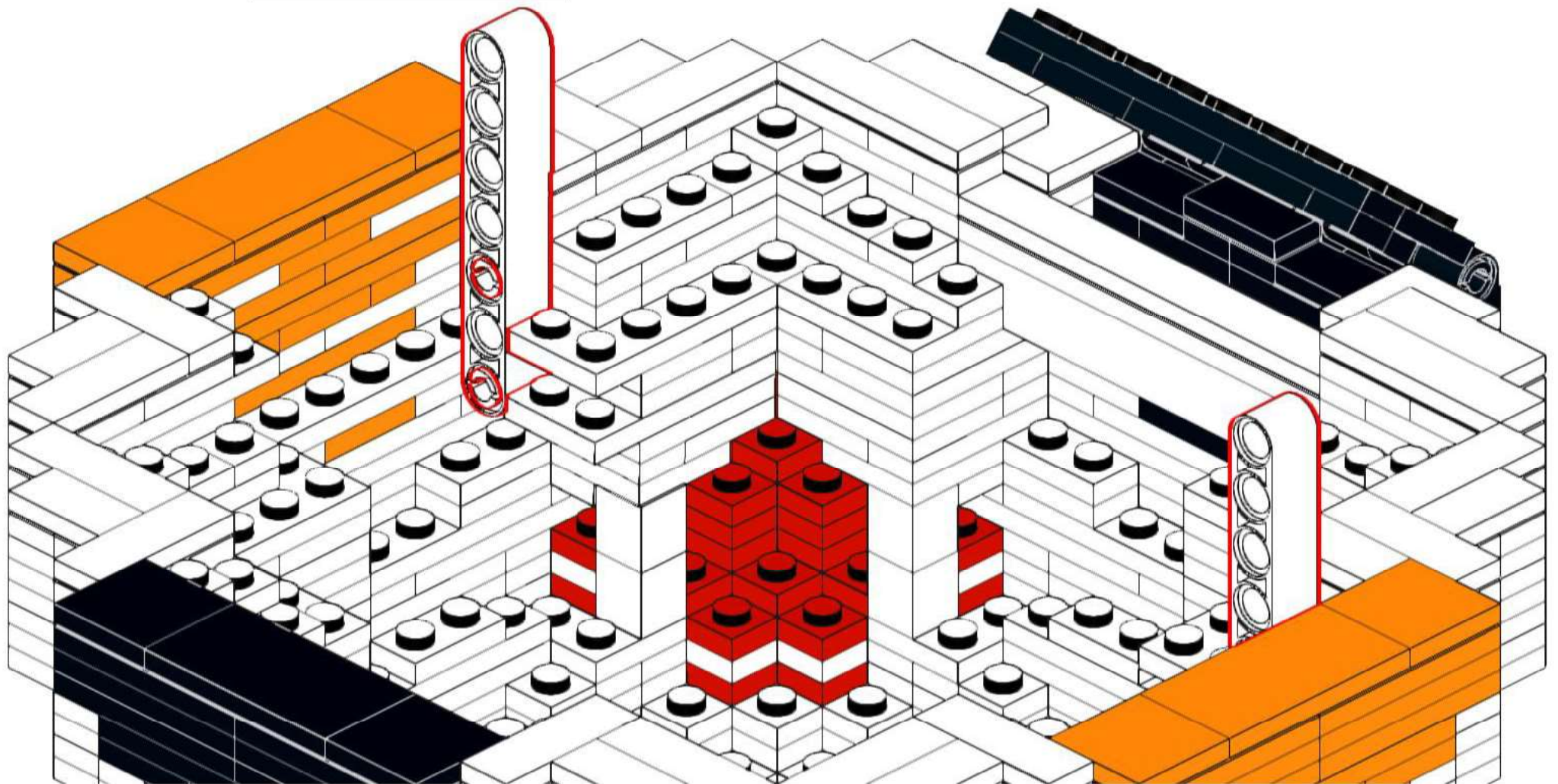
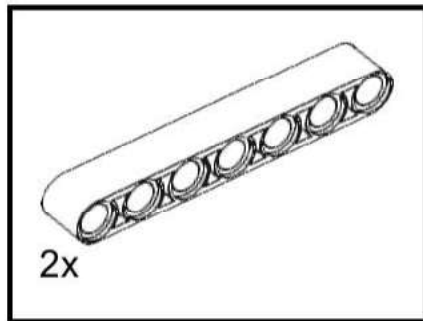

147

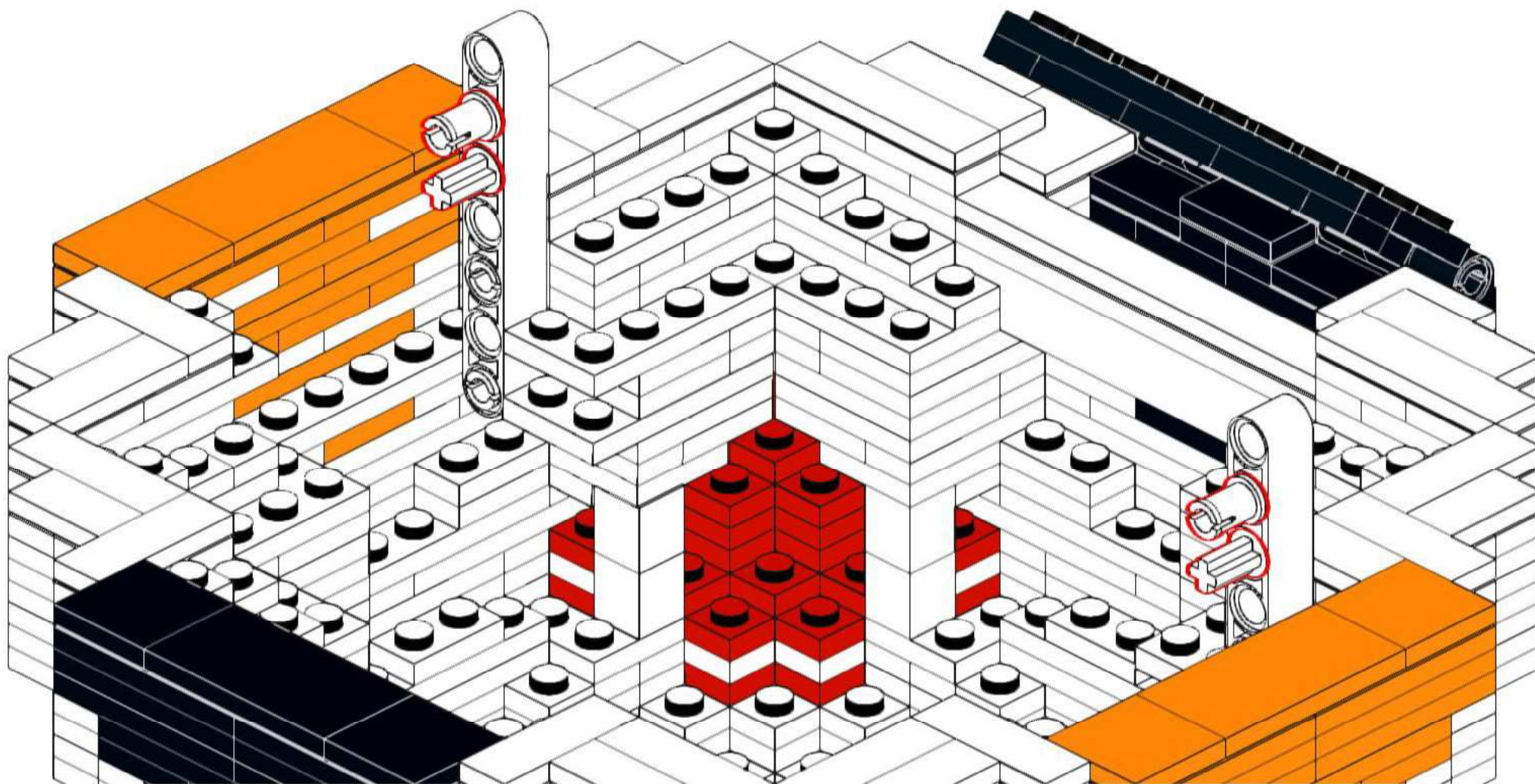
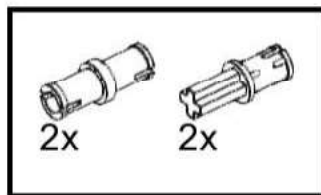

148

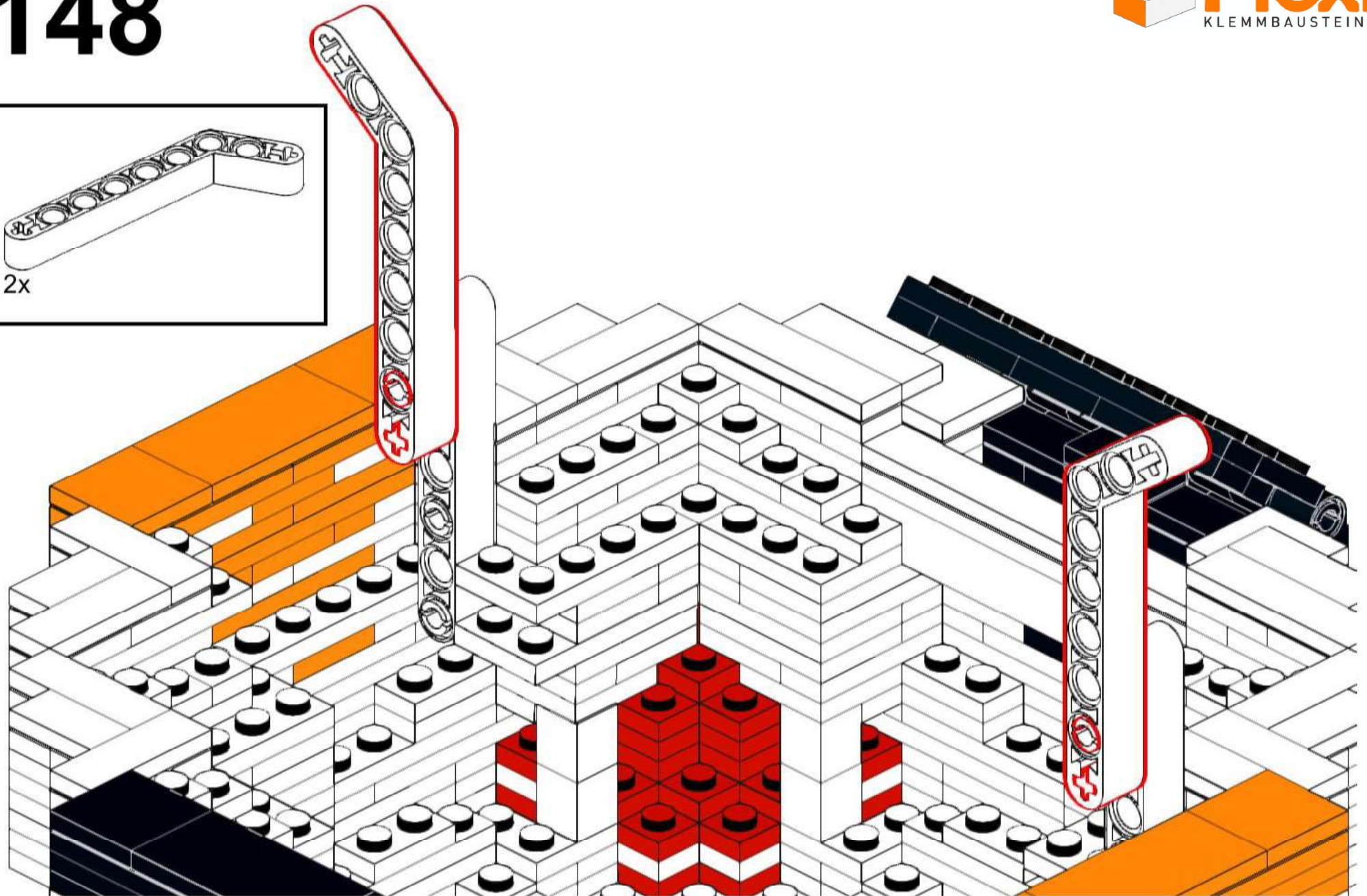
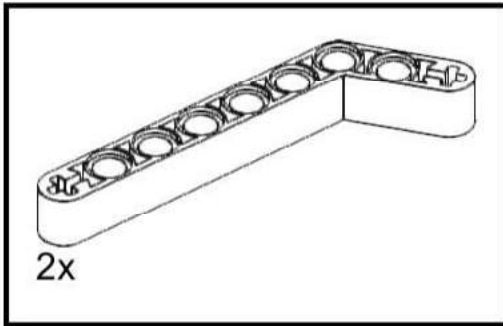

149

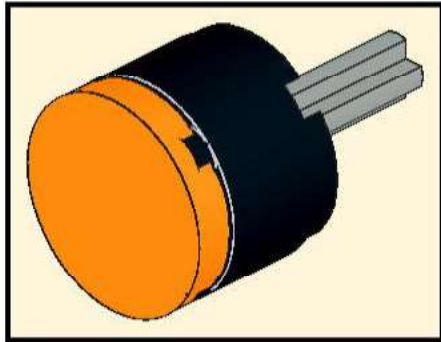

2x

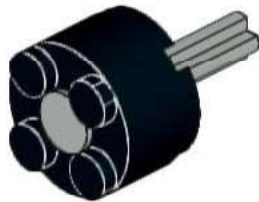
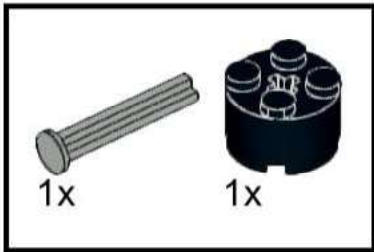

150

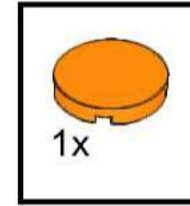

1x

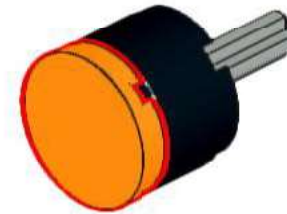

151

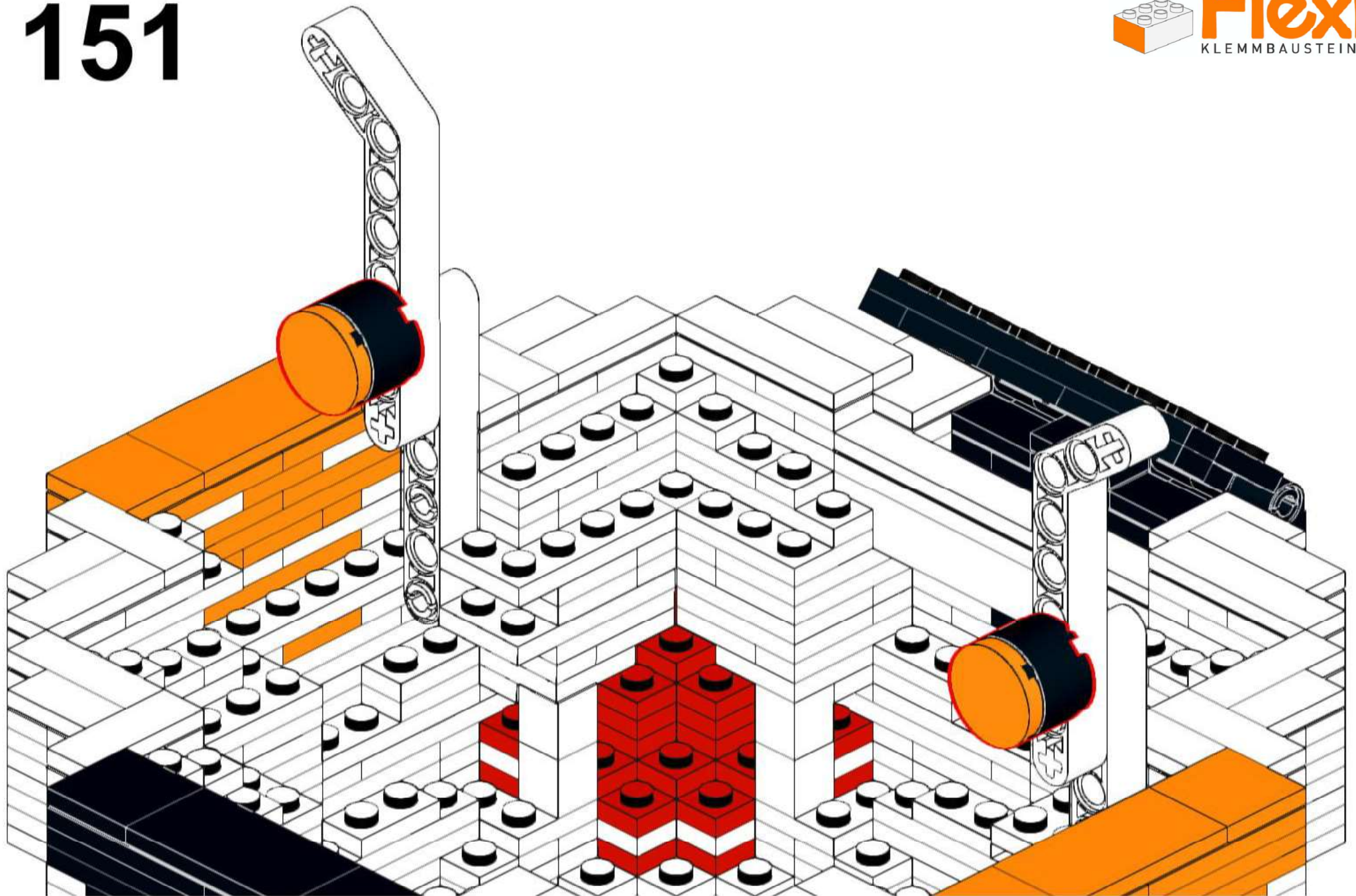

152

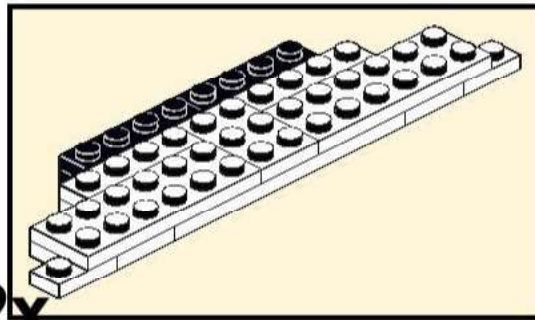

2x

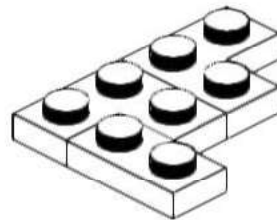
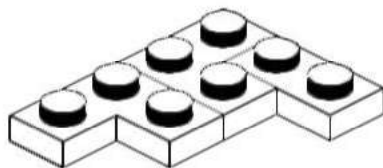
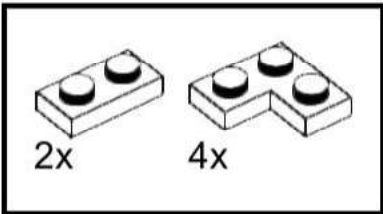

153

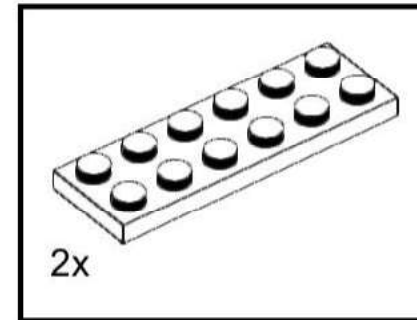

2x

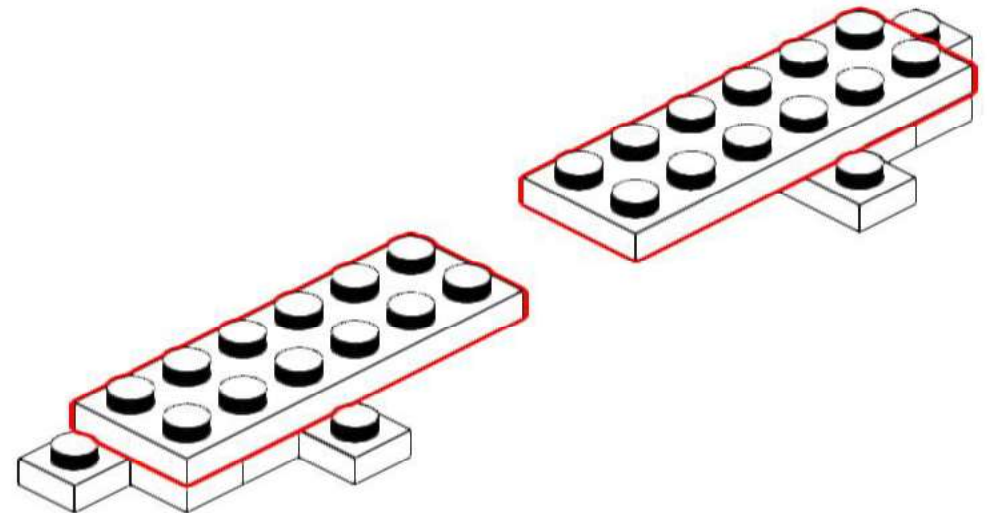

154

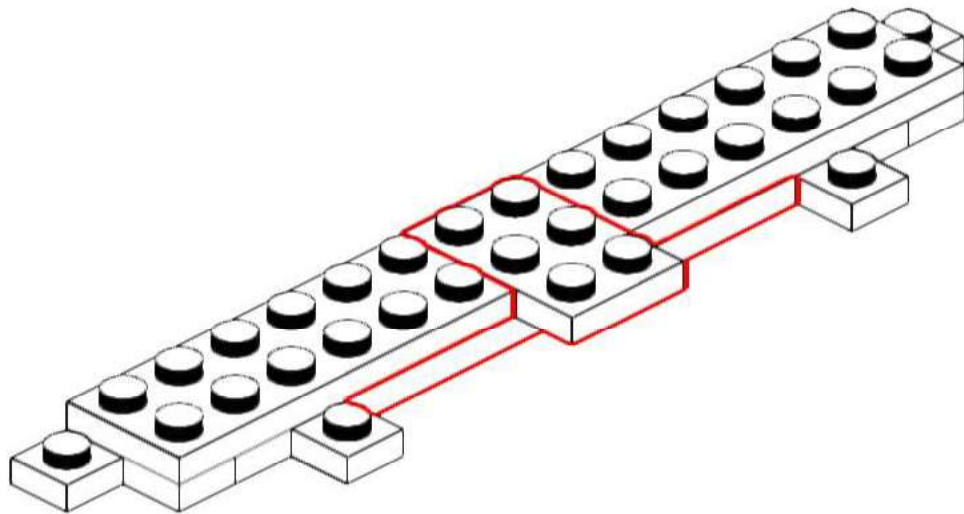
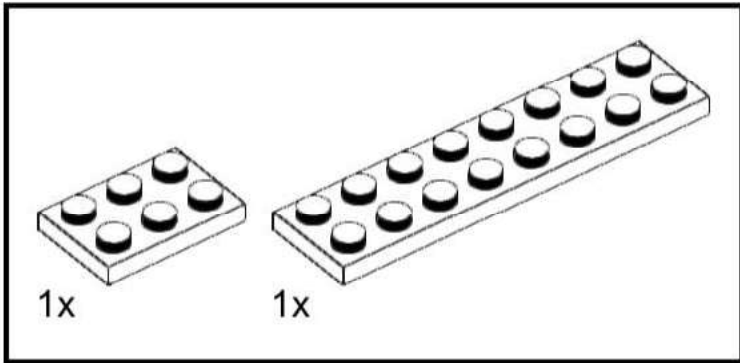

155

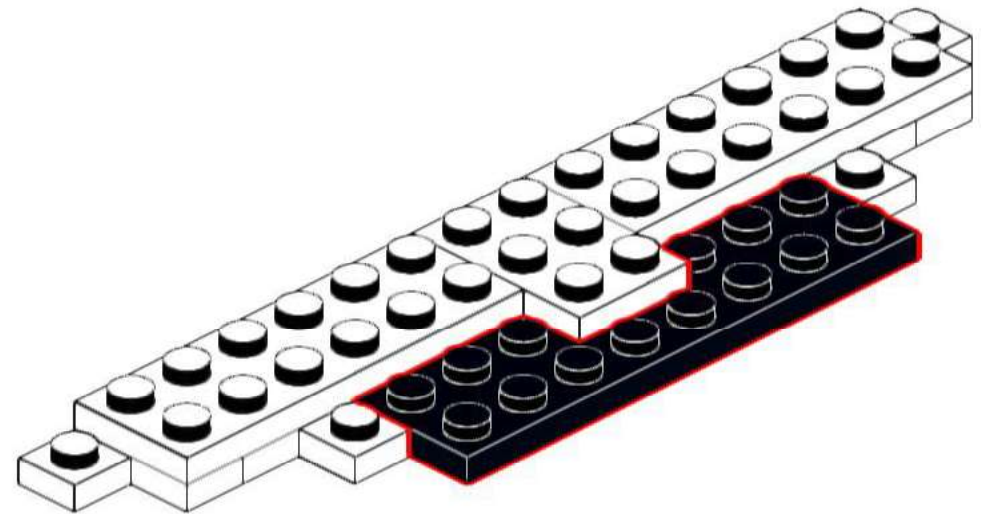
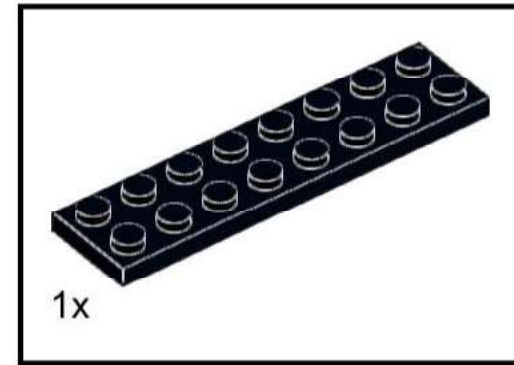

156

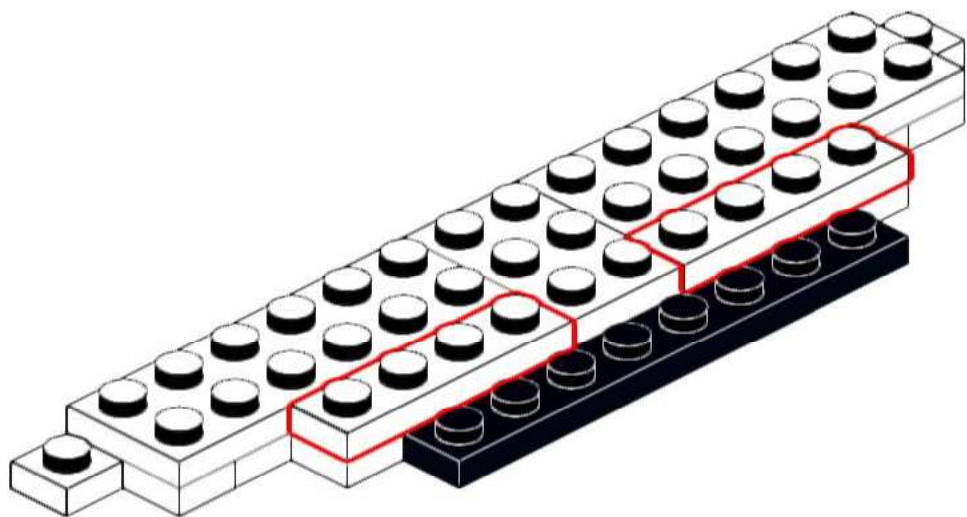
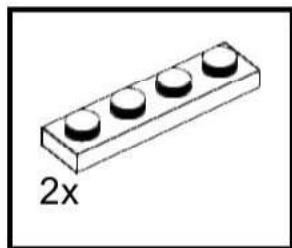

157

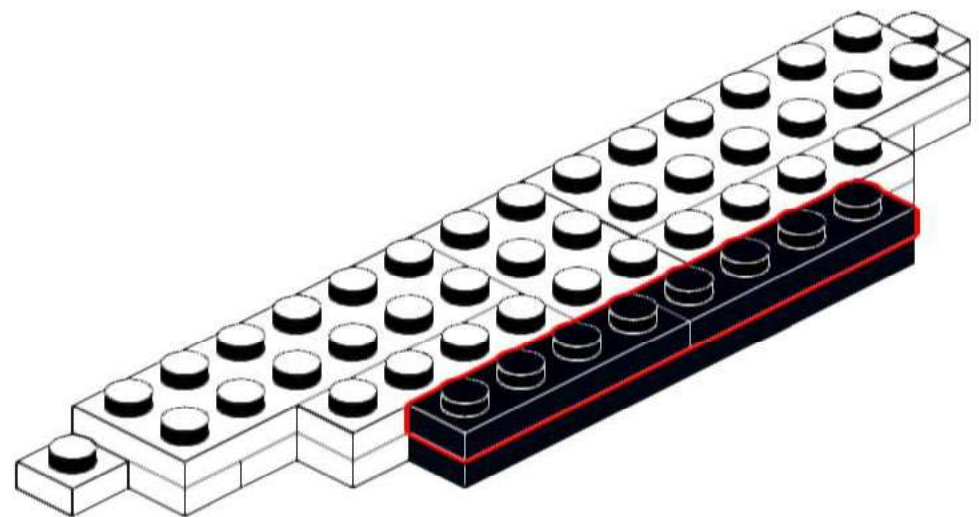
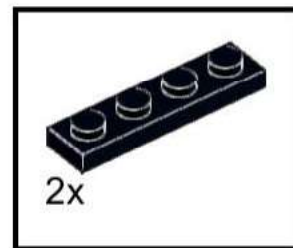

158

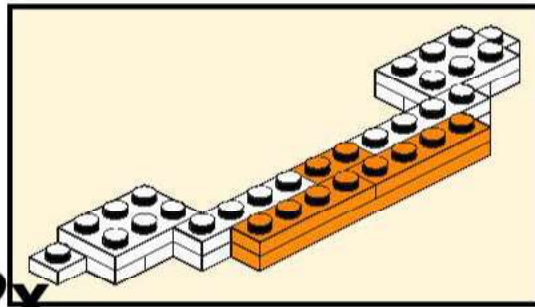

2x

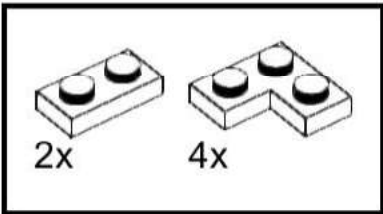

159

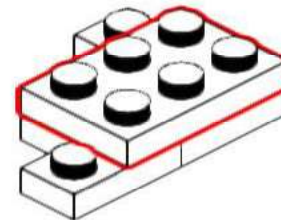
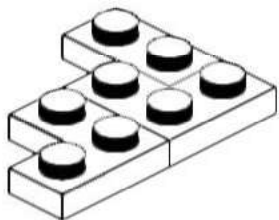
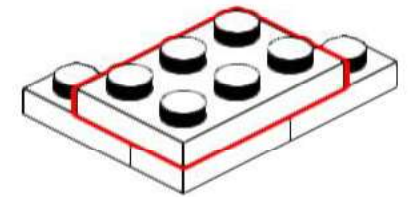
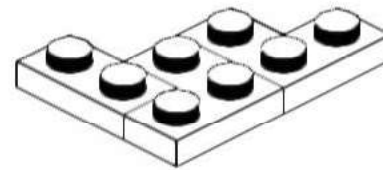
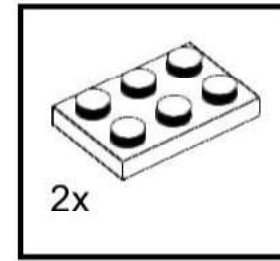

160

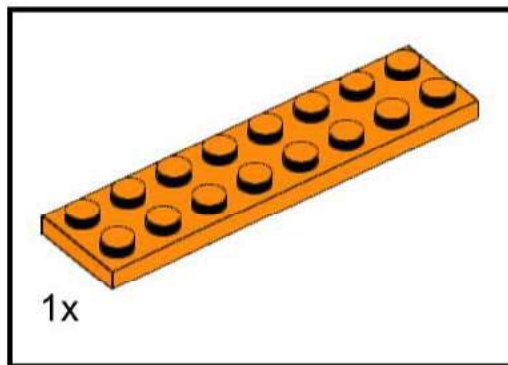

161

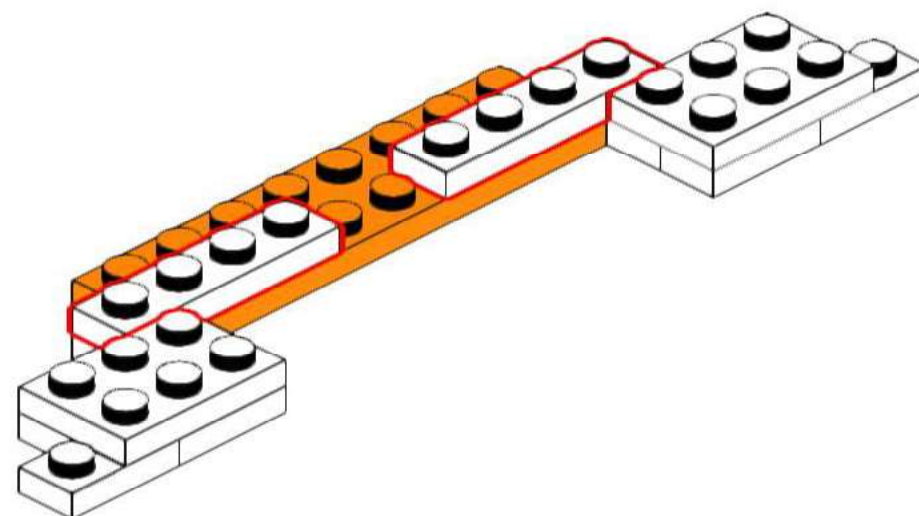
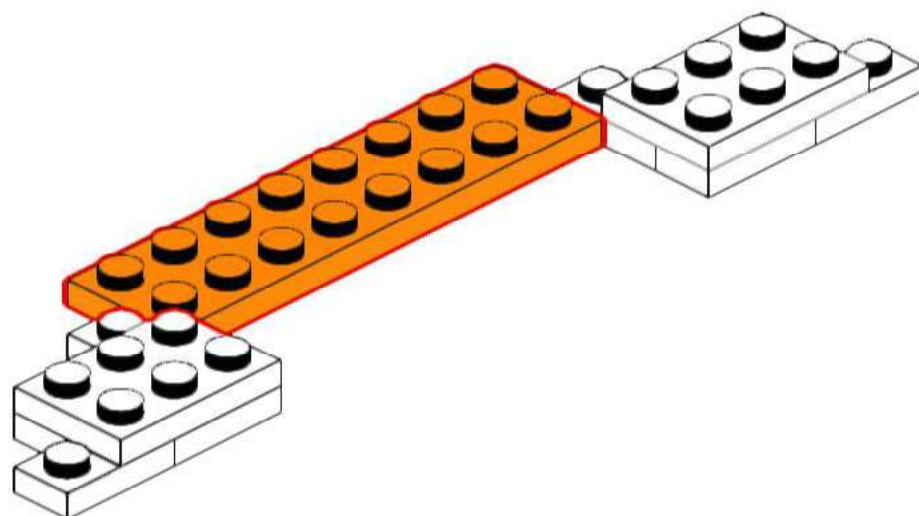
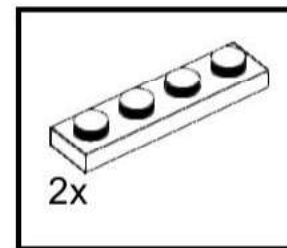

162

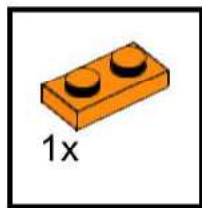

163

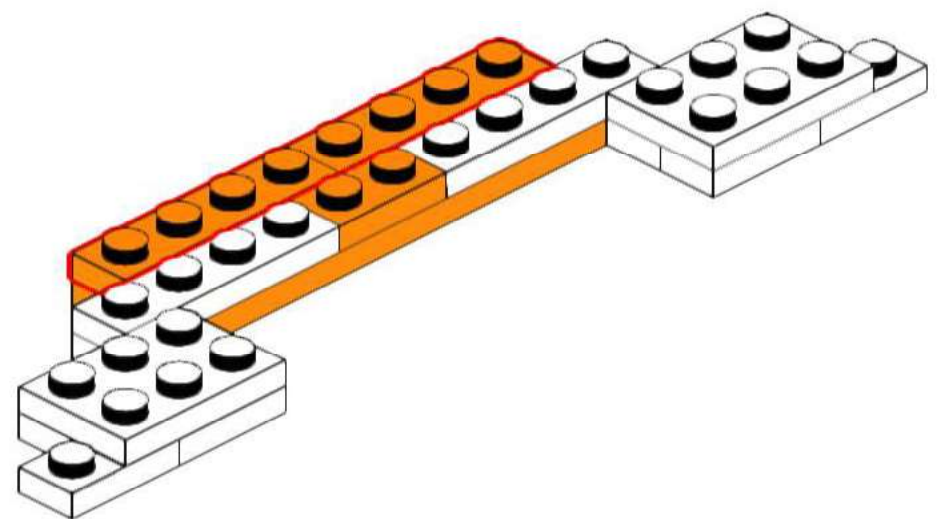
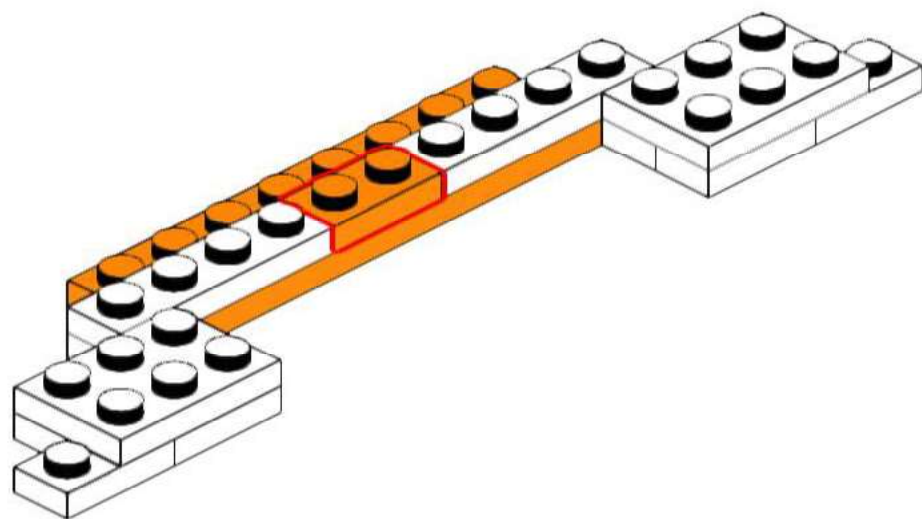
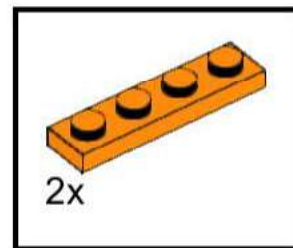

164

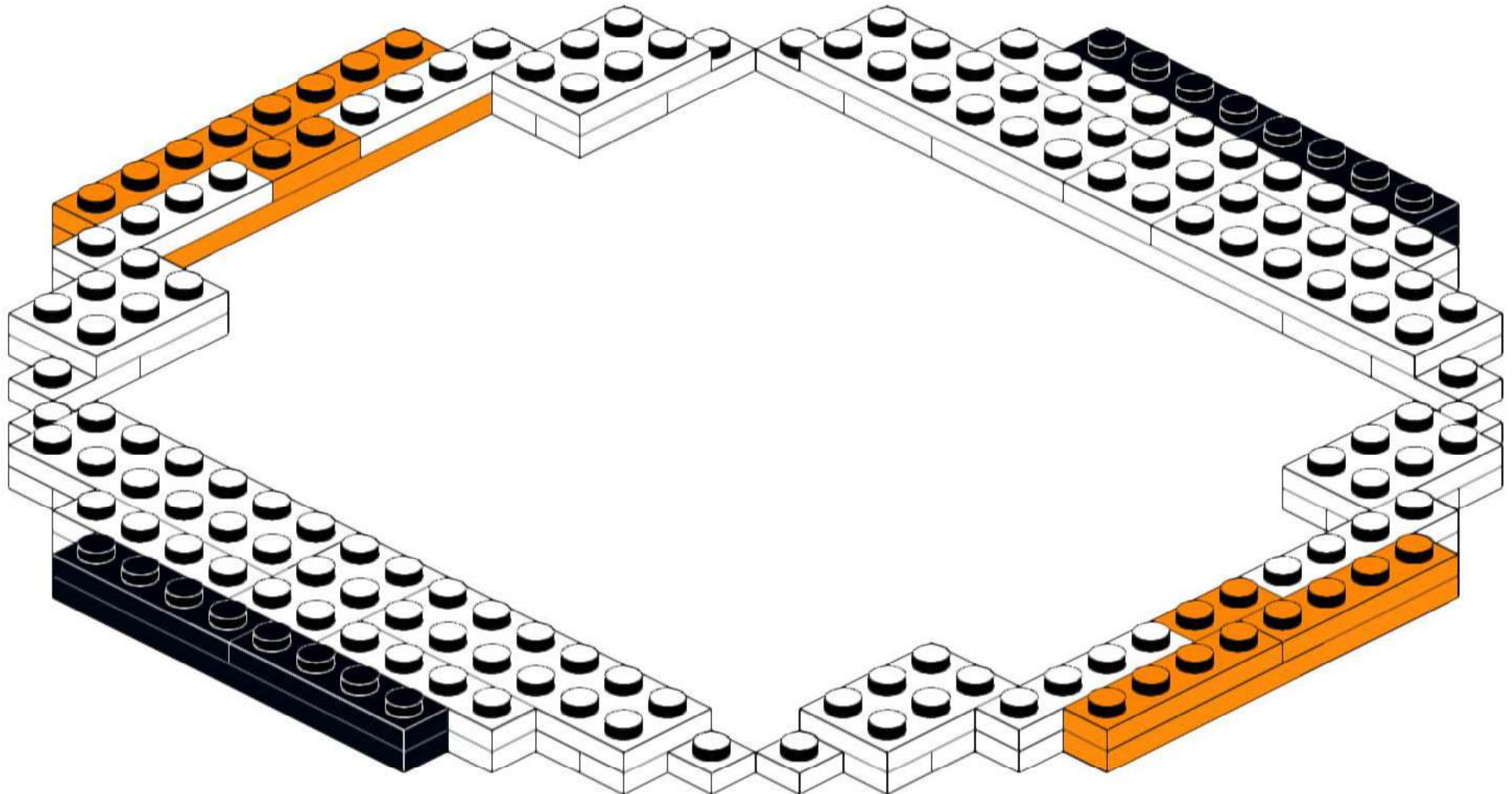
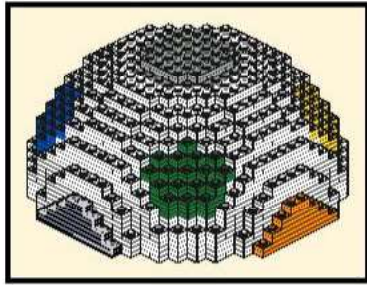

165

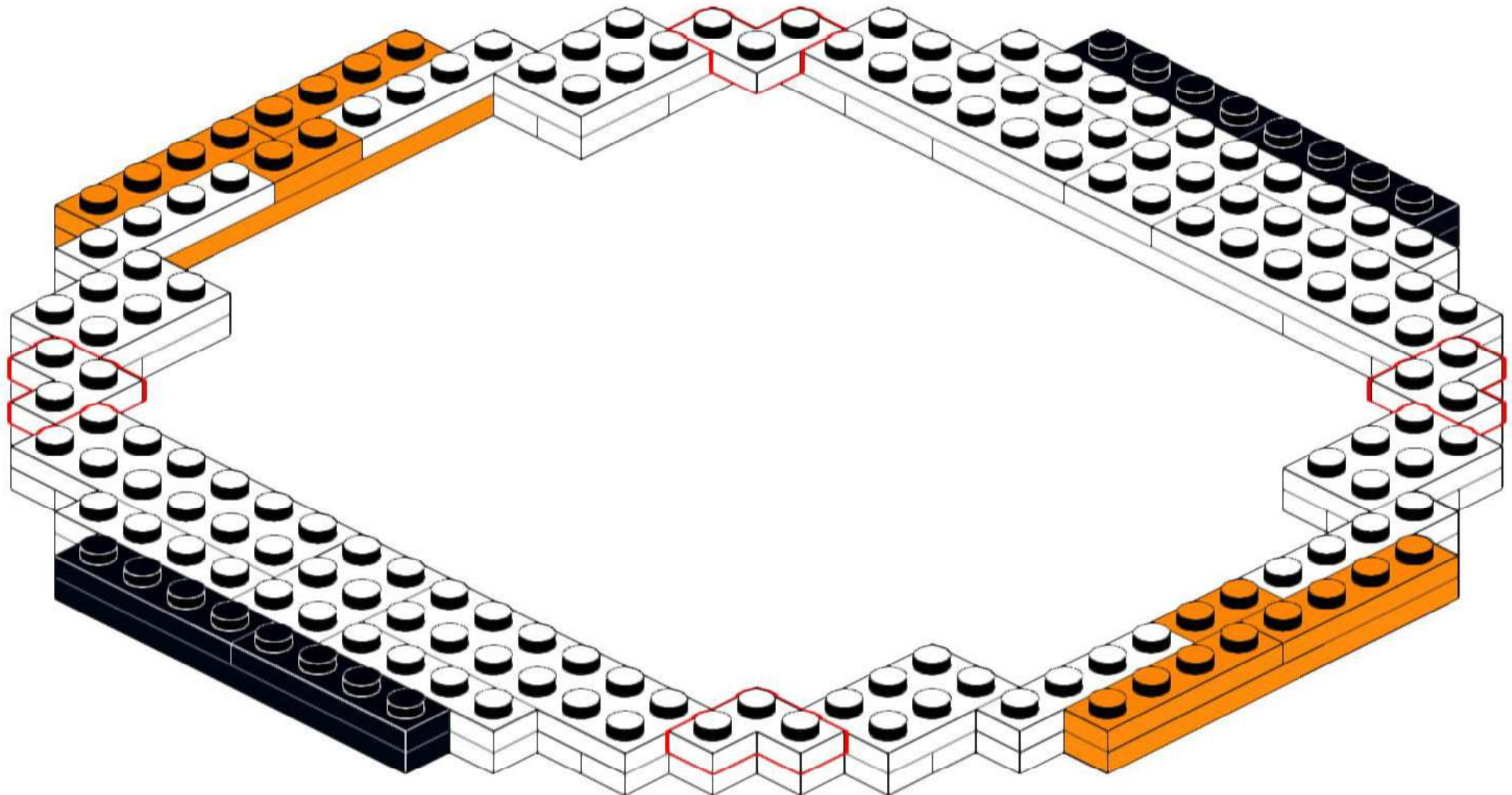
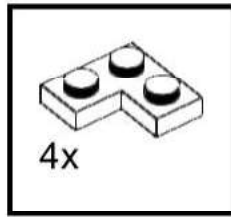

166

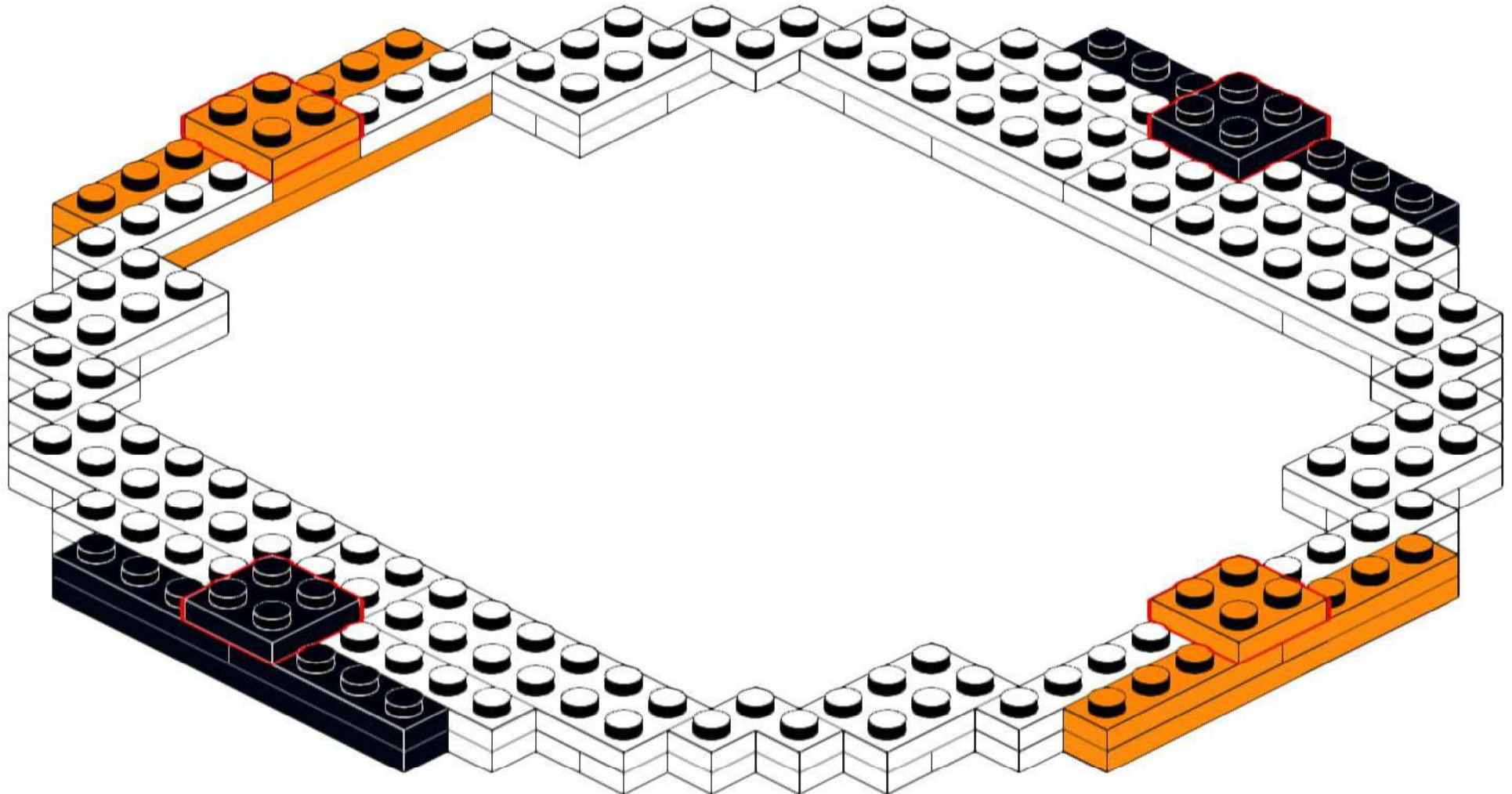
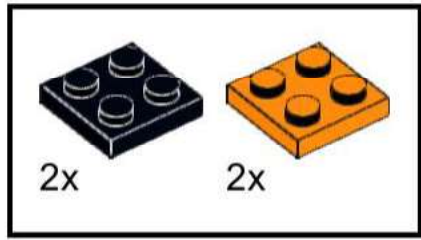

167

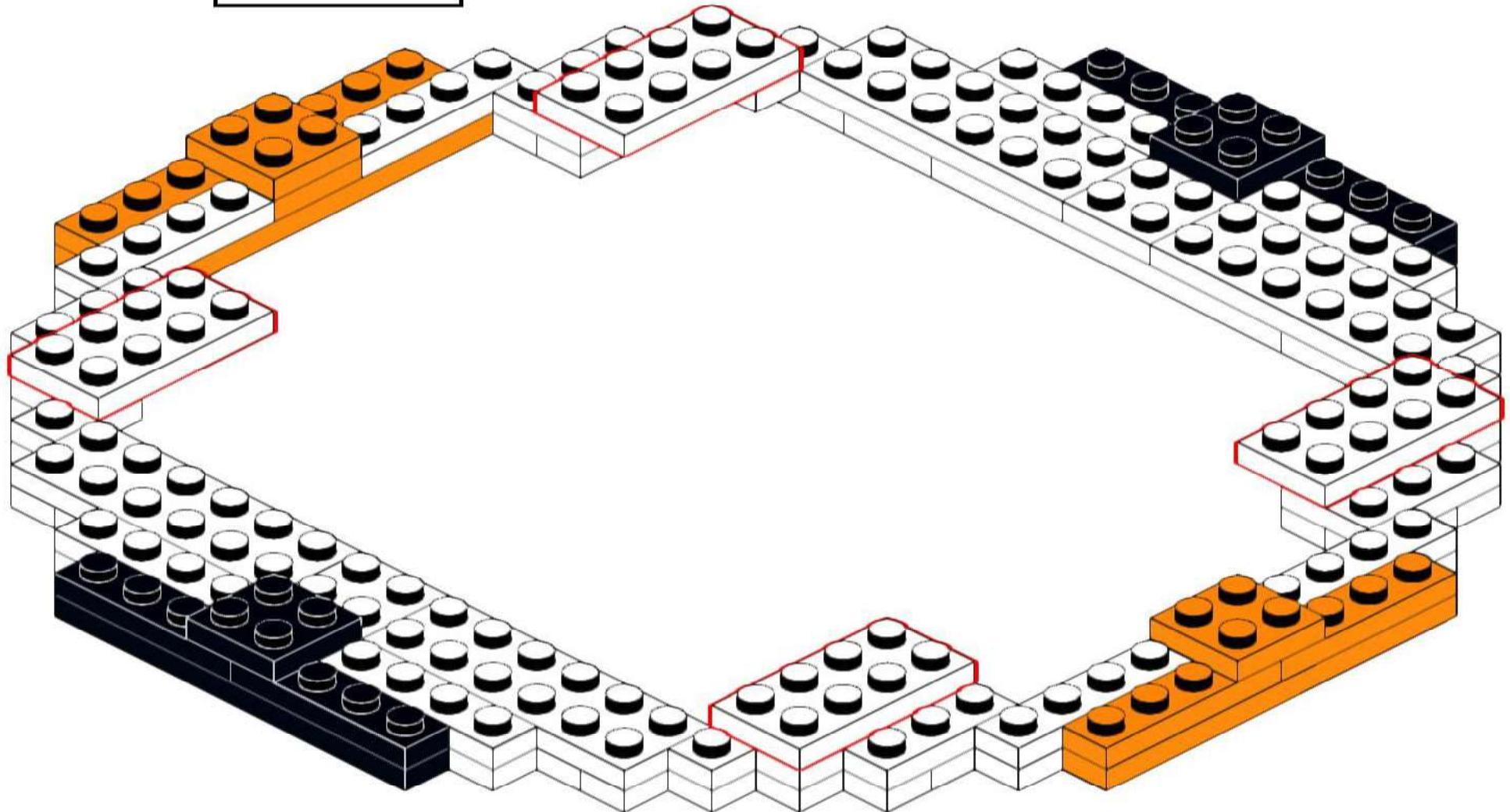
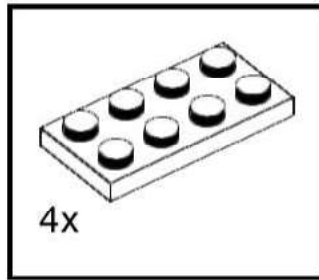

168

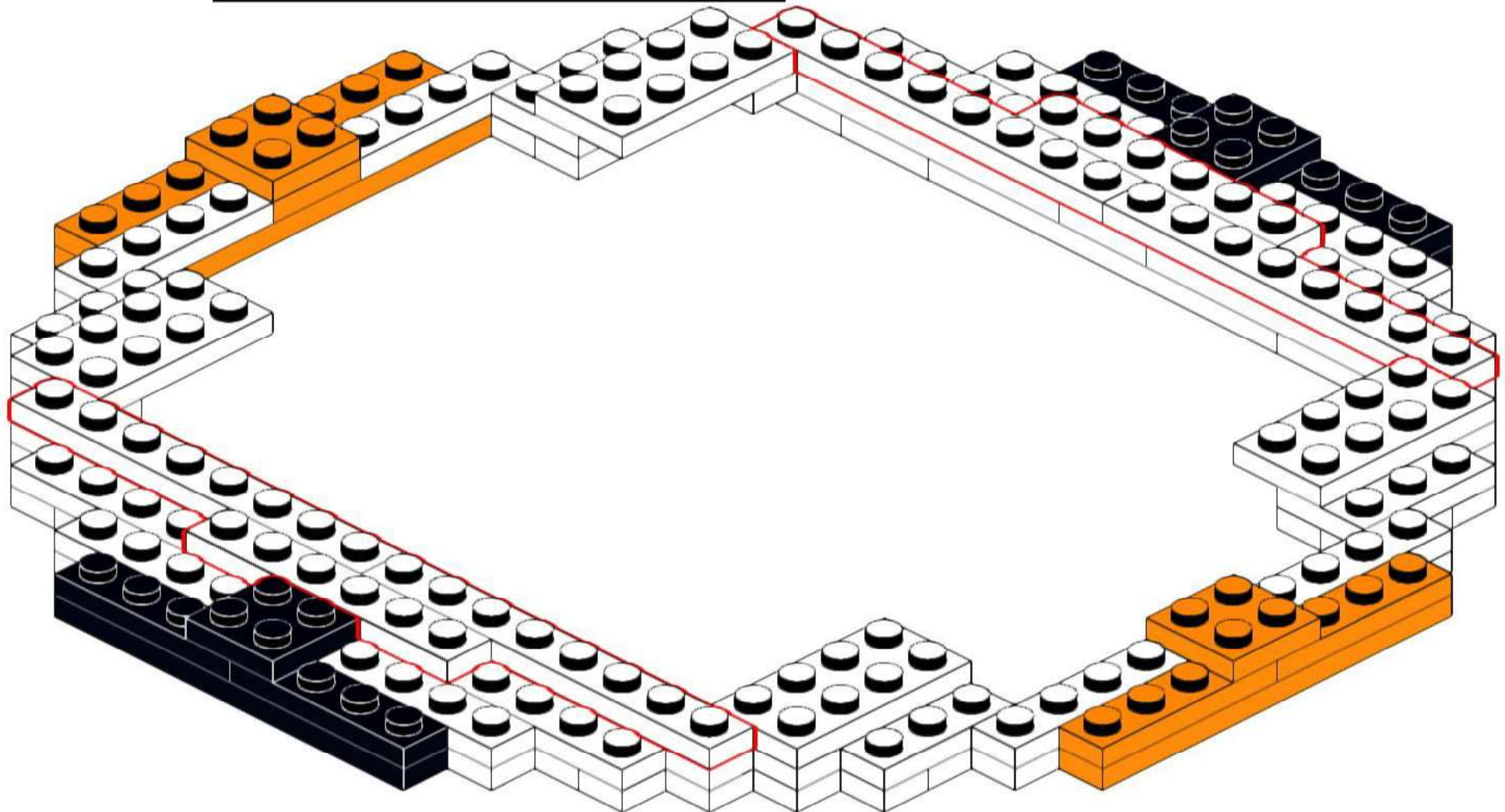
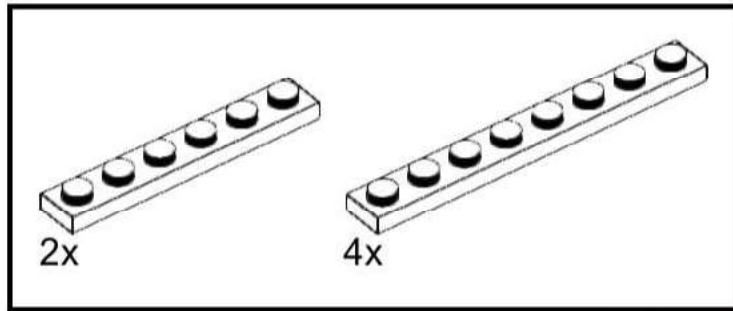

169

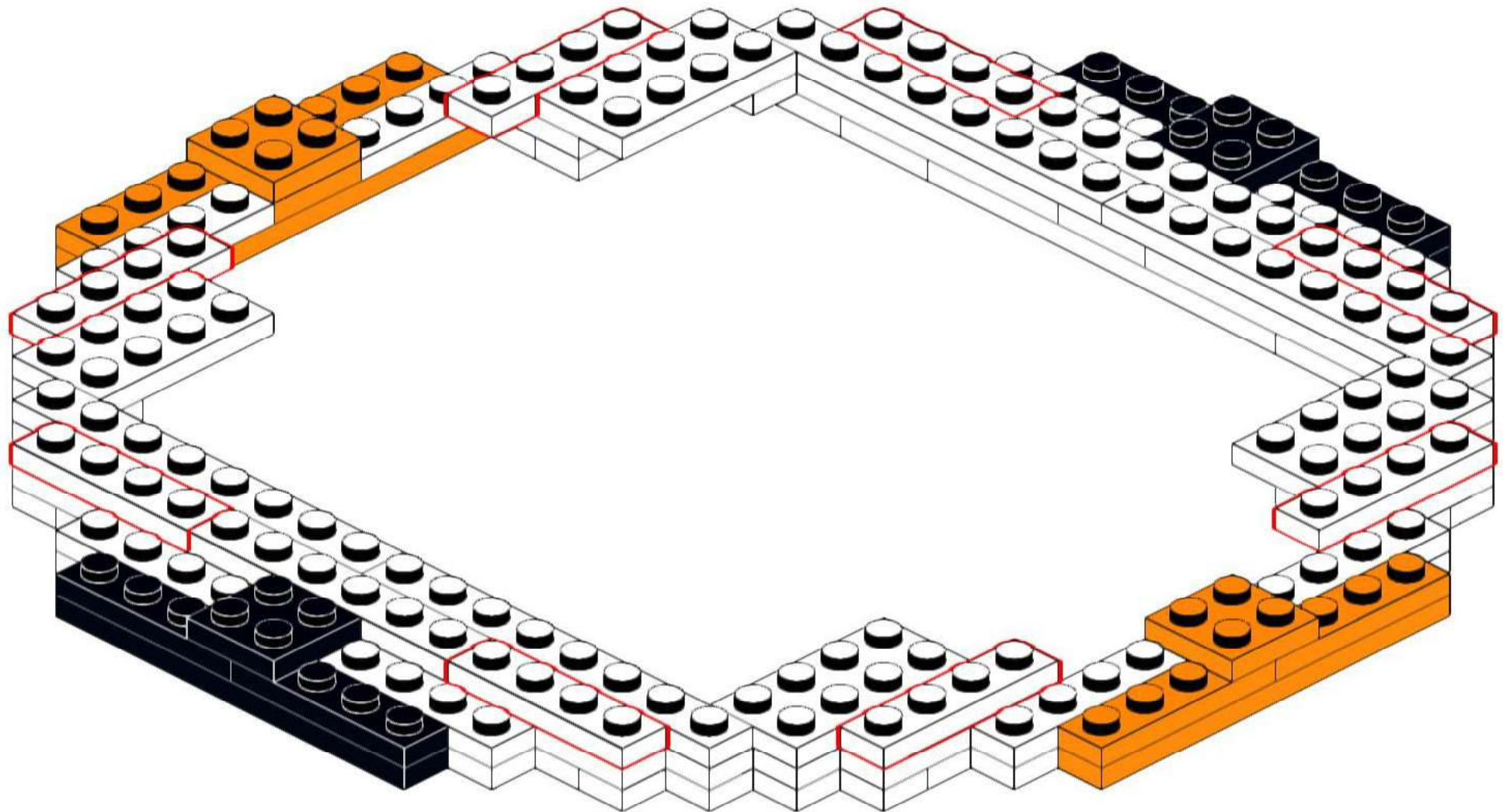
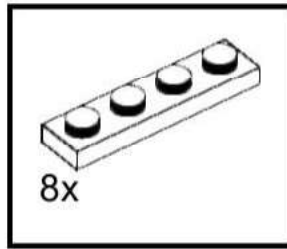

170

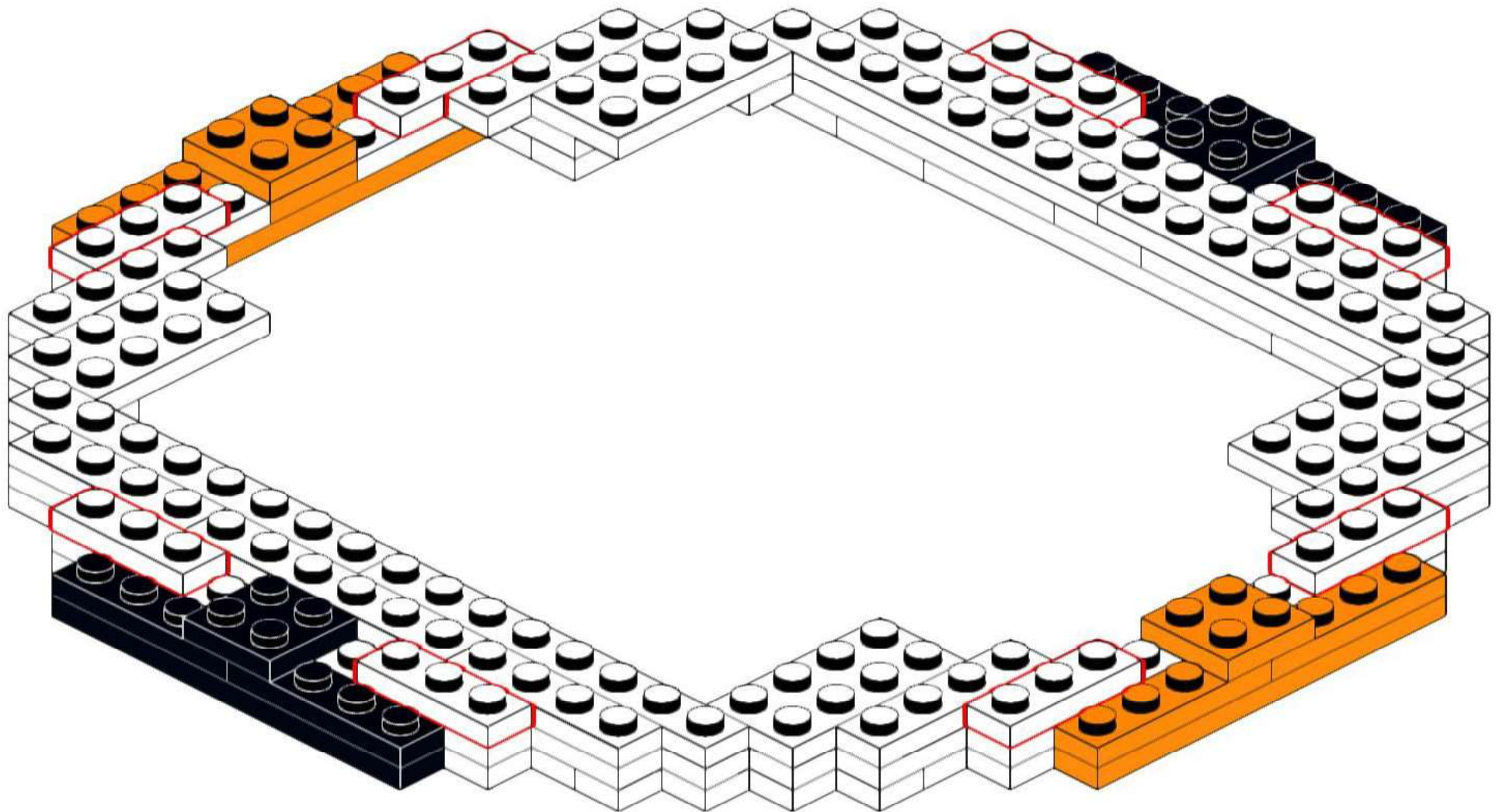
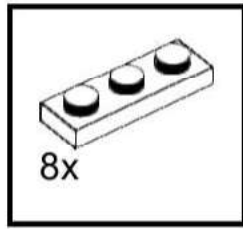

171

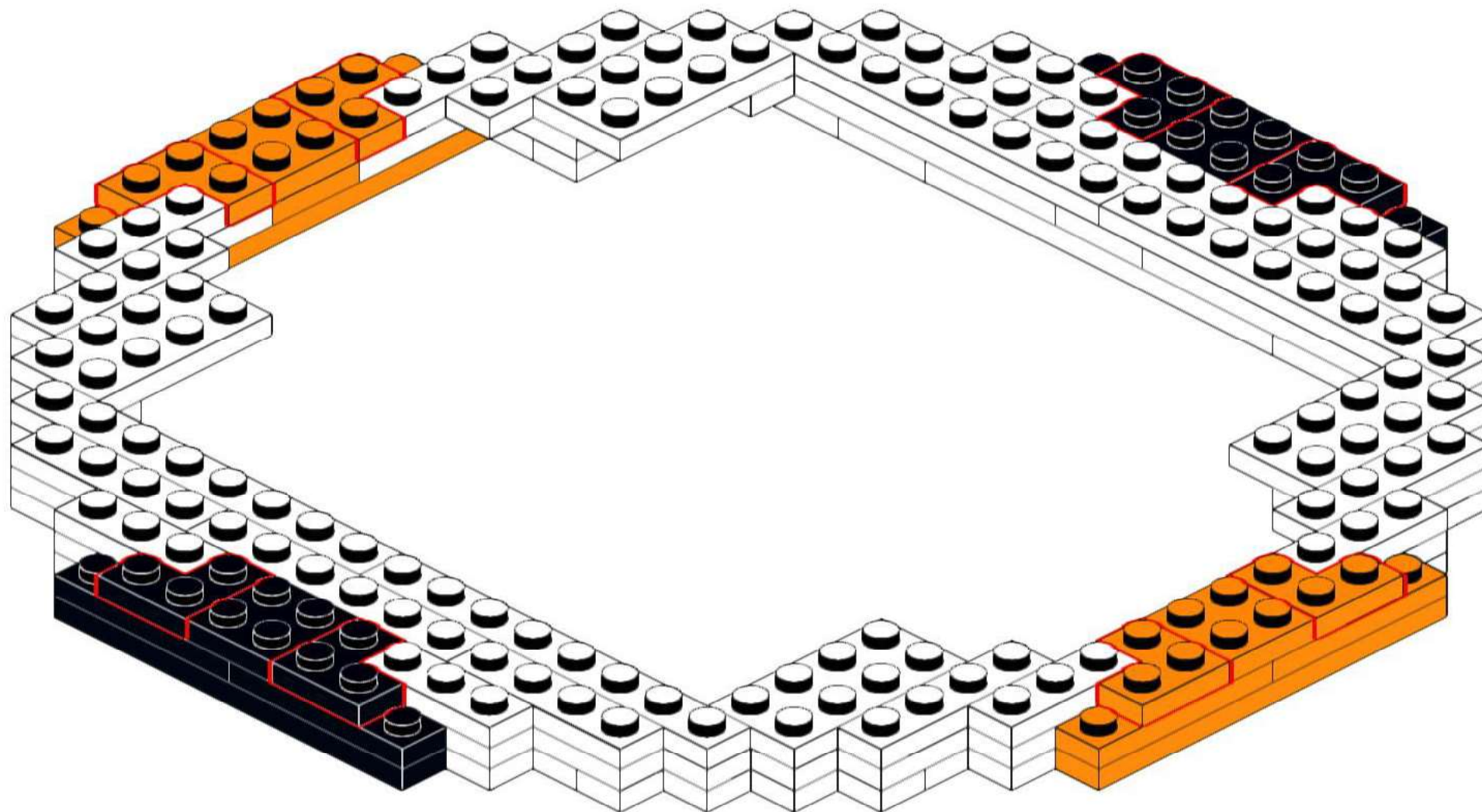
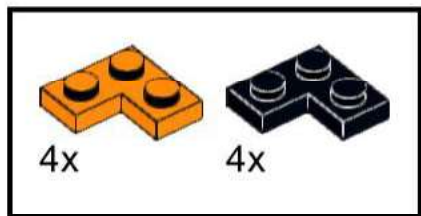

172

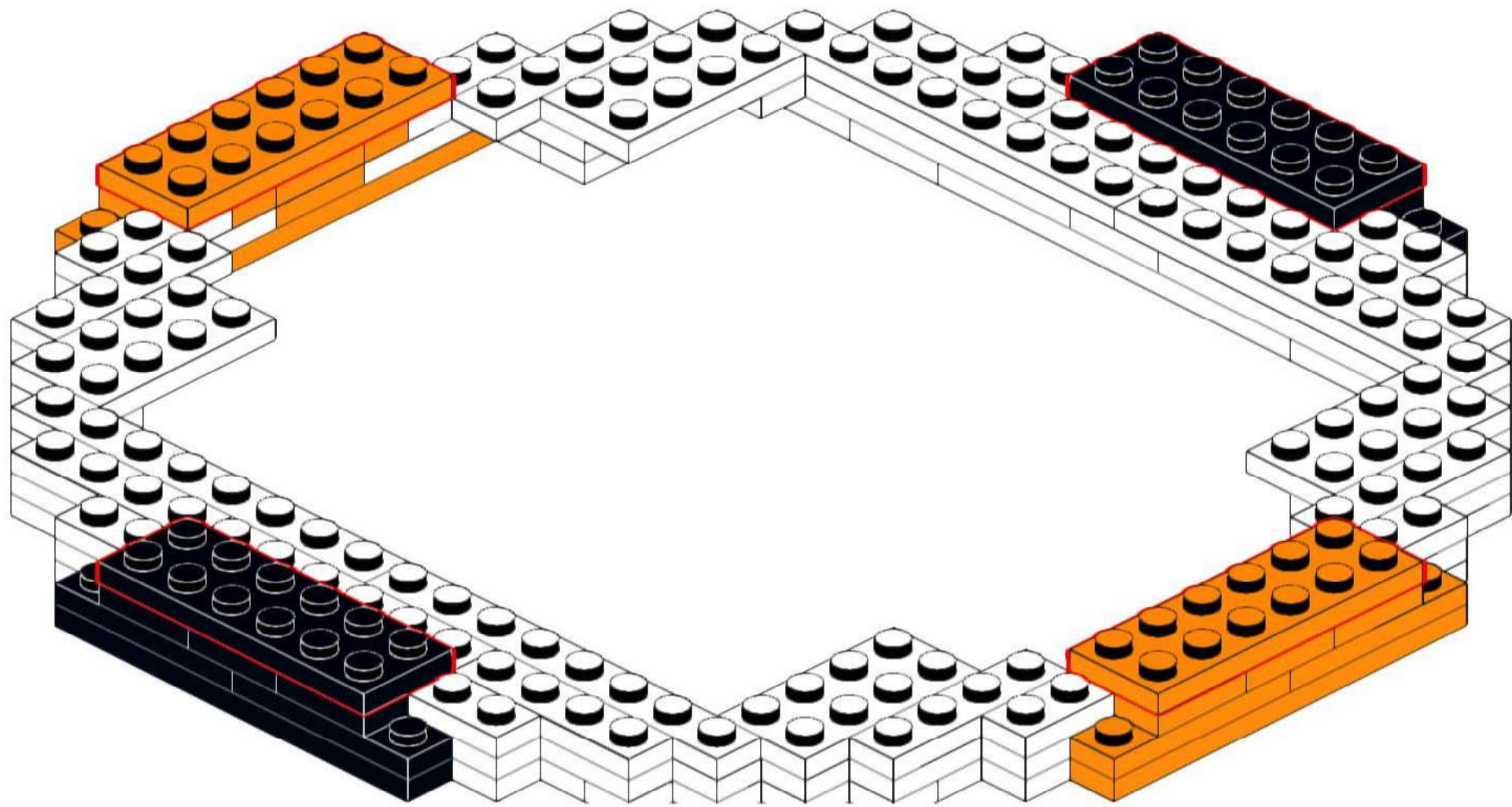
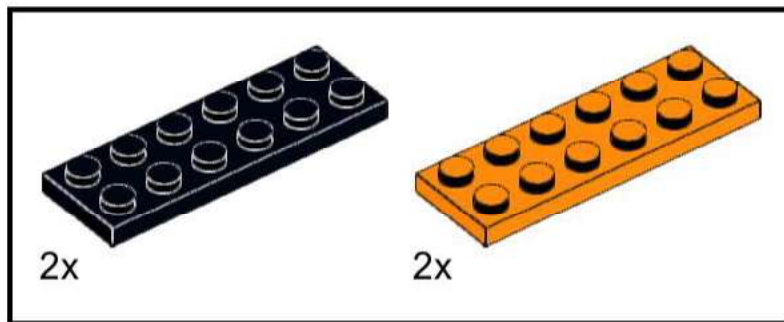

173

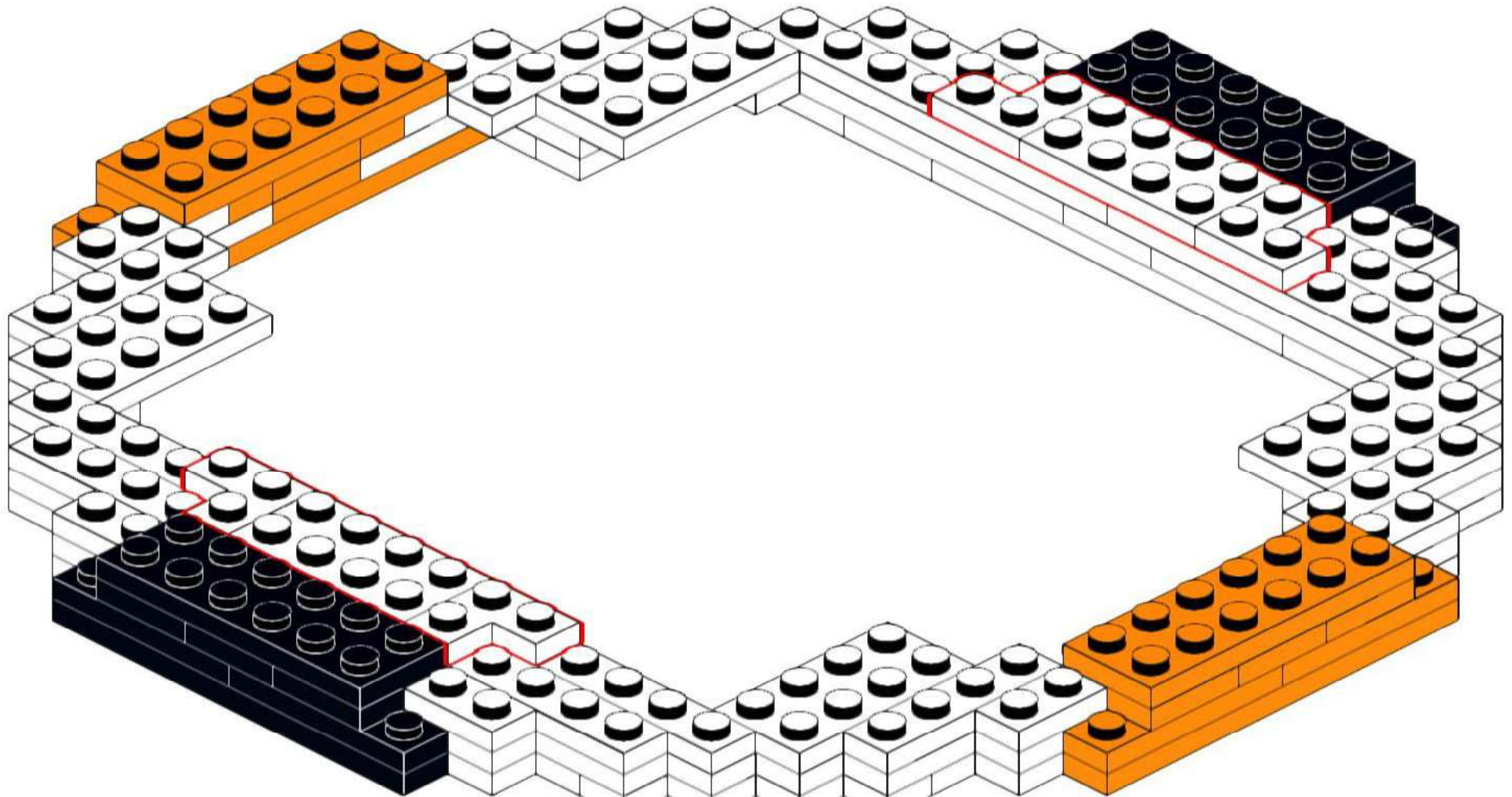
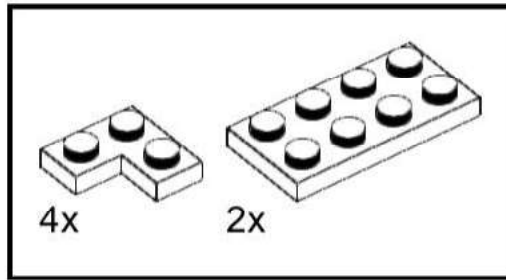

174

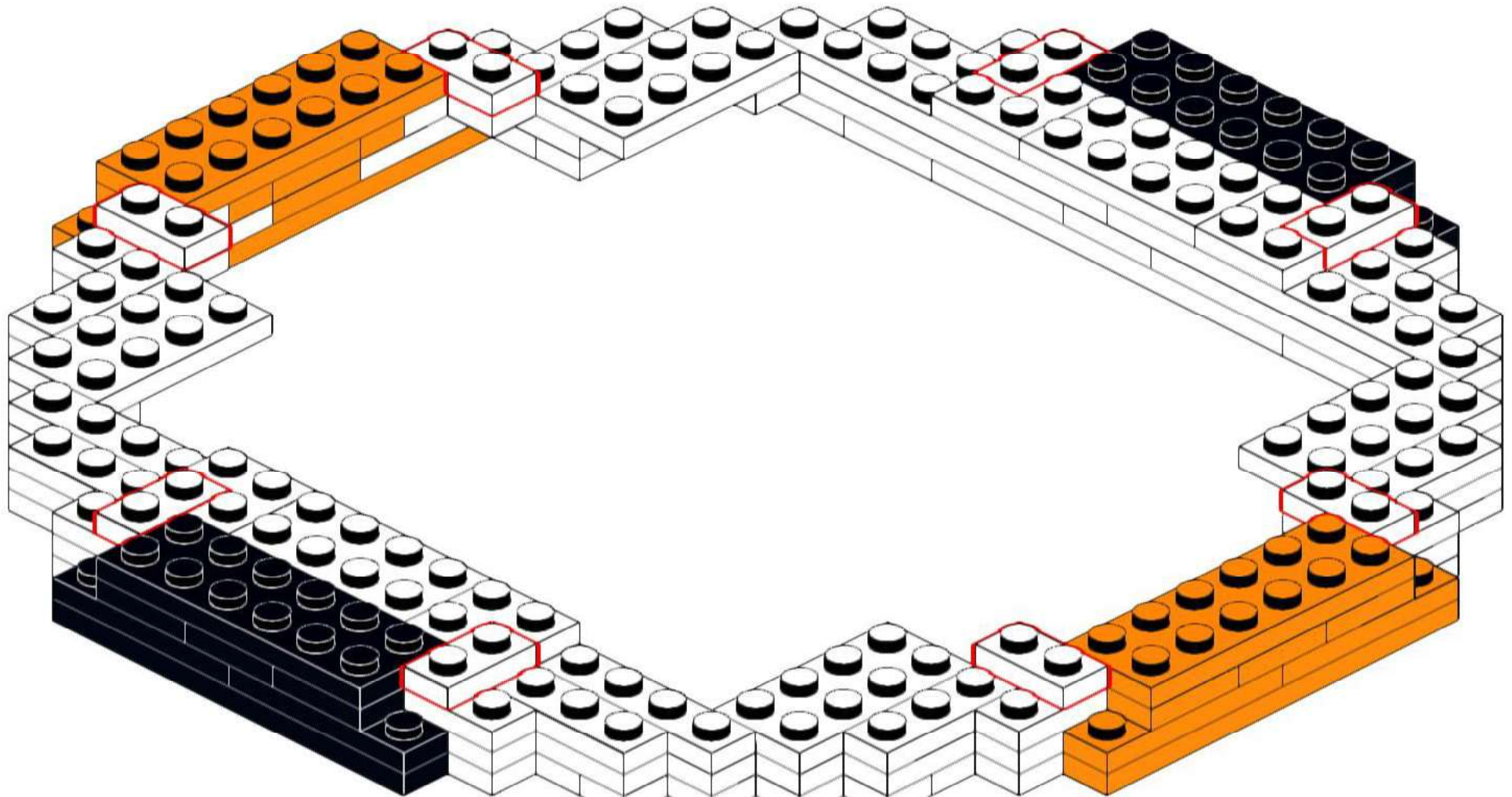
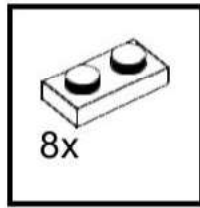

175

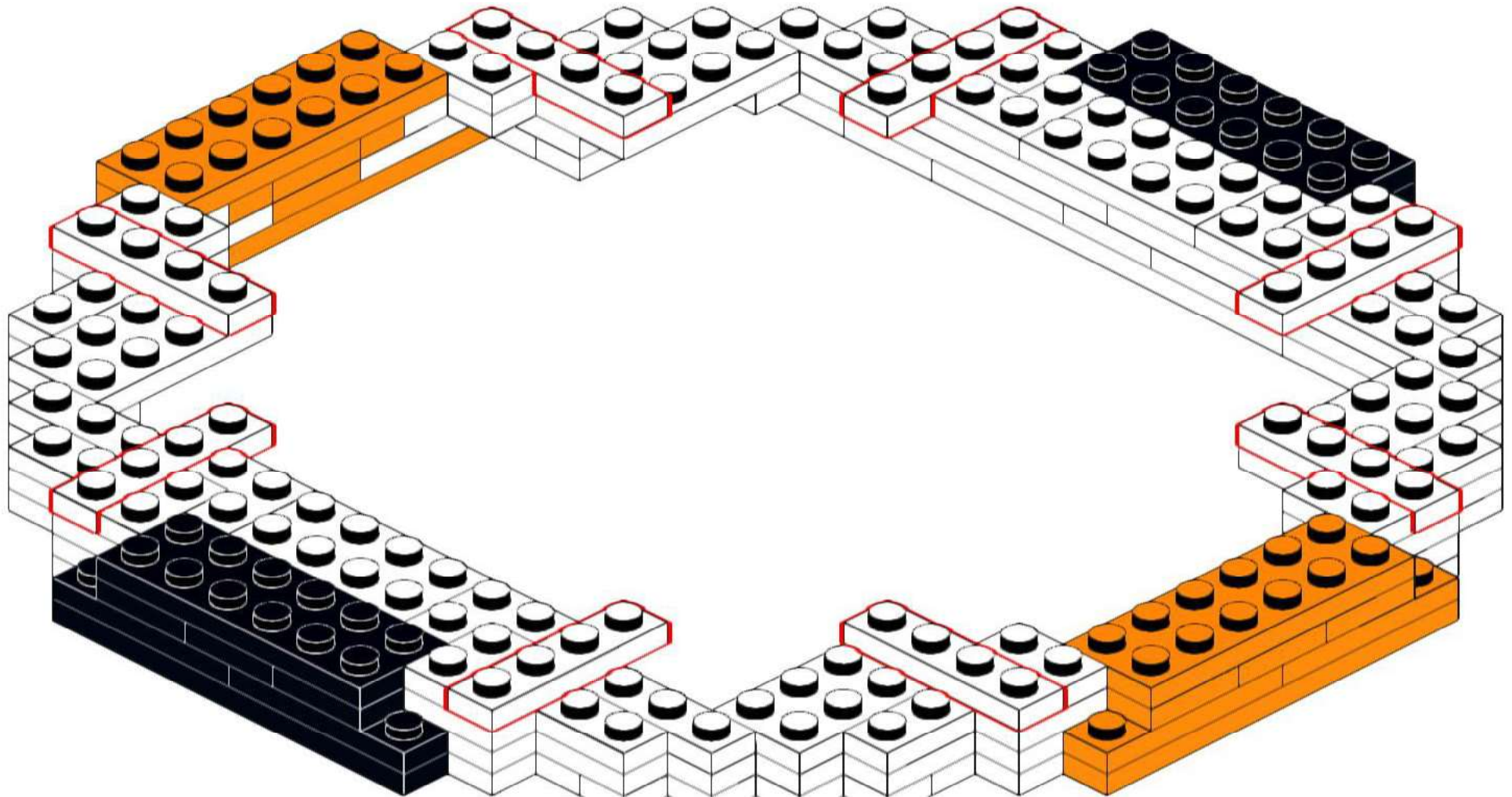
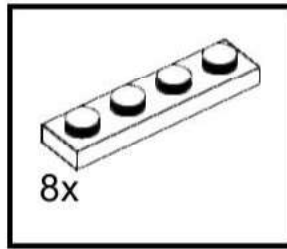

176

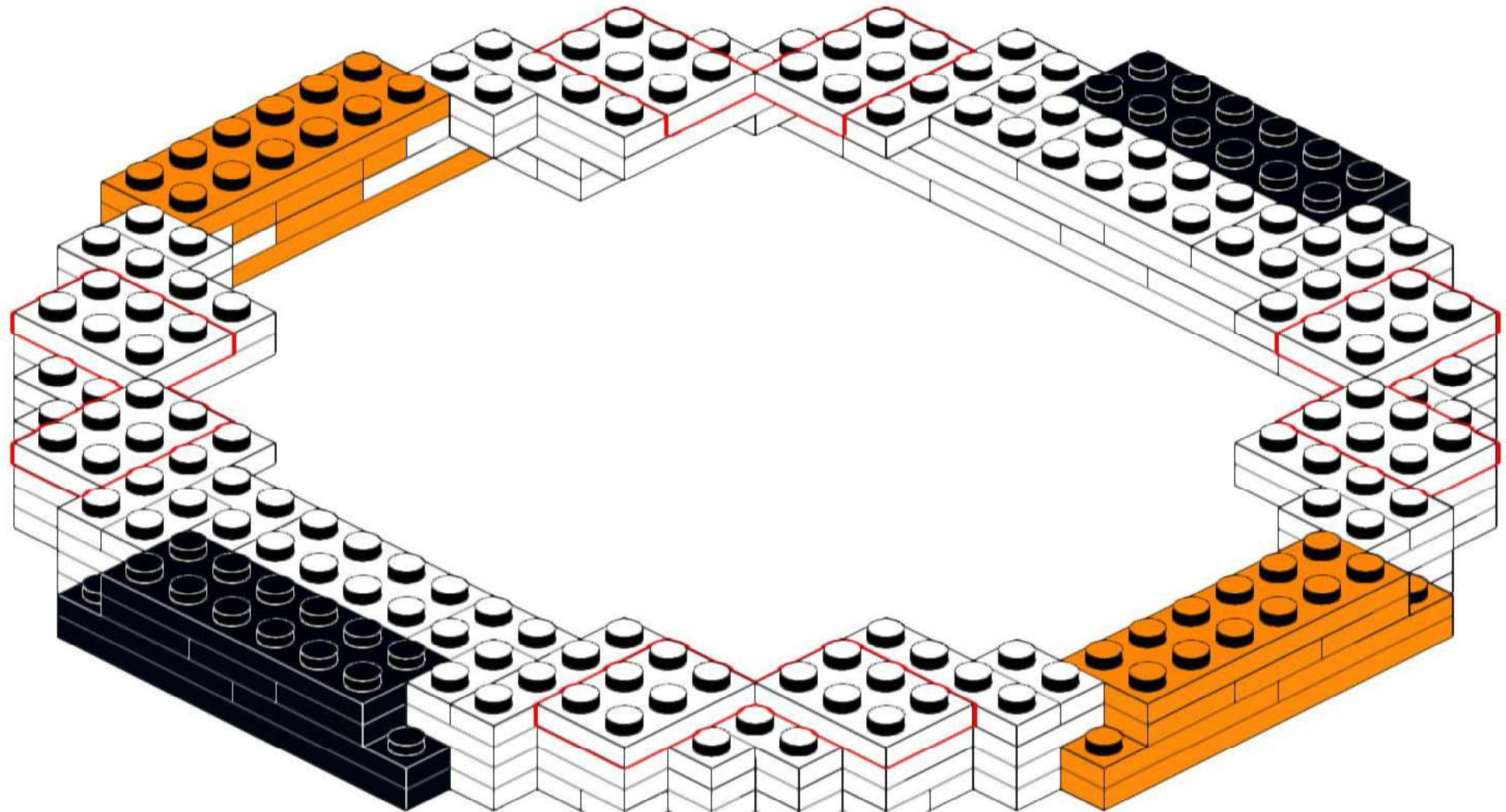
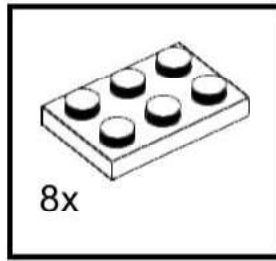

177

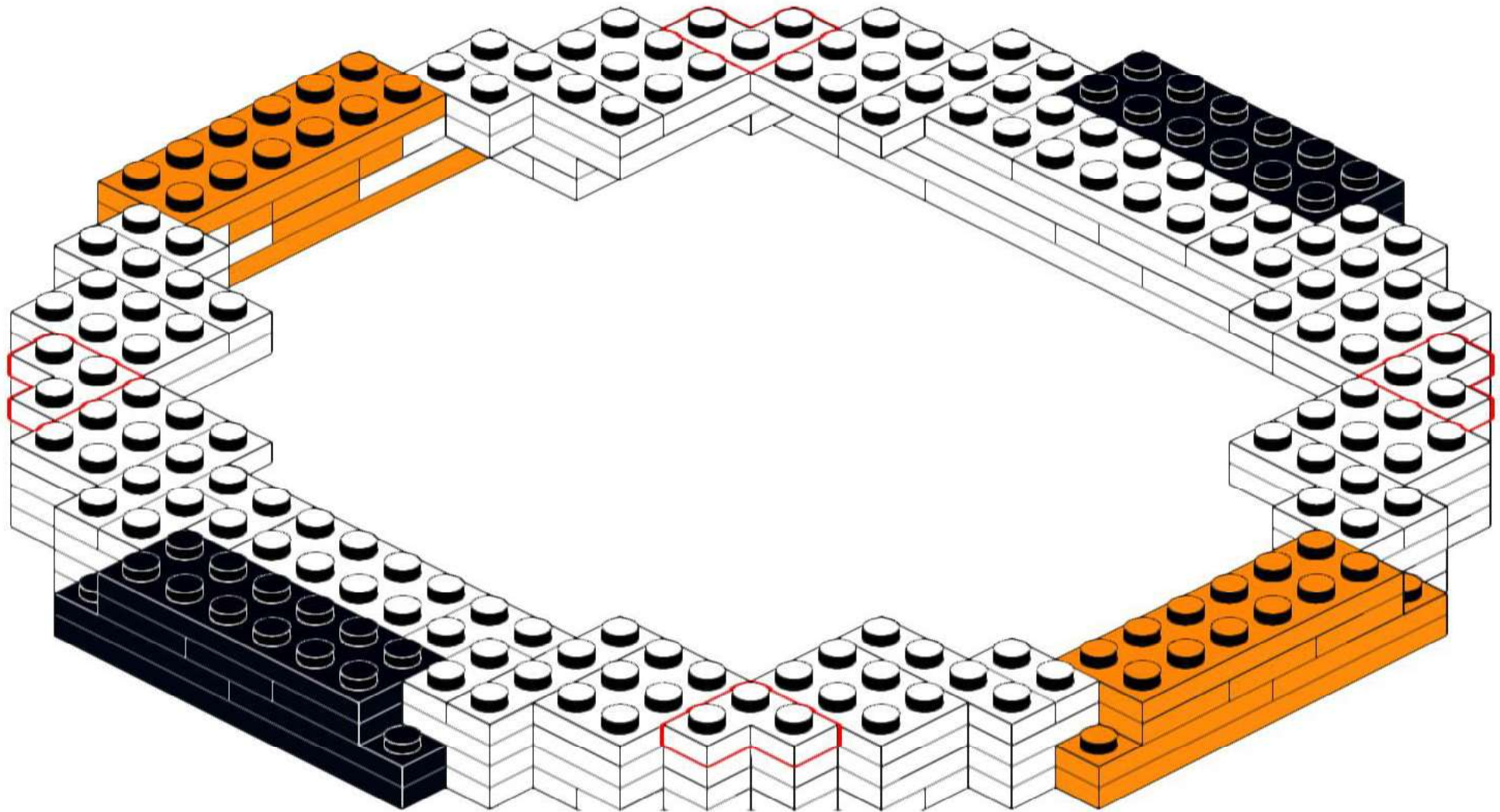
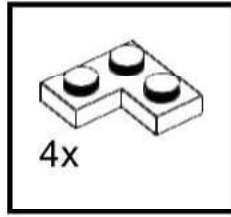

178

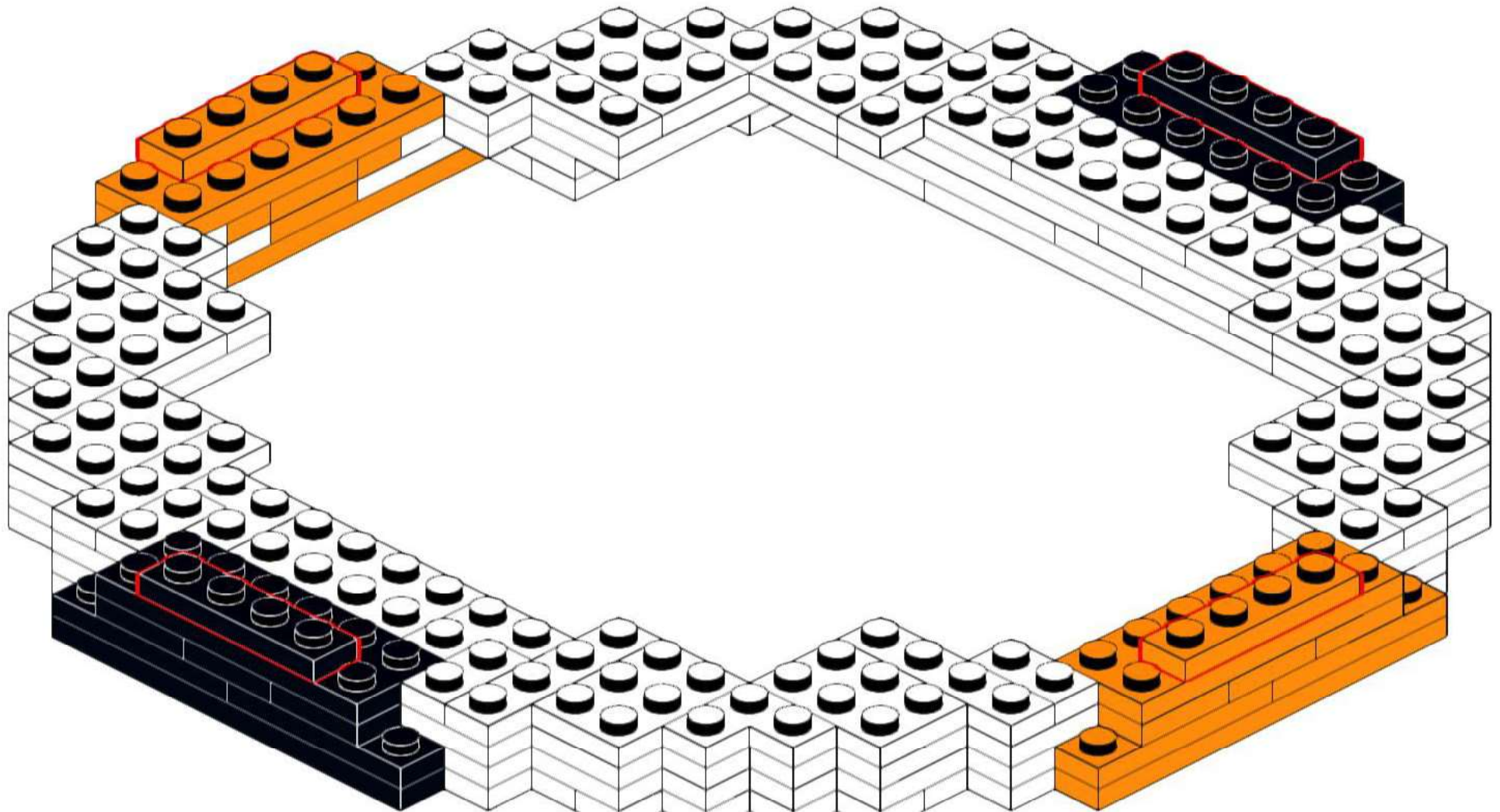
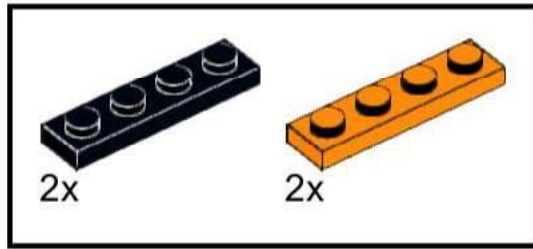

179

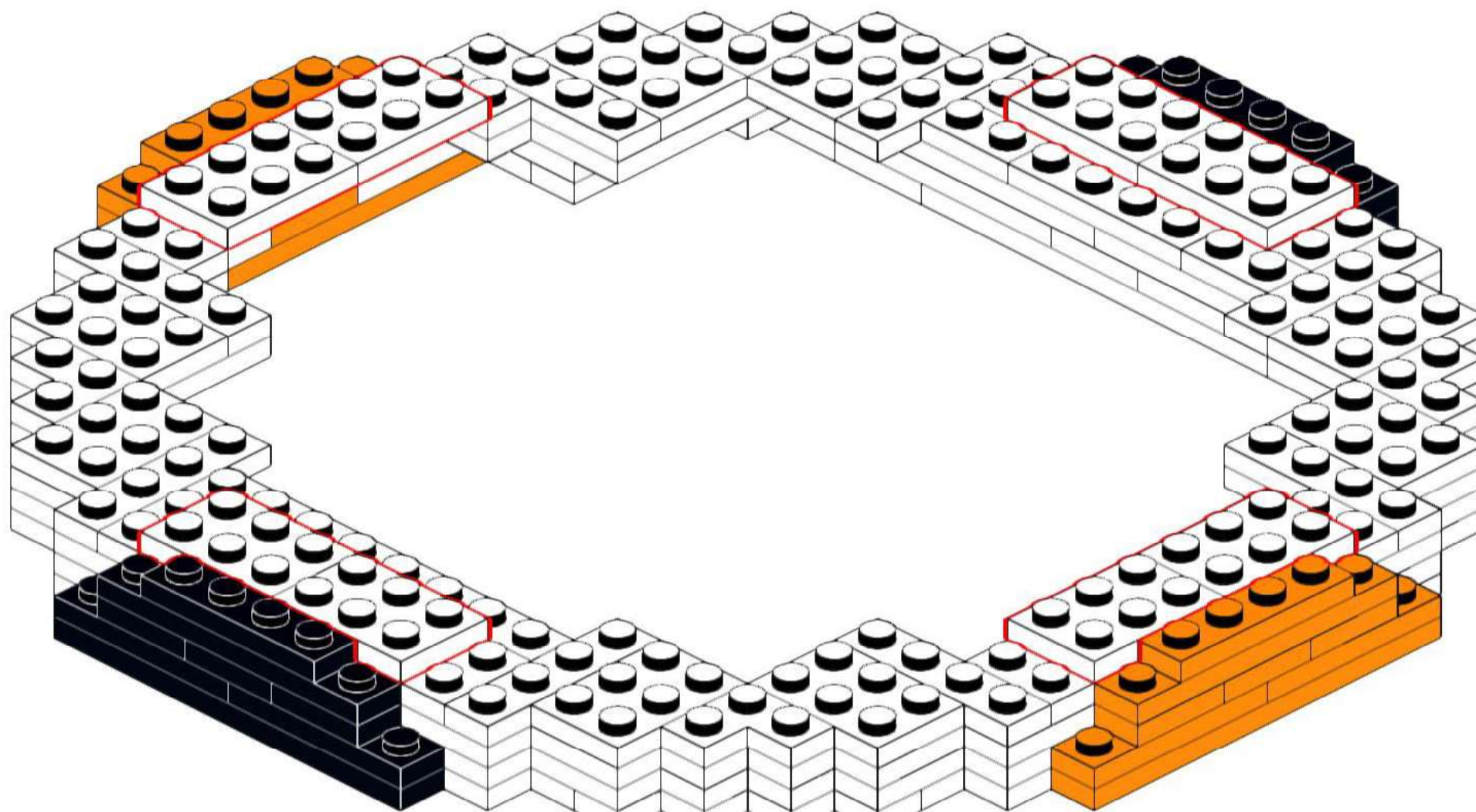
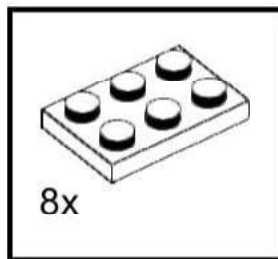

180

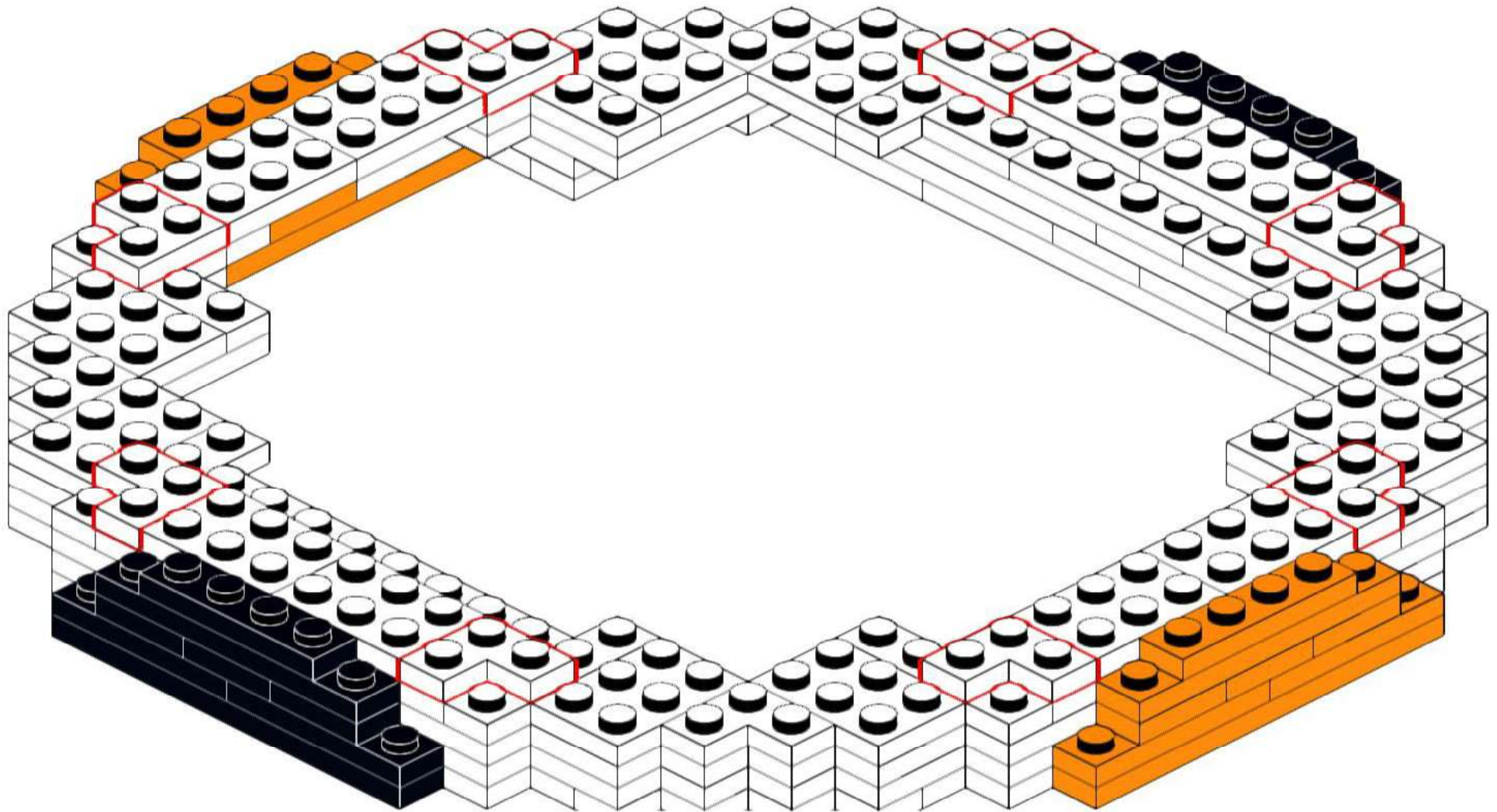
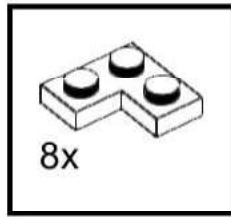

181

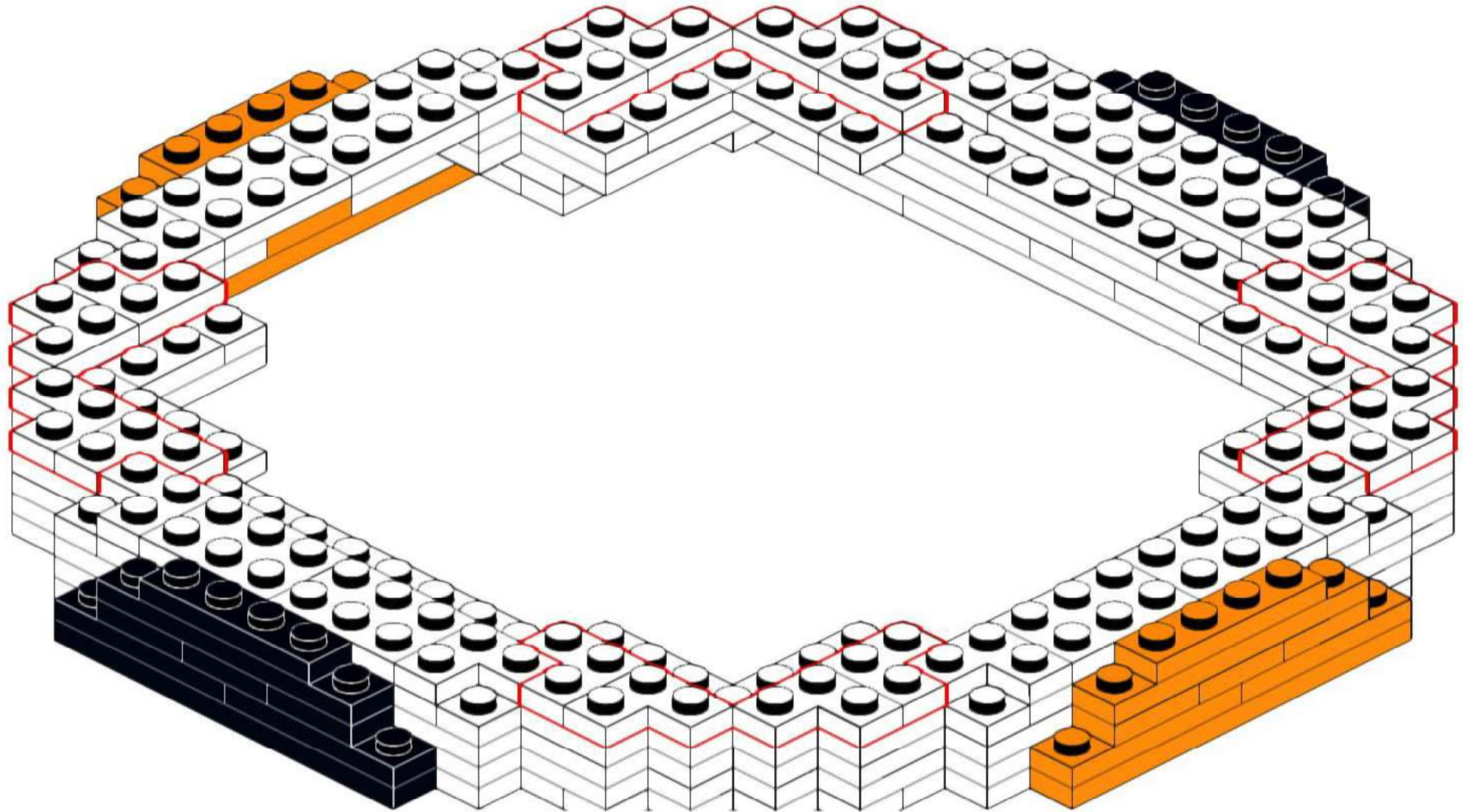
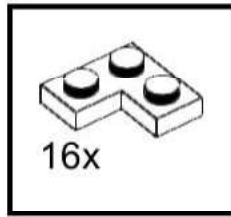

182

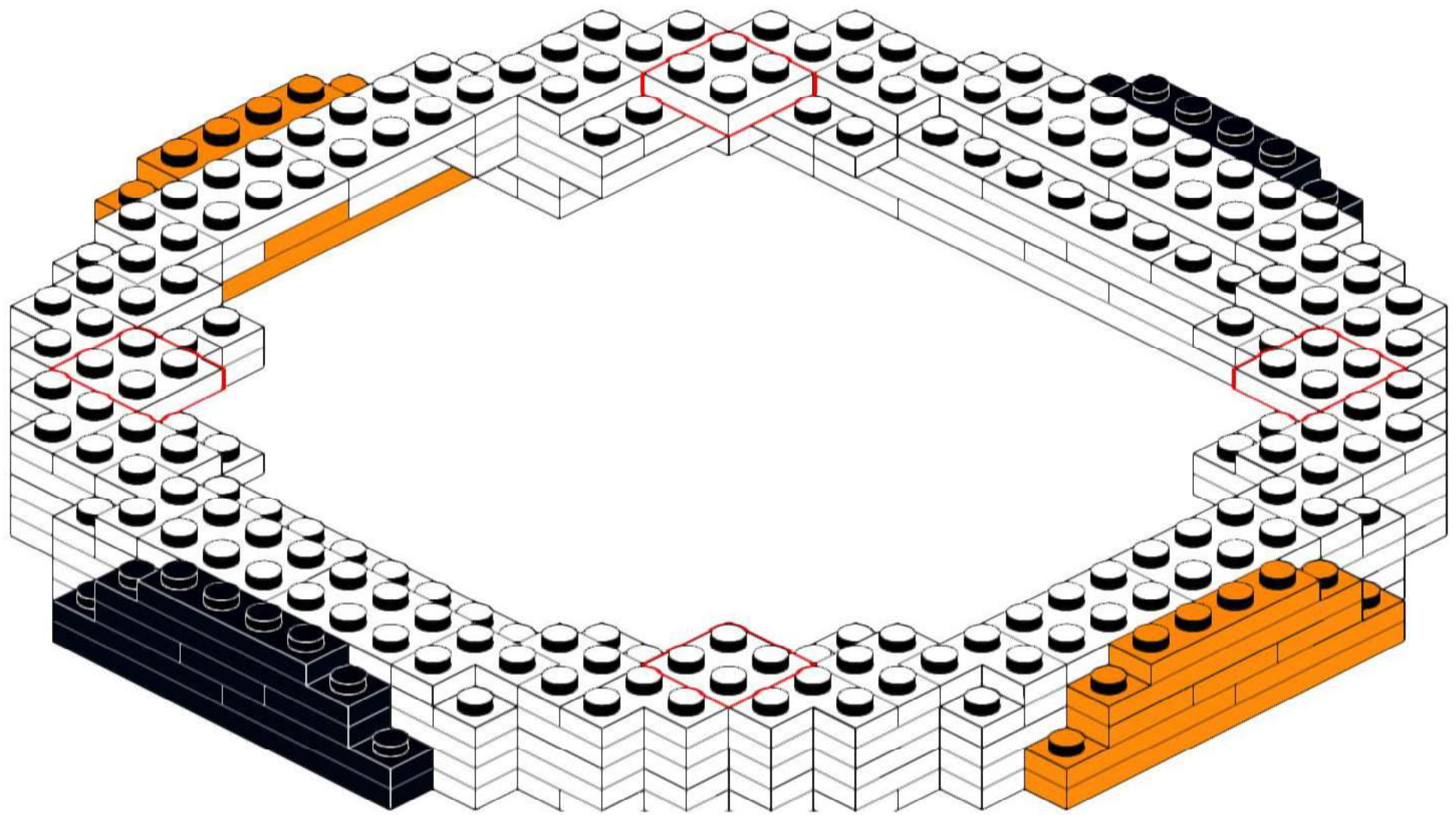
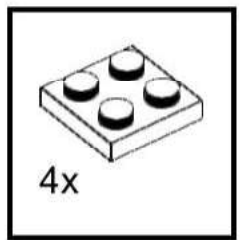

183

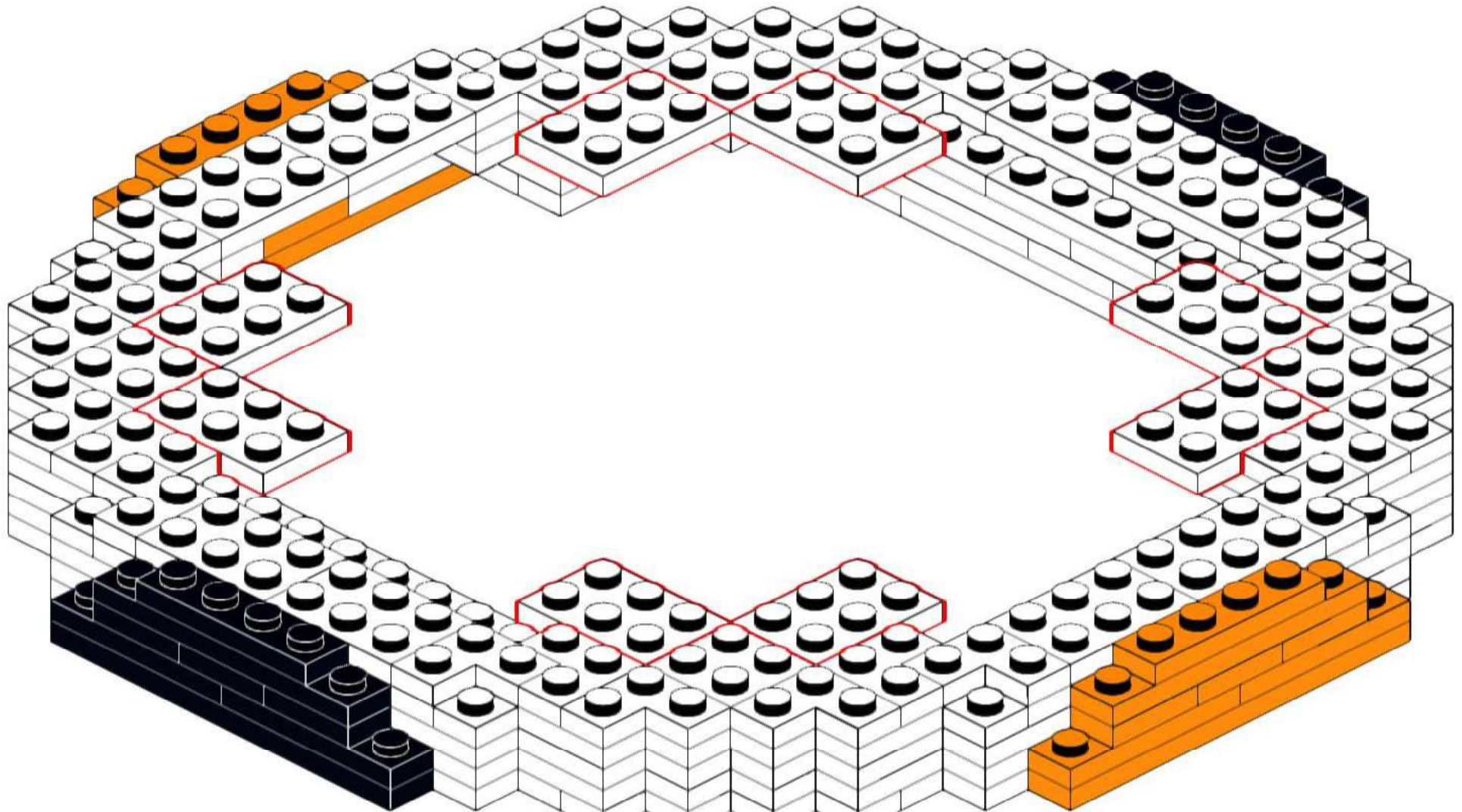
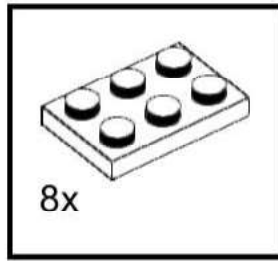

184

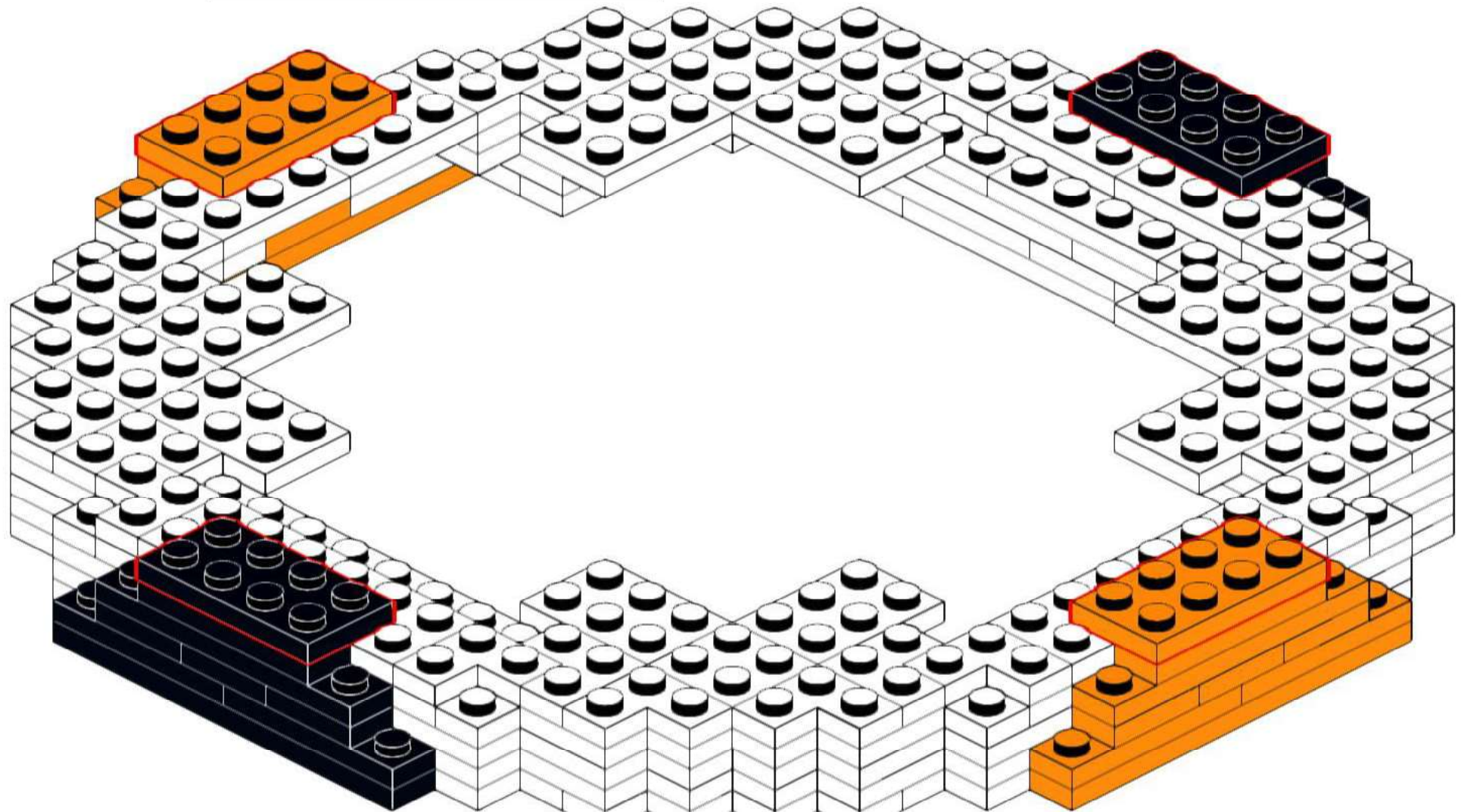
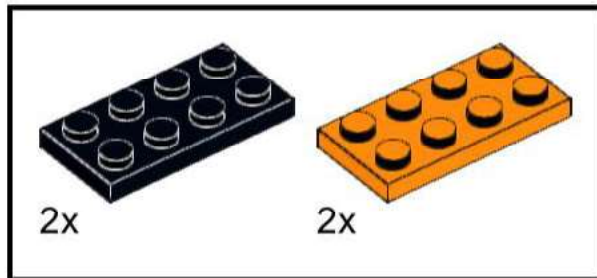

185

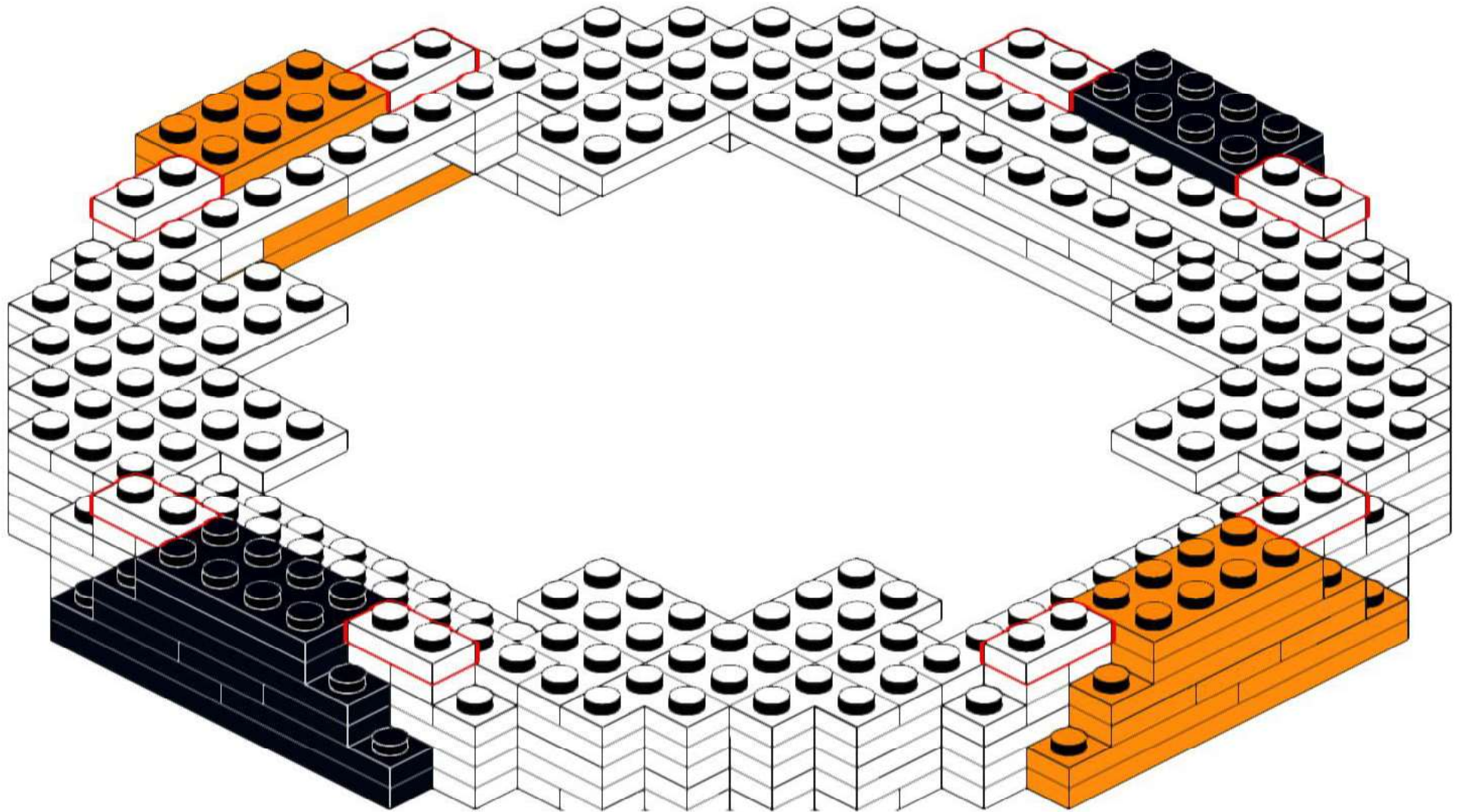
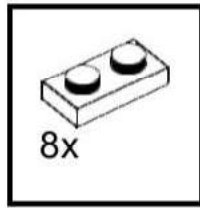

186

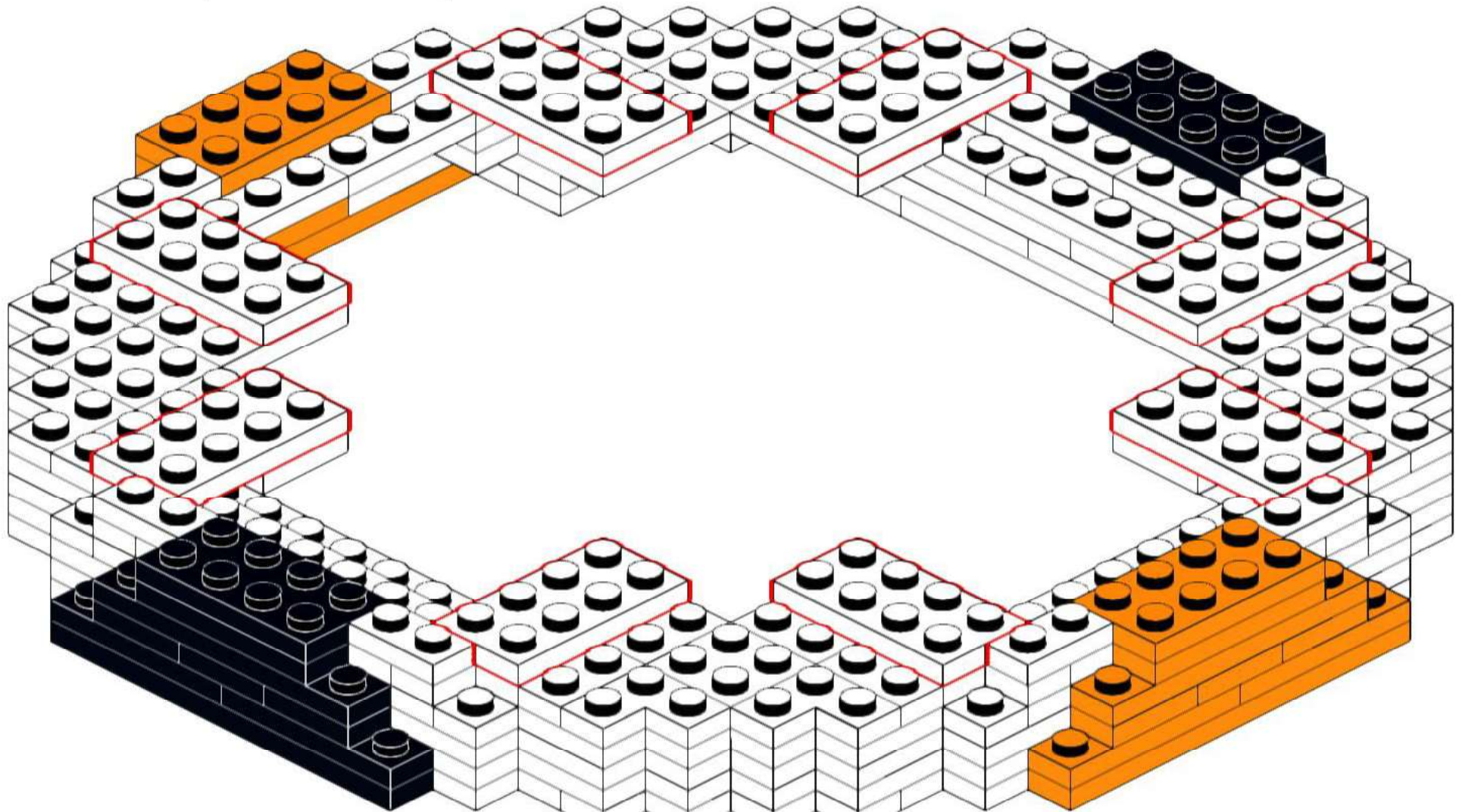
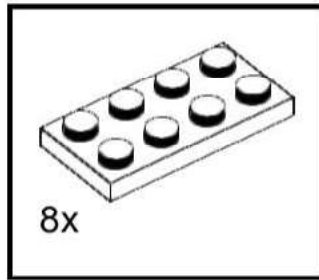

187

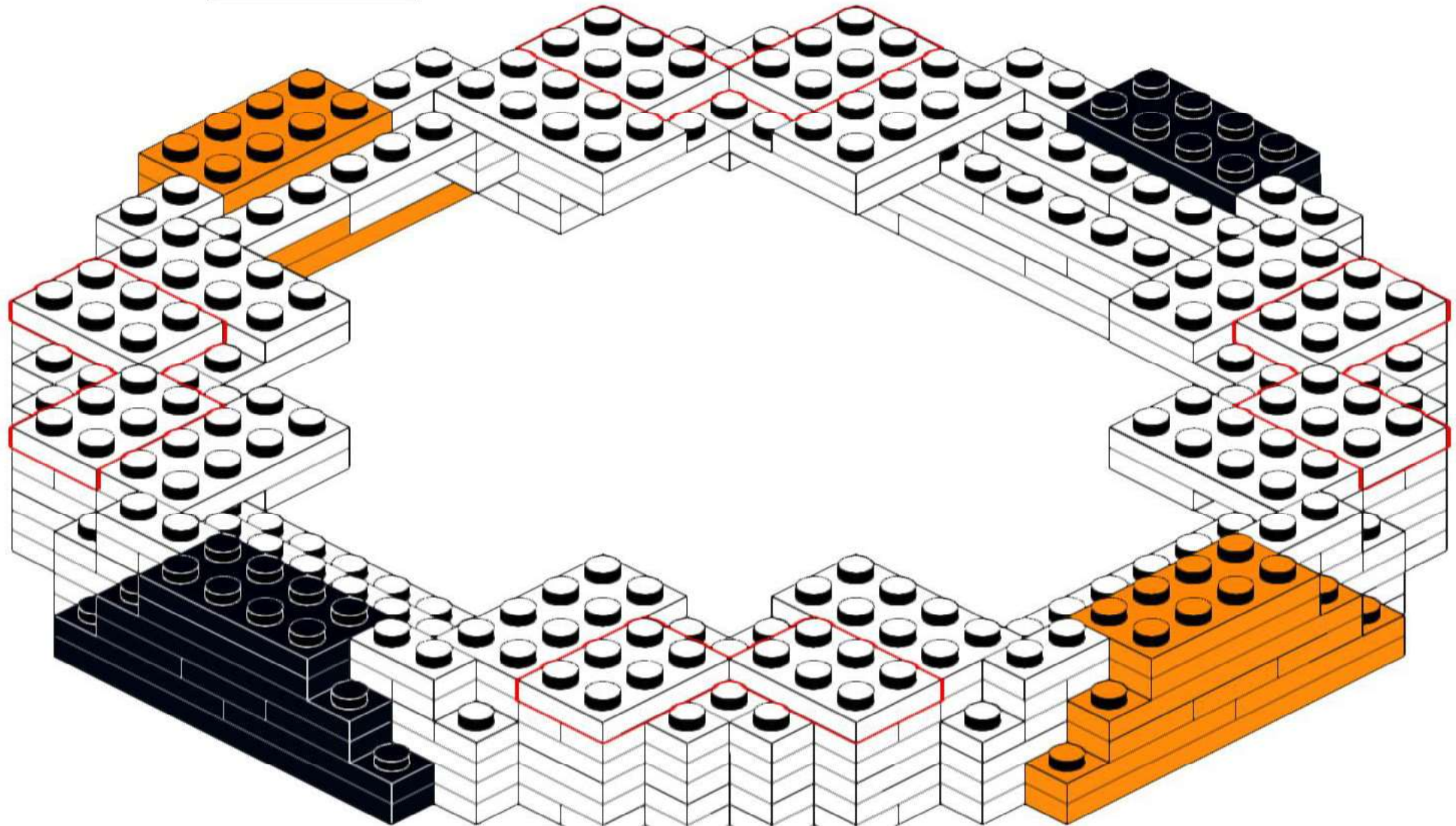
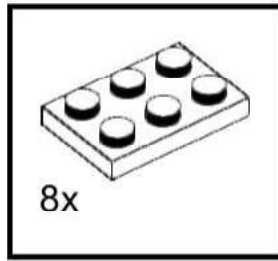

188

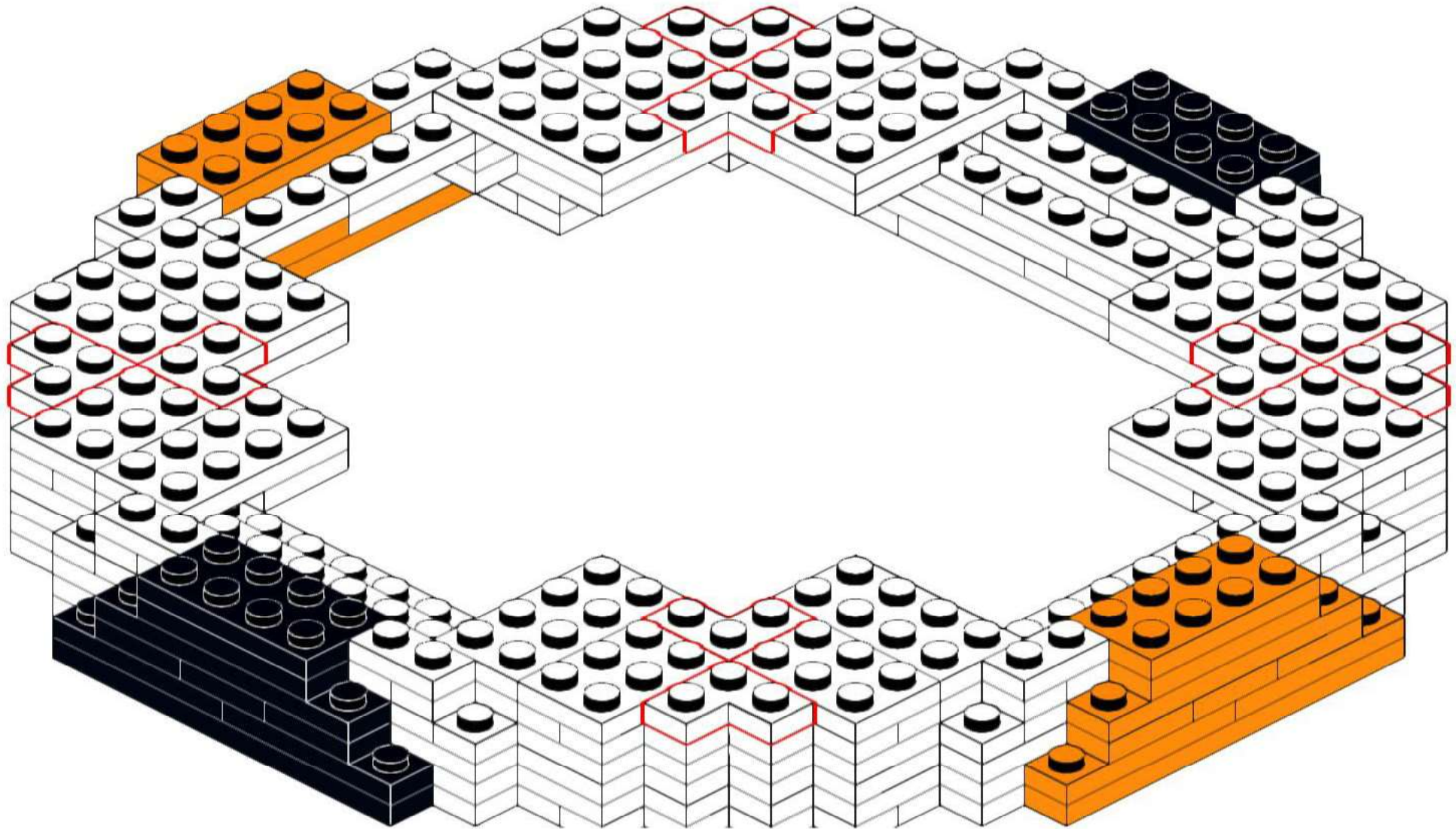
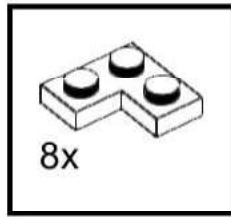

189

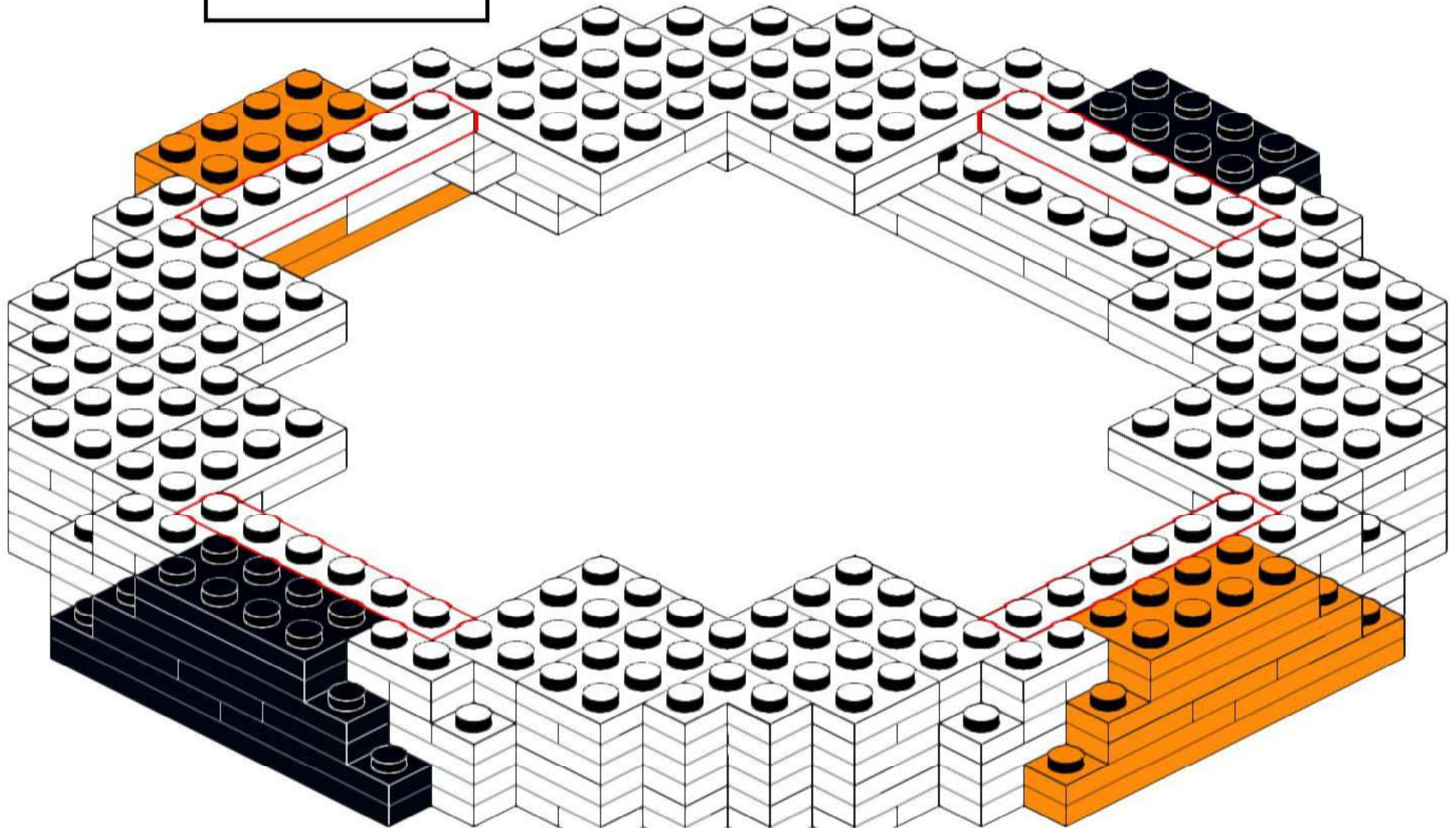
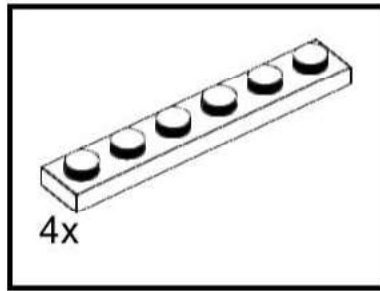

190

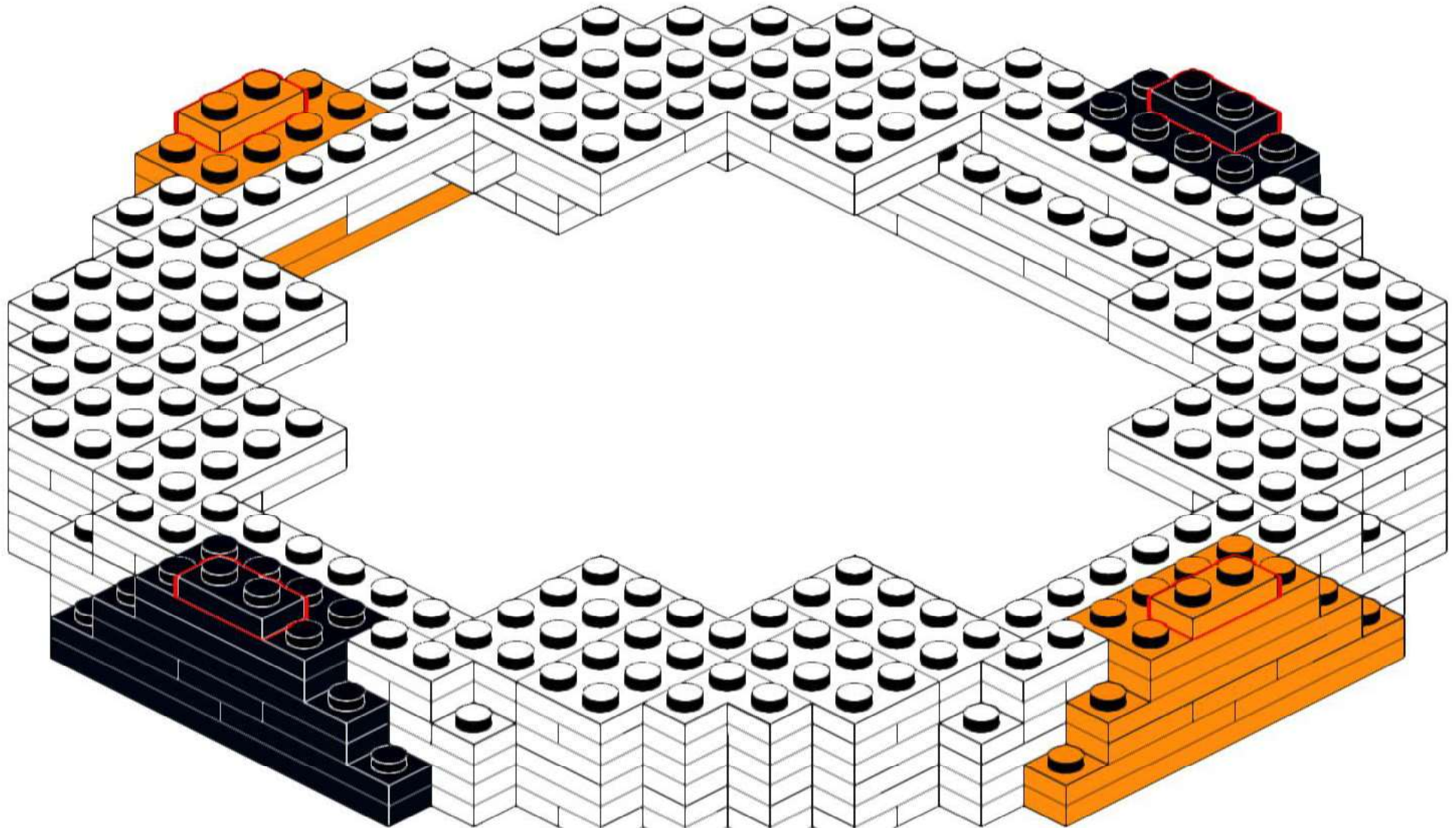
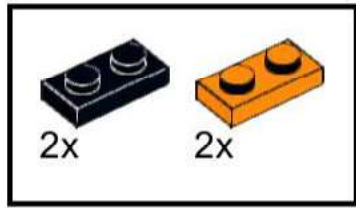

191

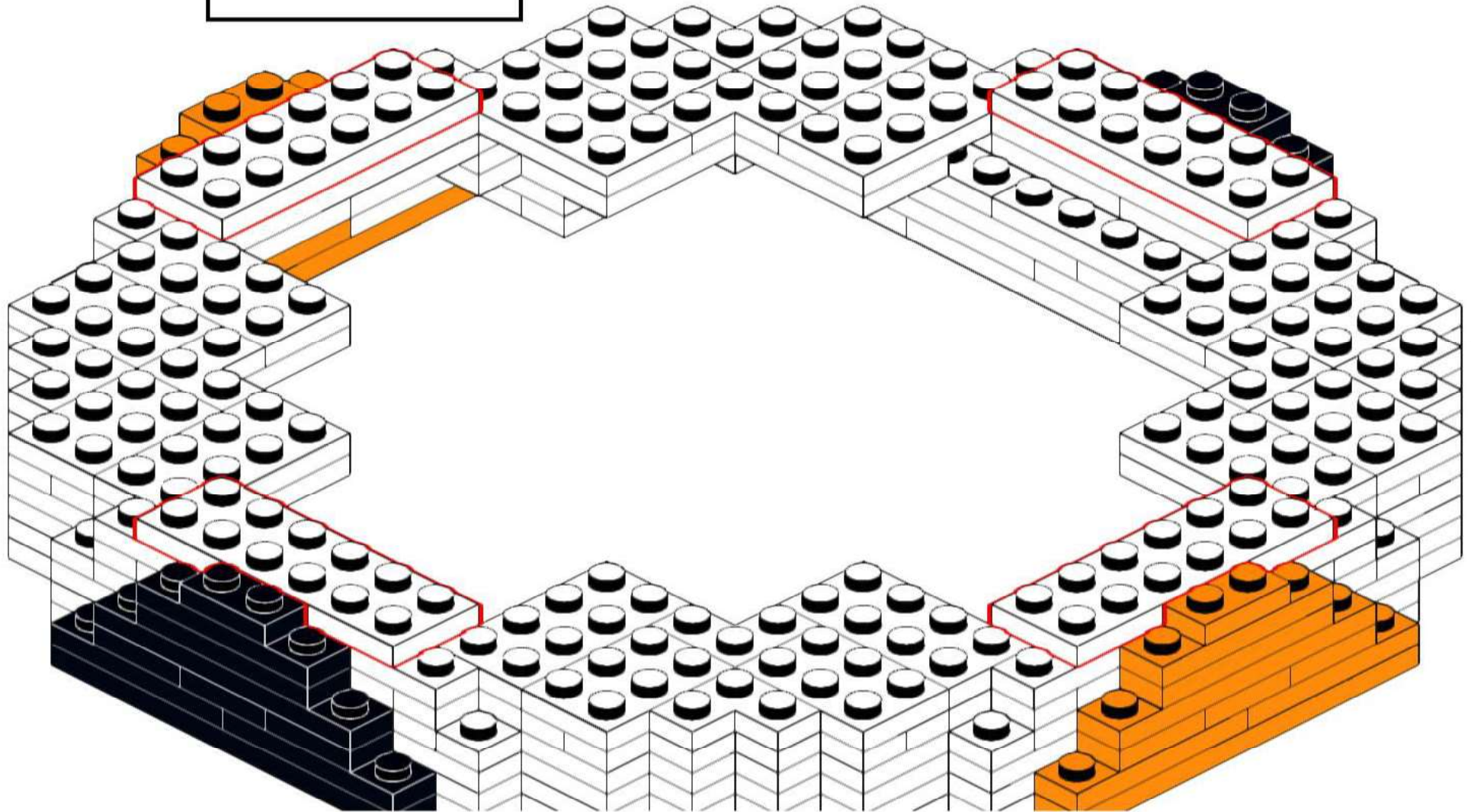
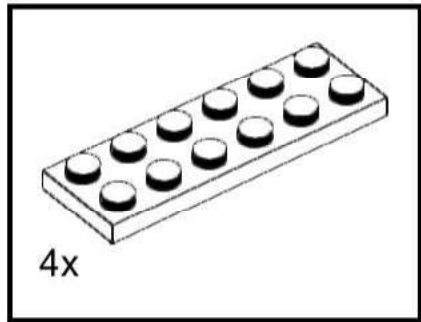

192

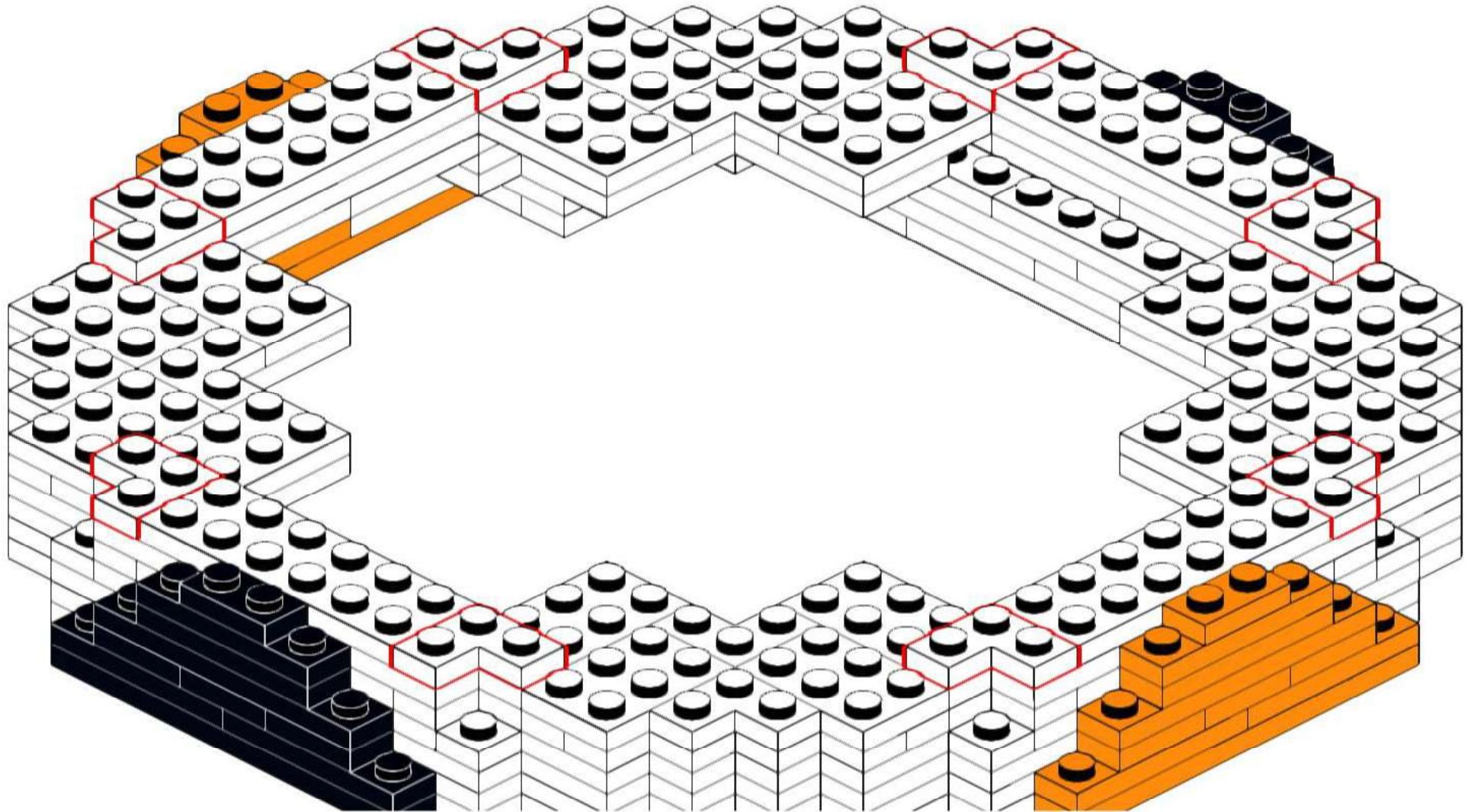
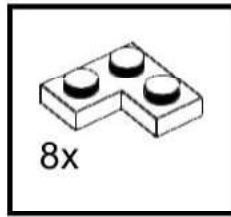

193

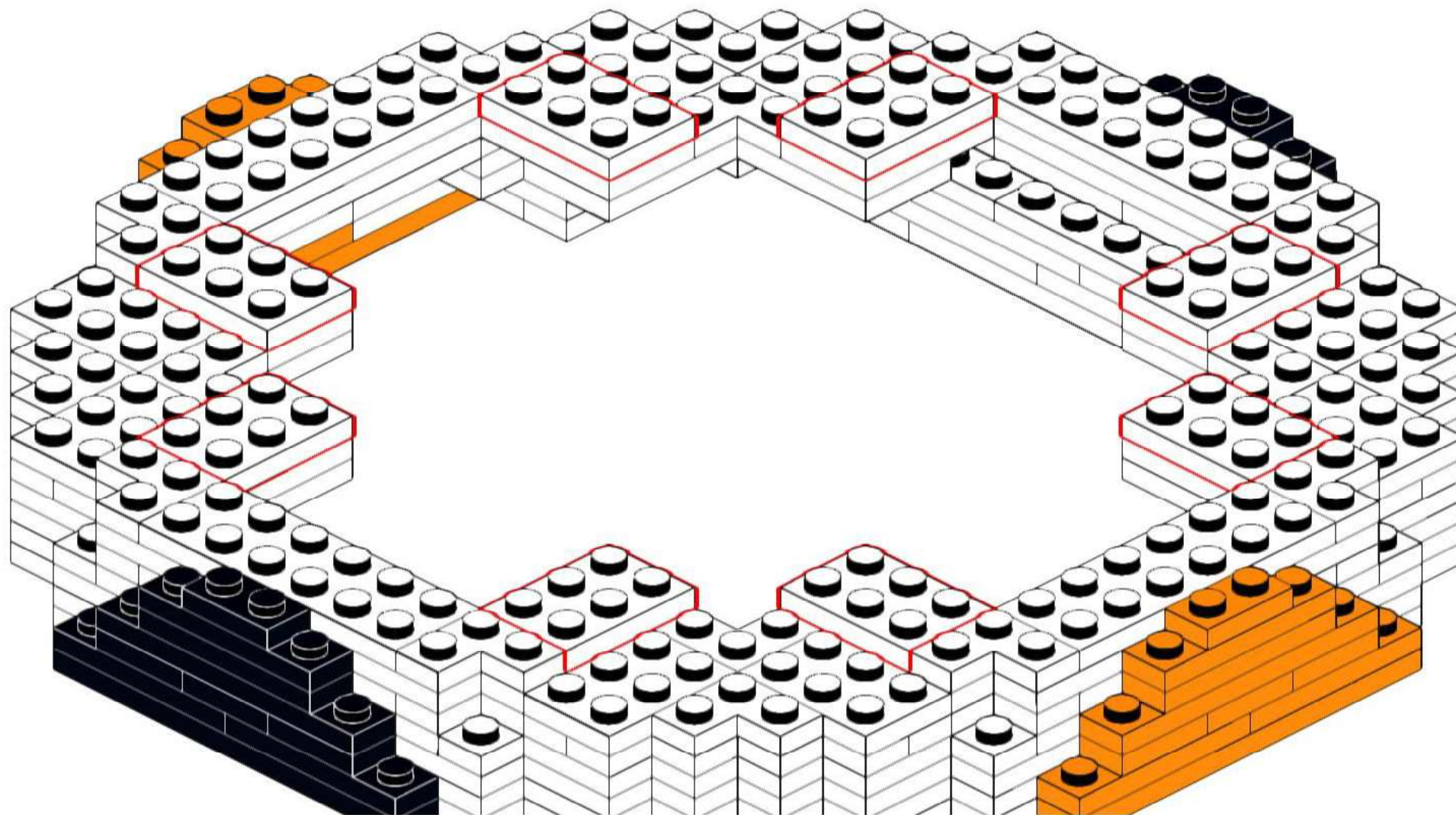
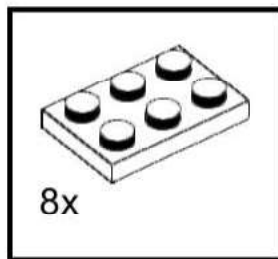

194

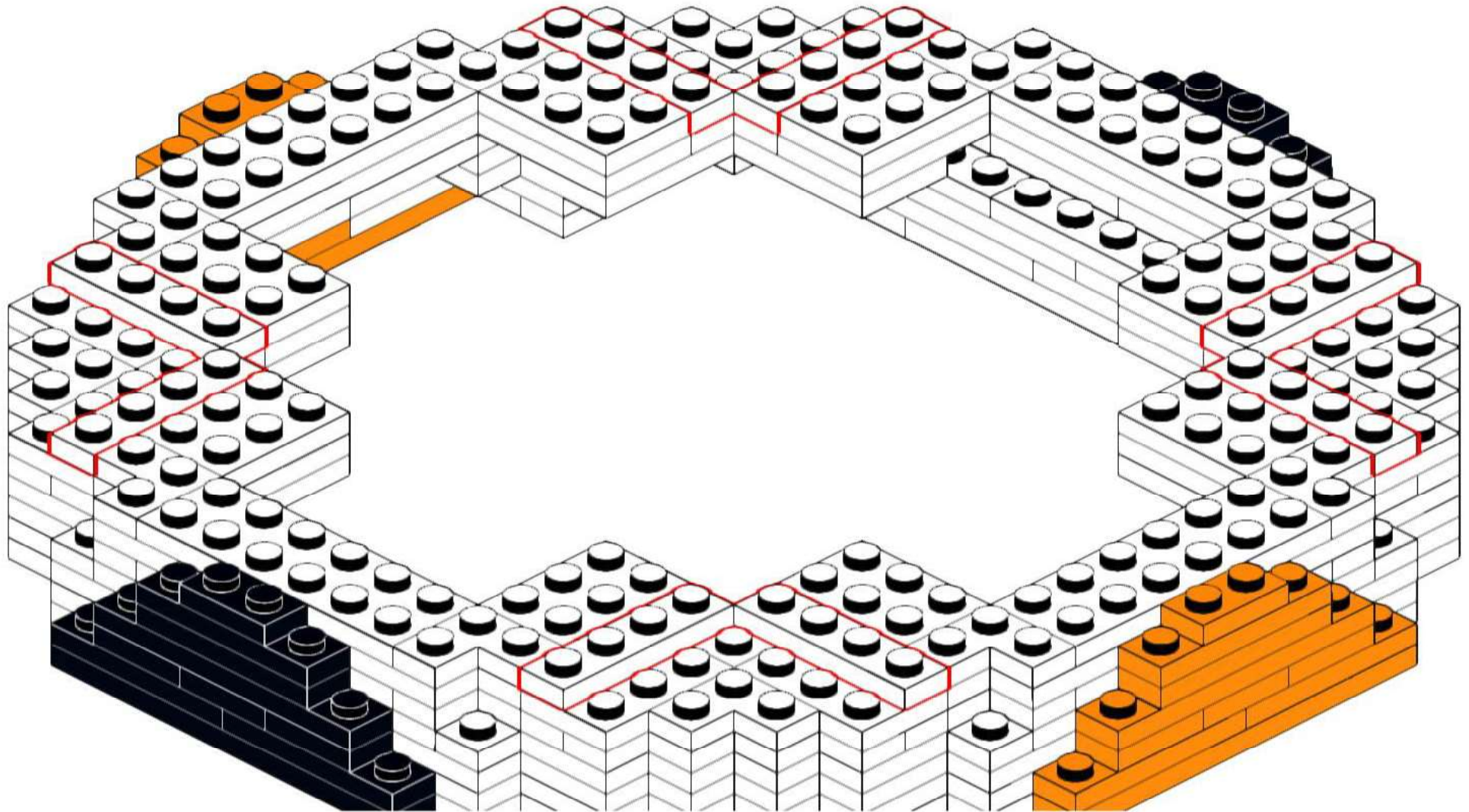
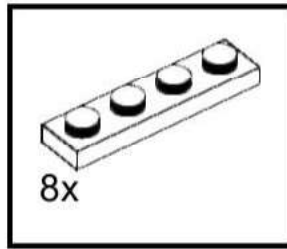

195

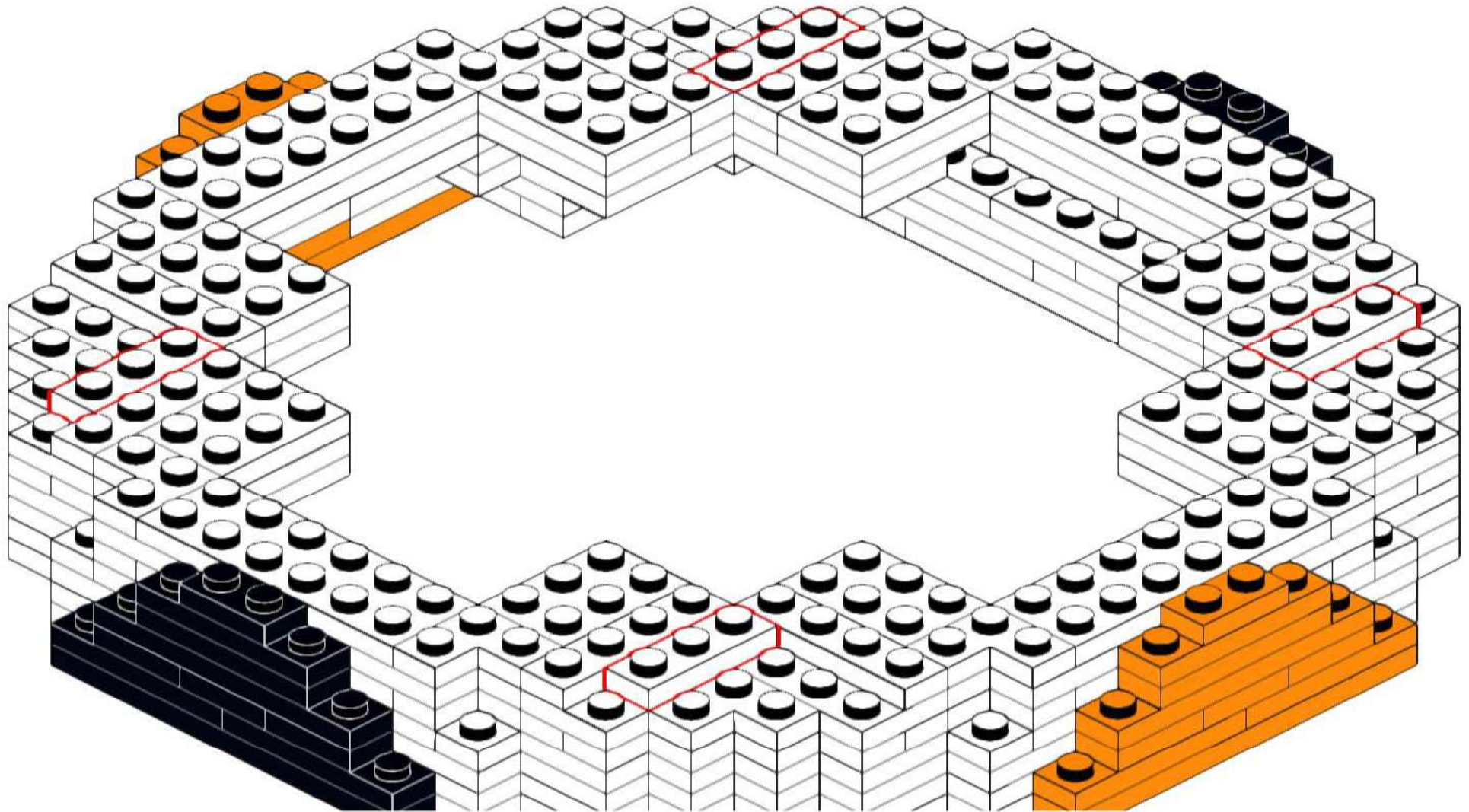
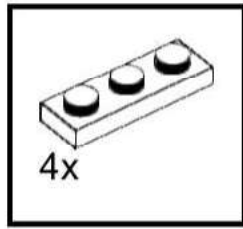

196

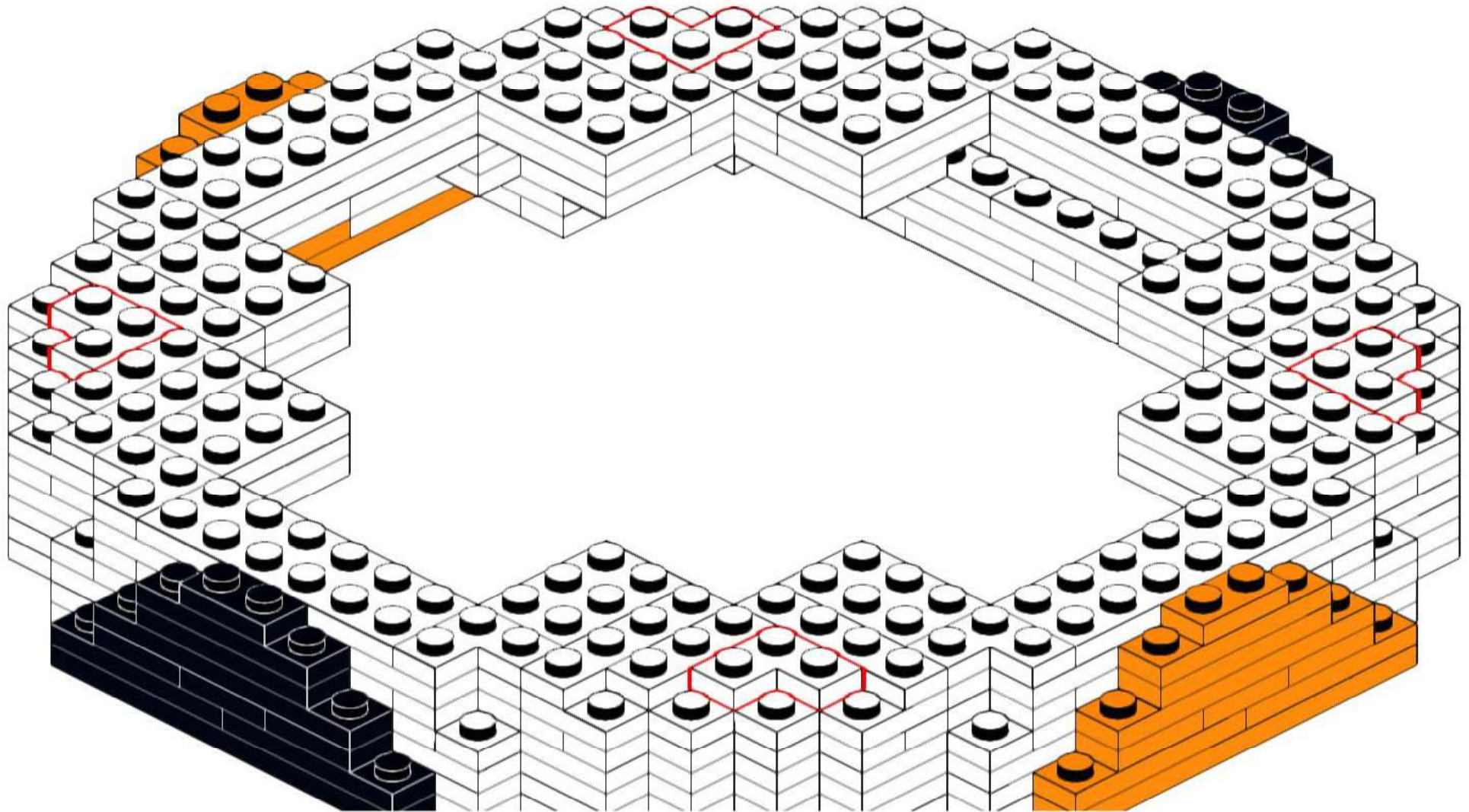
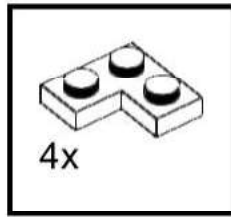

197

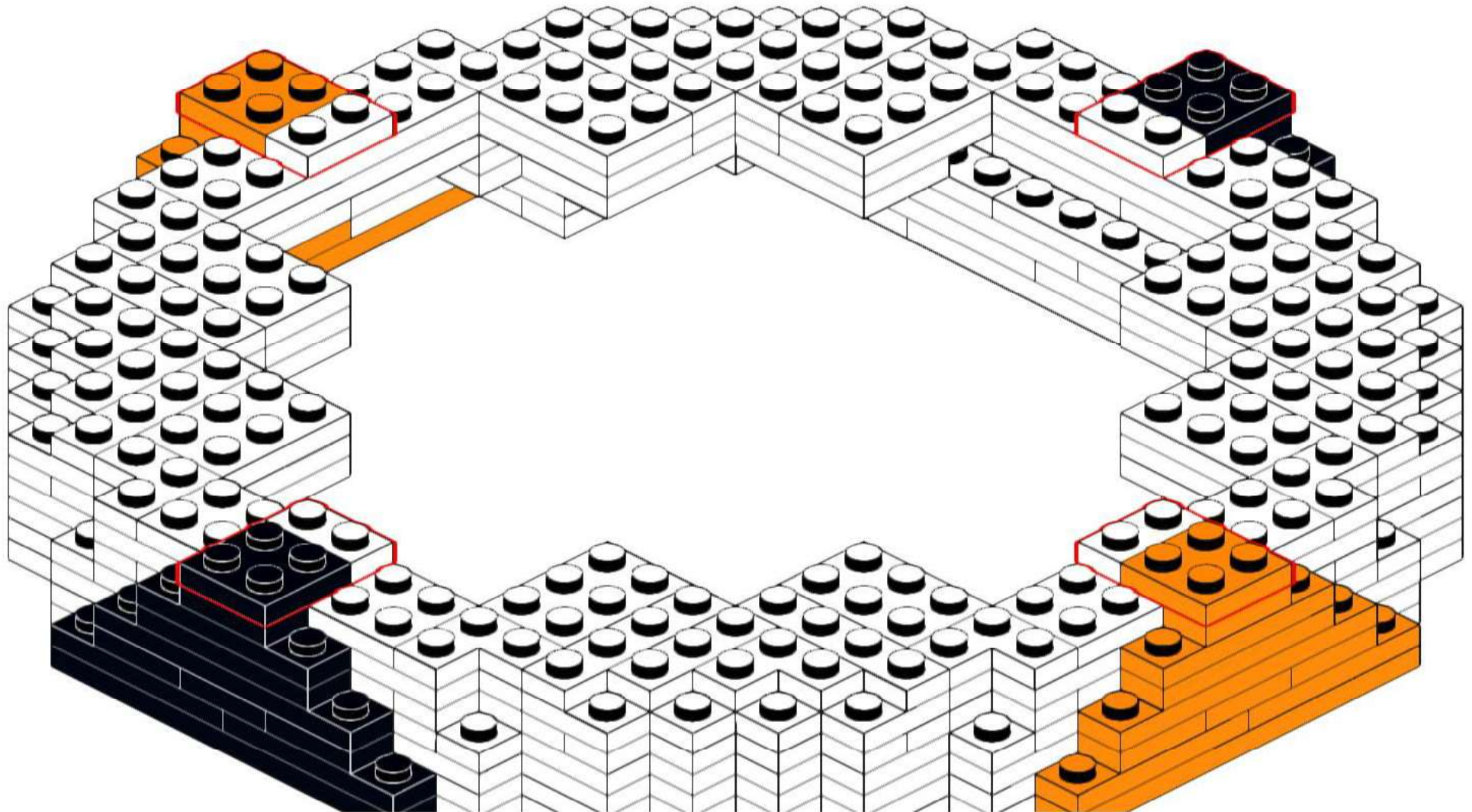
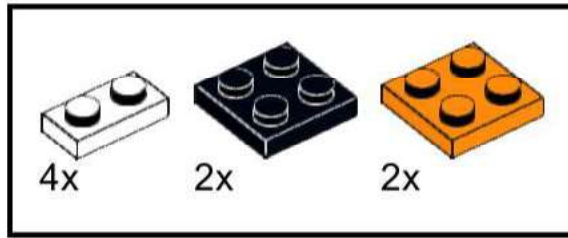

198

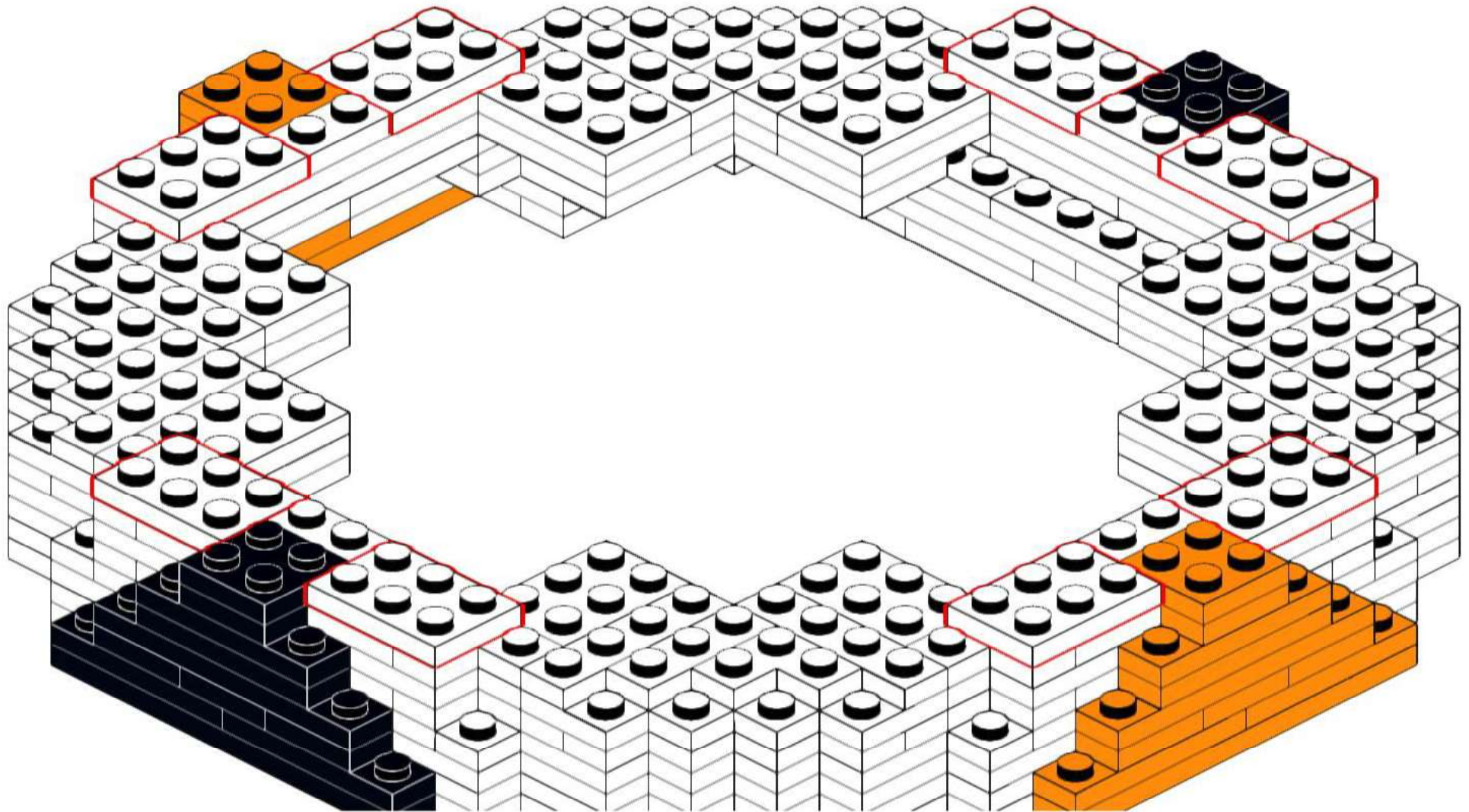
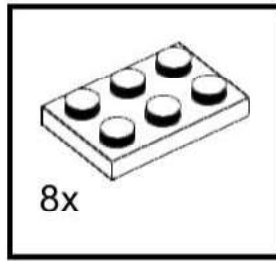

199

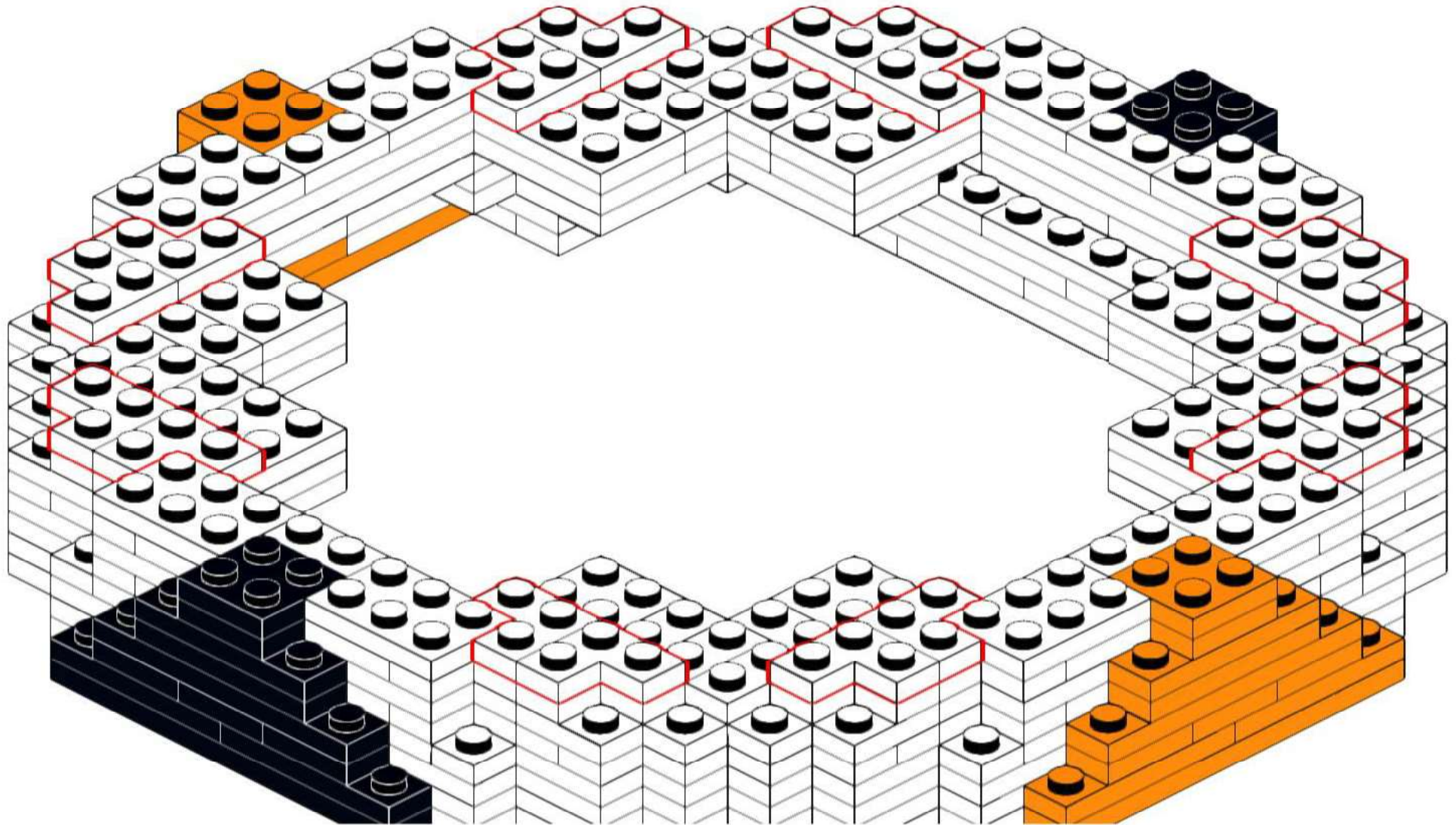
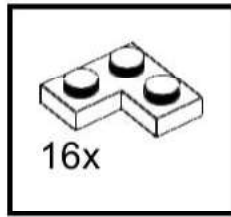

200

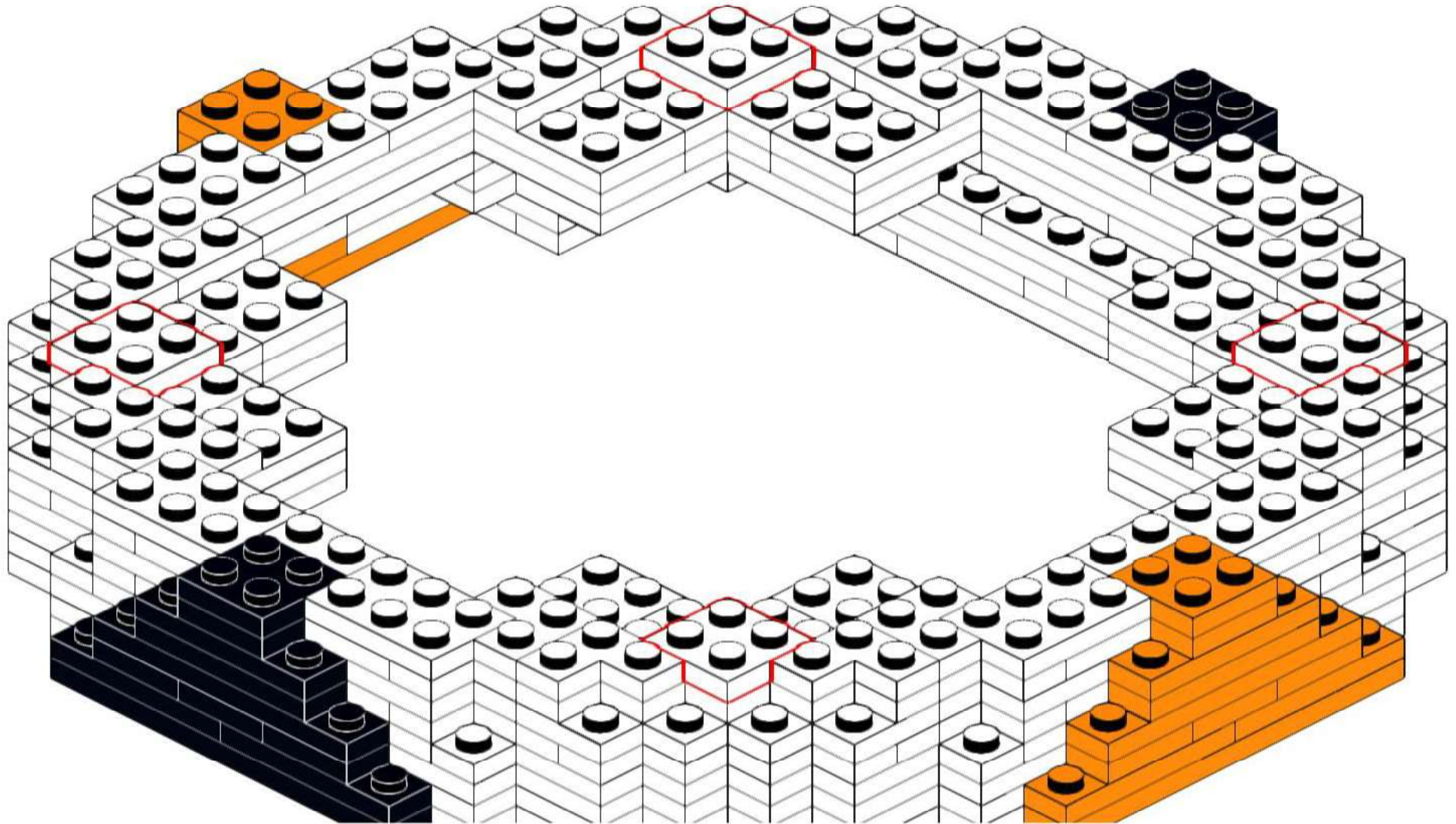
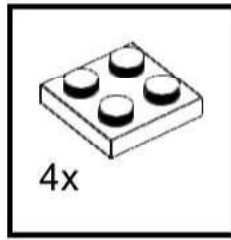

201

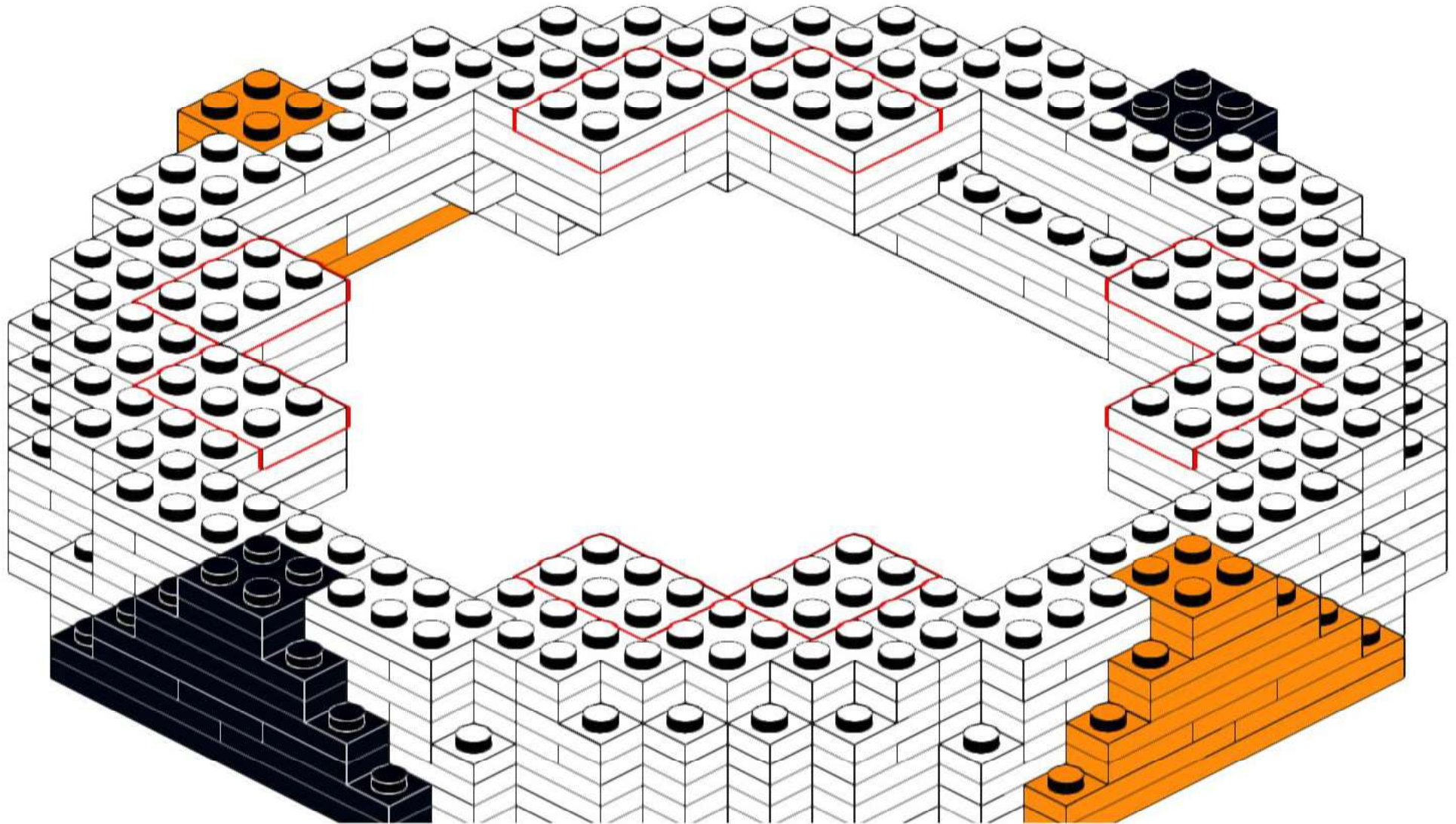
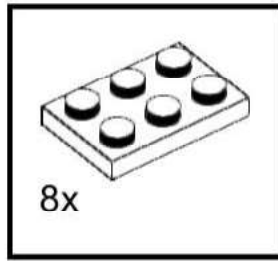

202

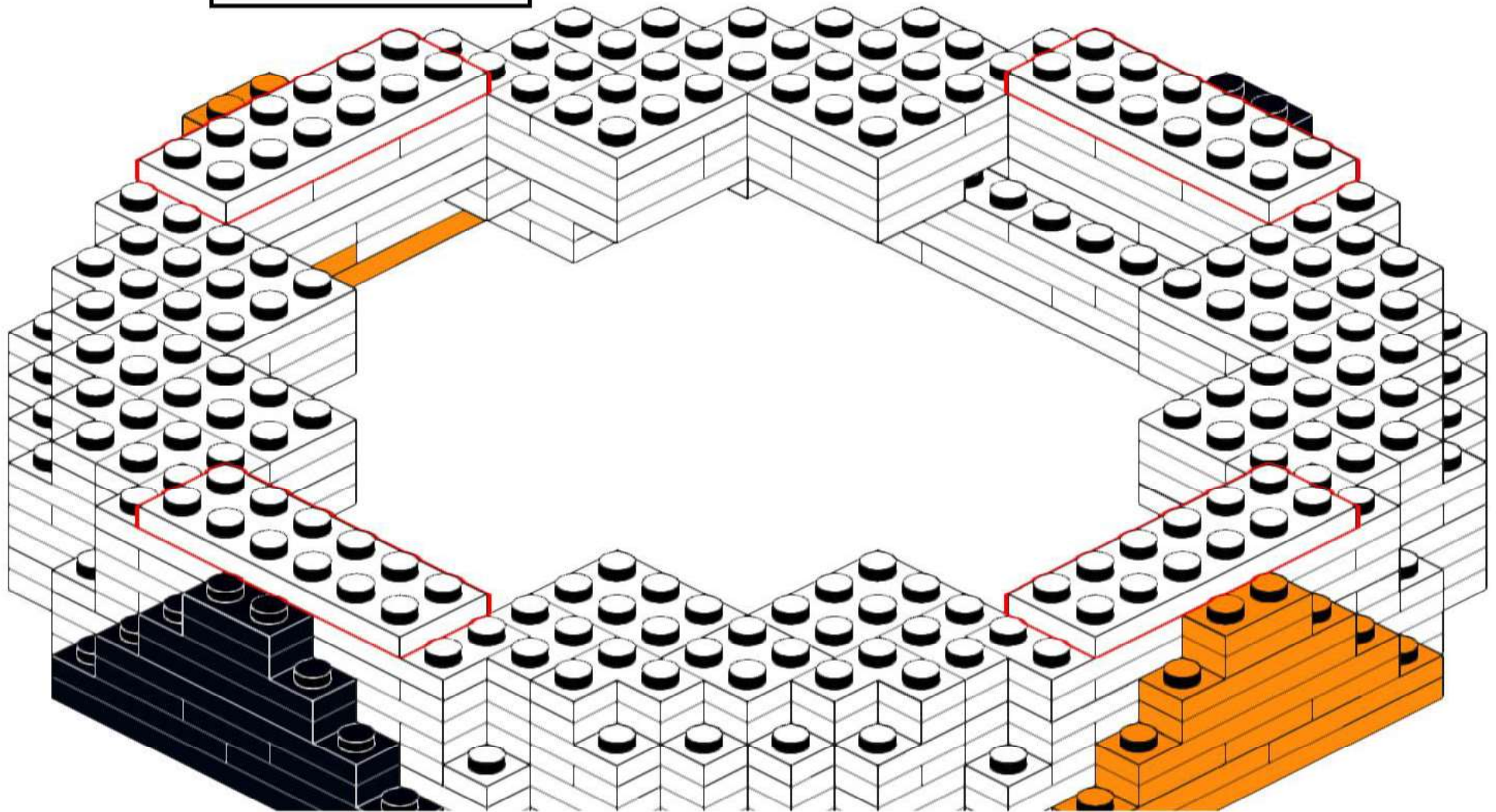
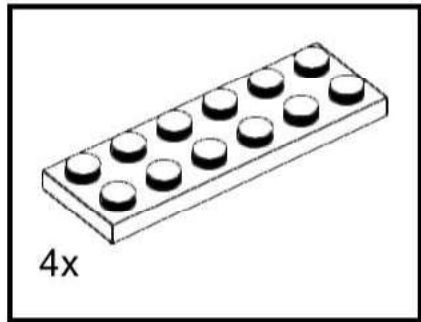

203

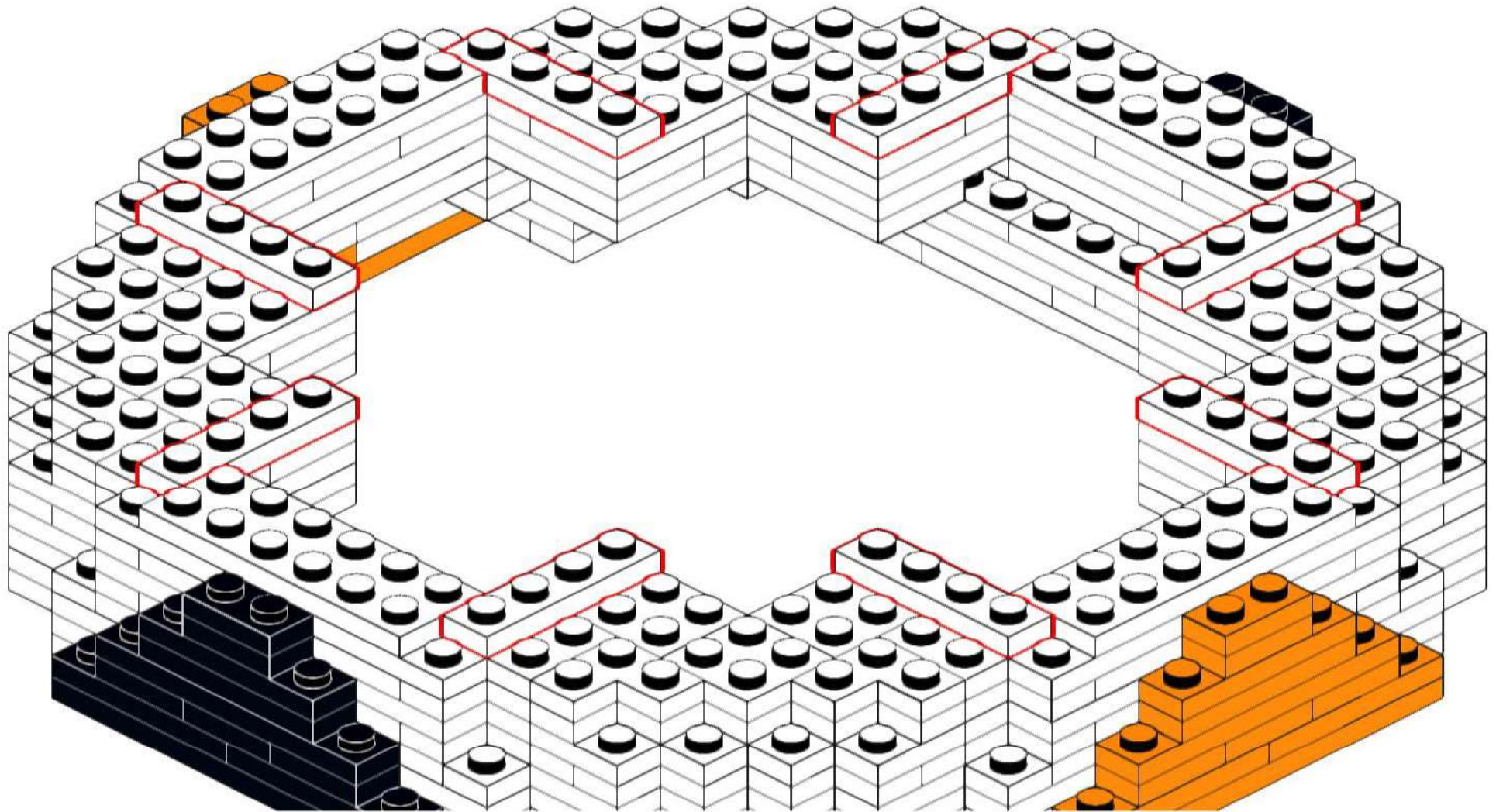
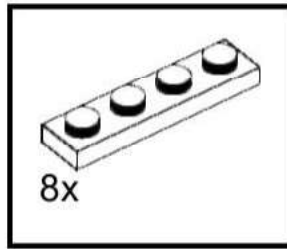

204

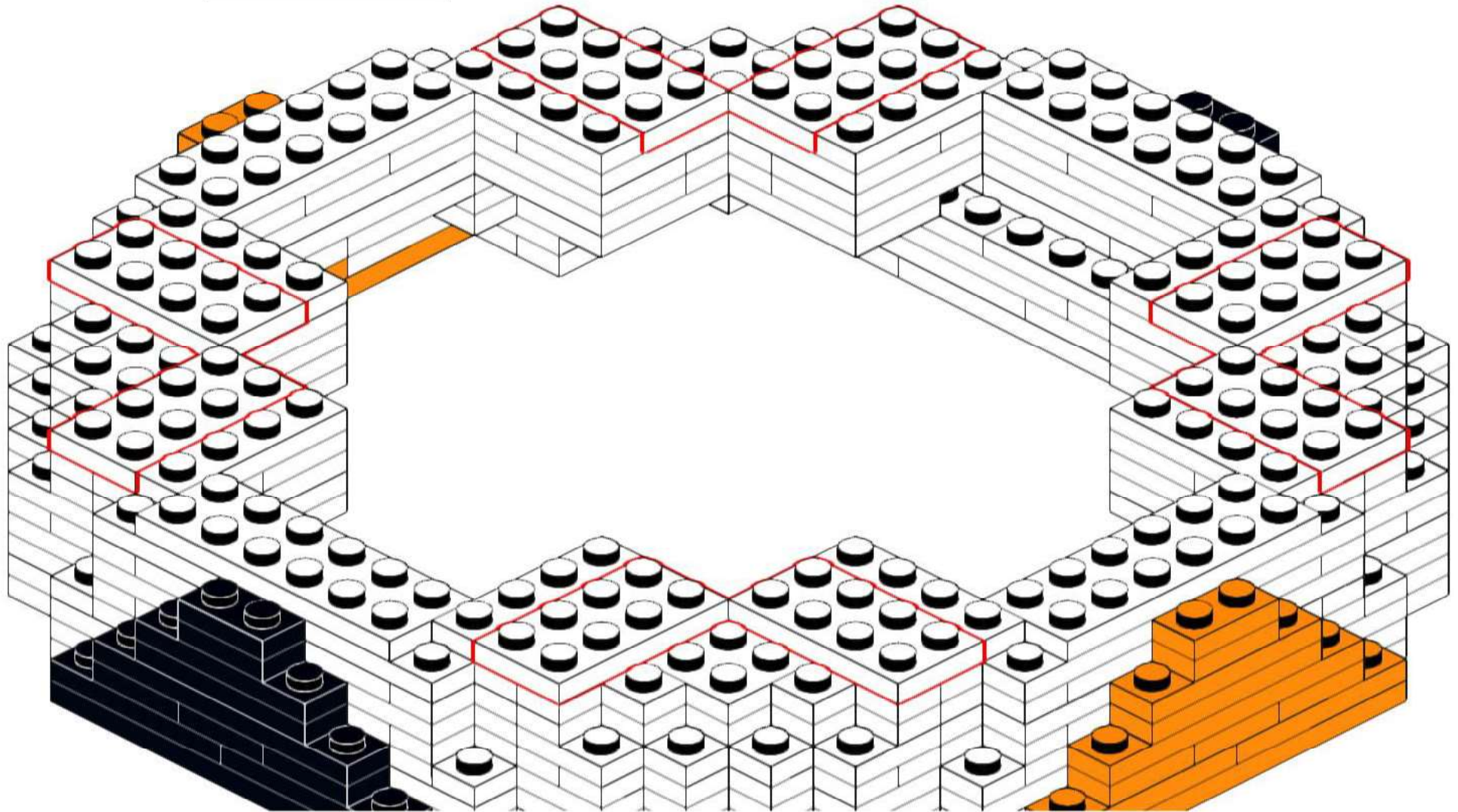
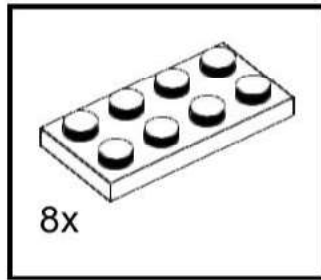

205

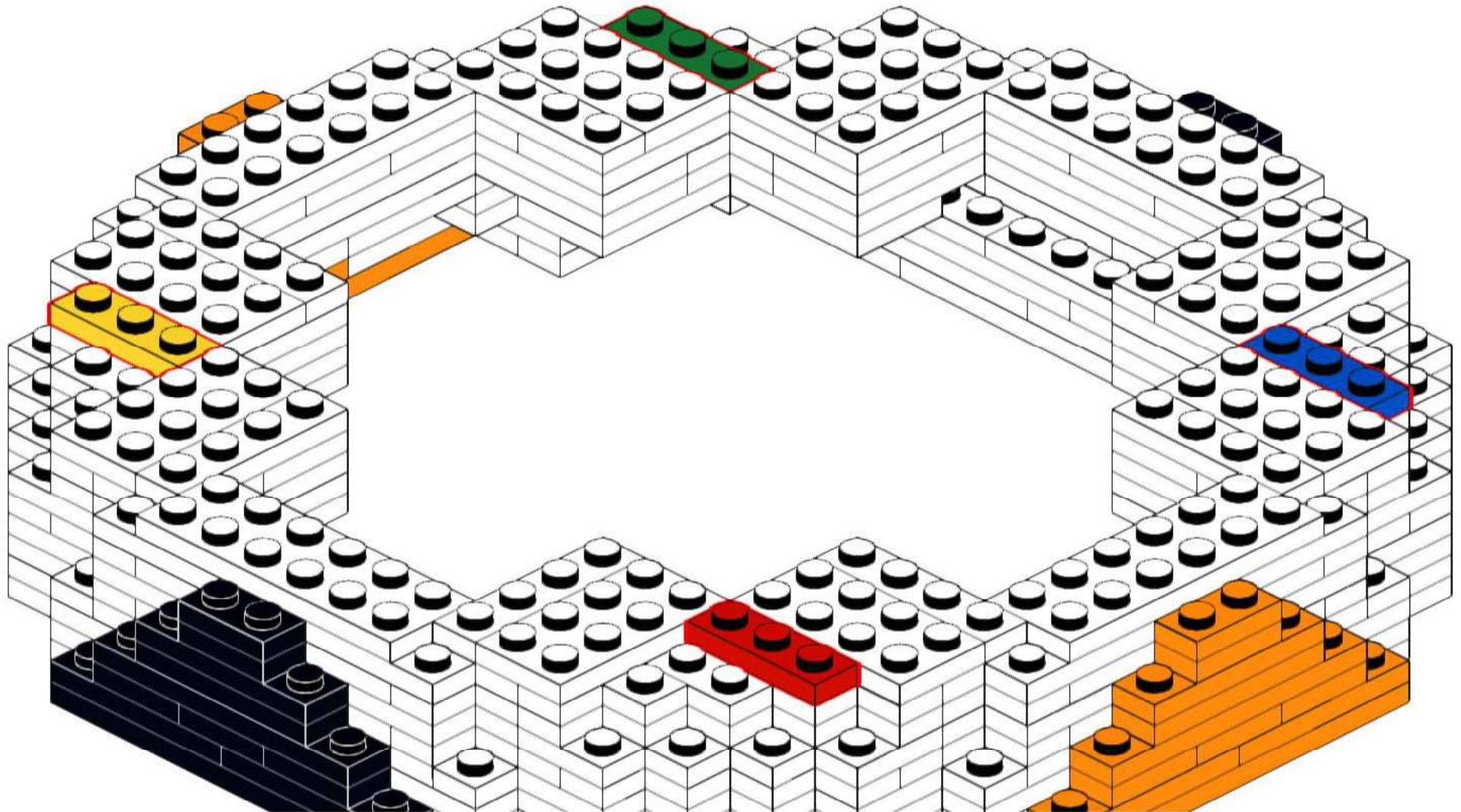
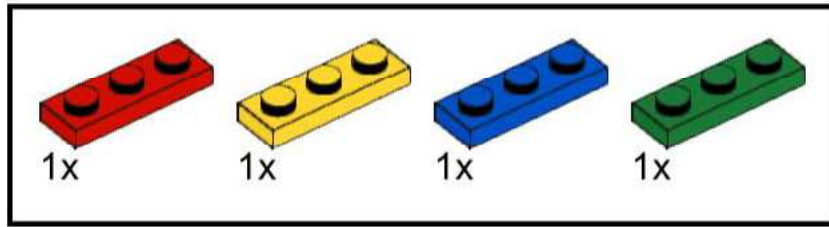

206

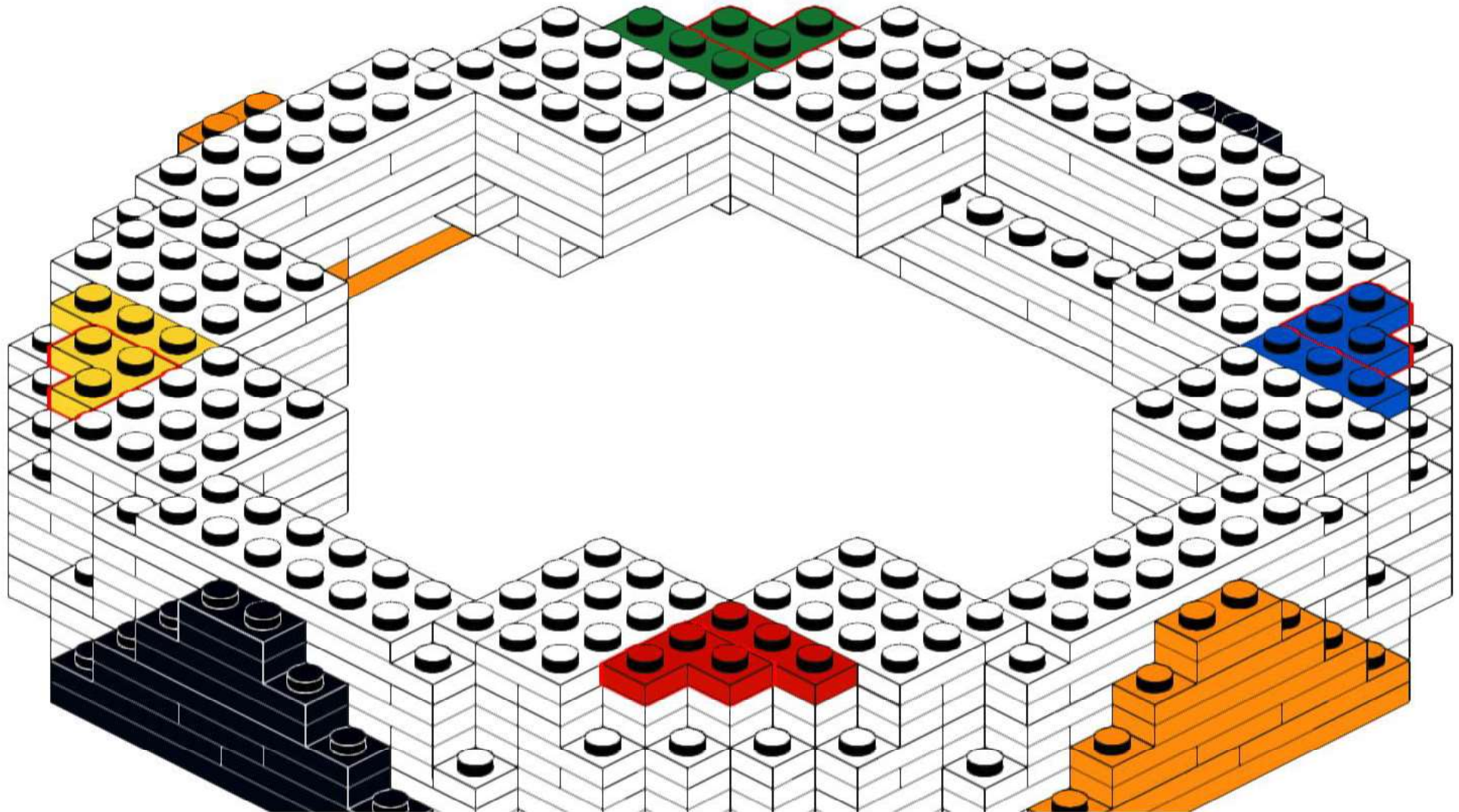
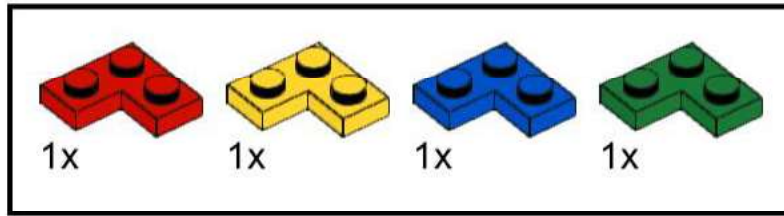

207

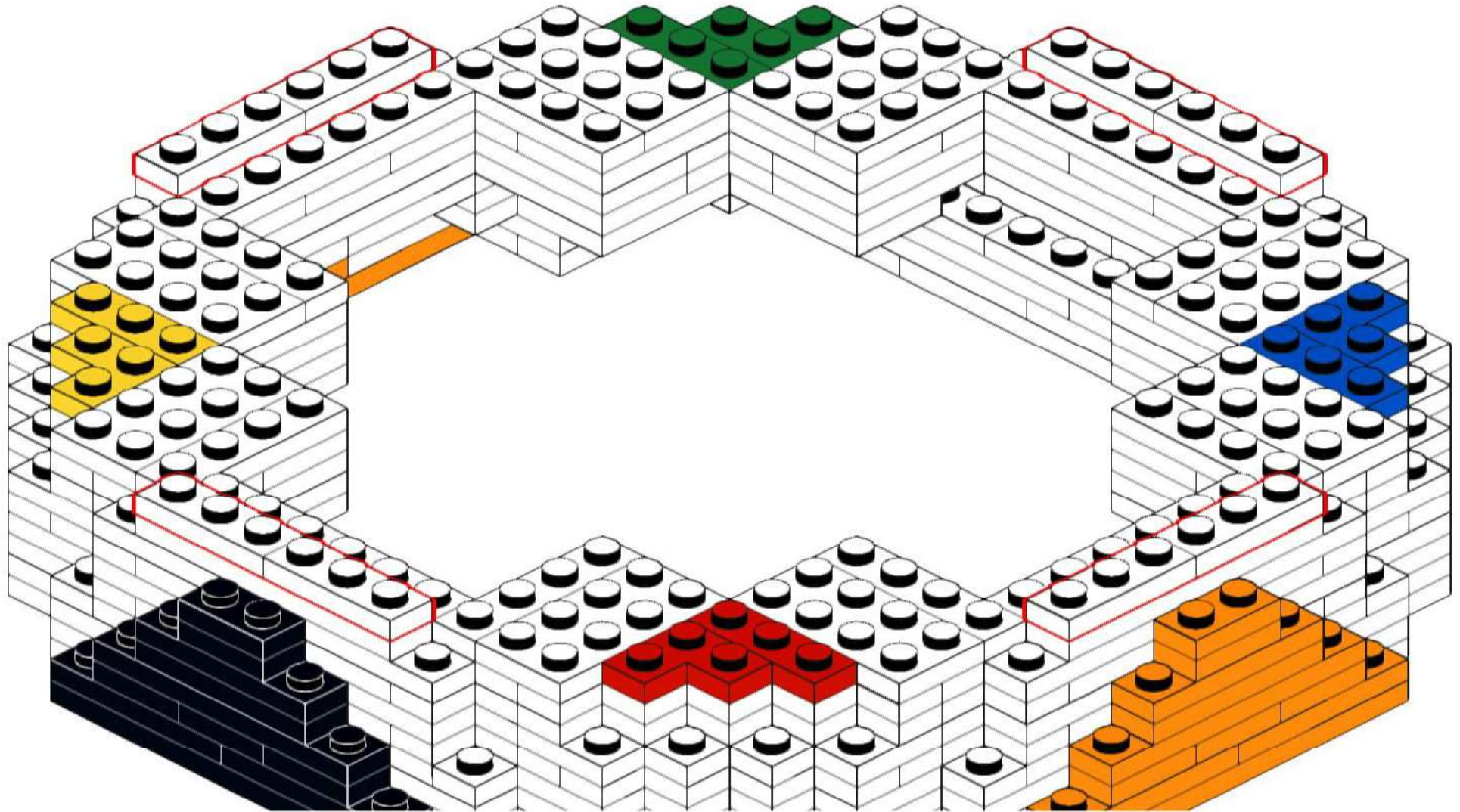
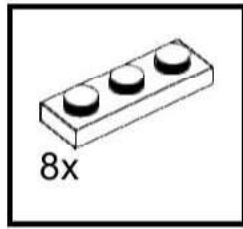

208

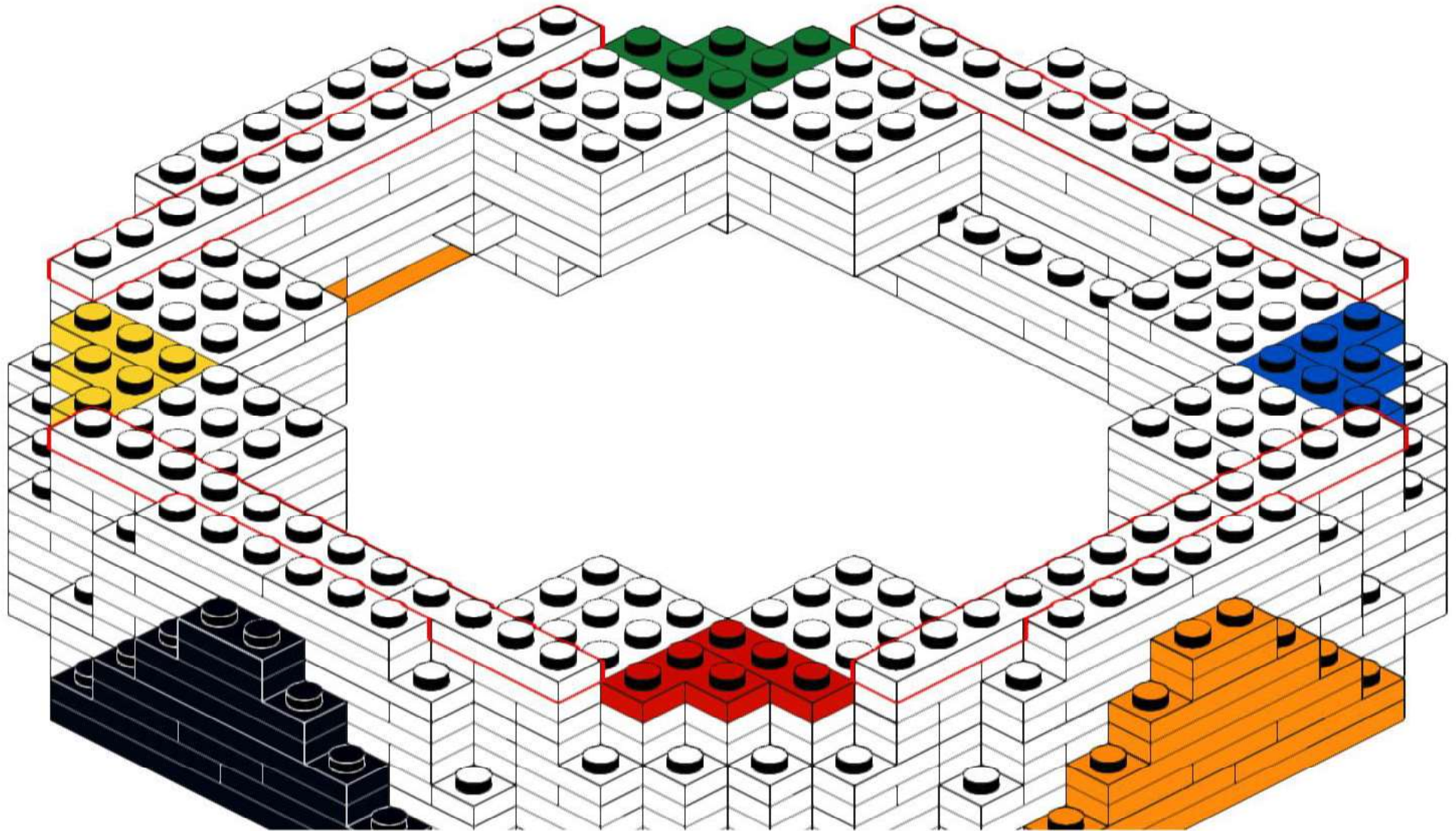
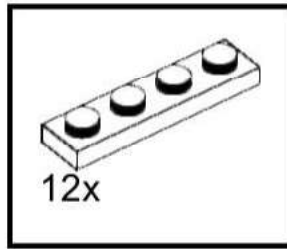

209

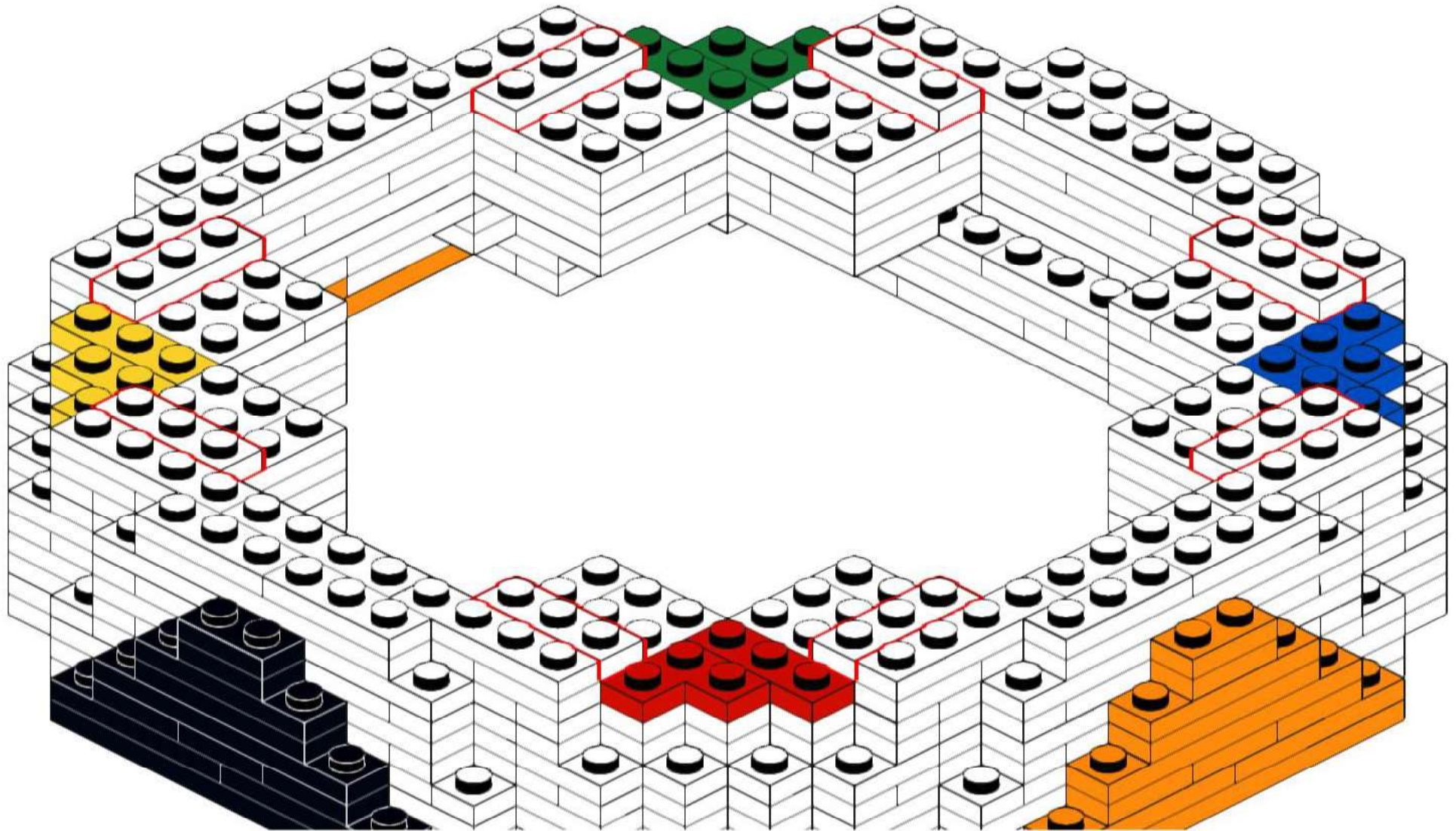
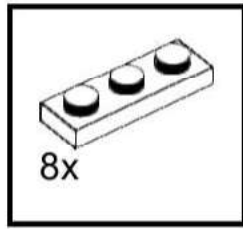

210

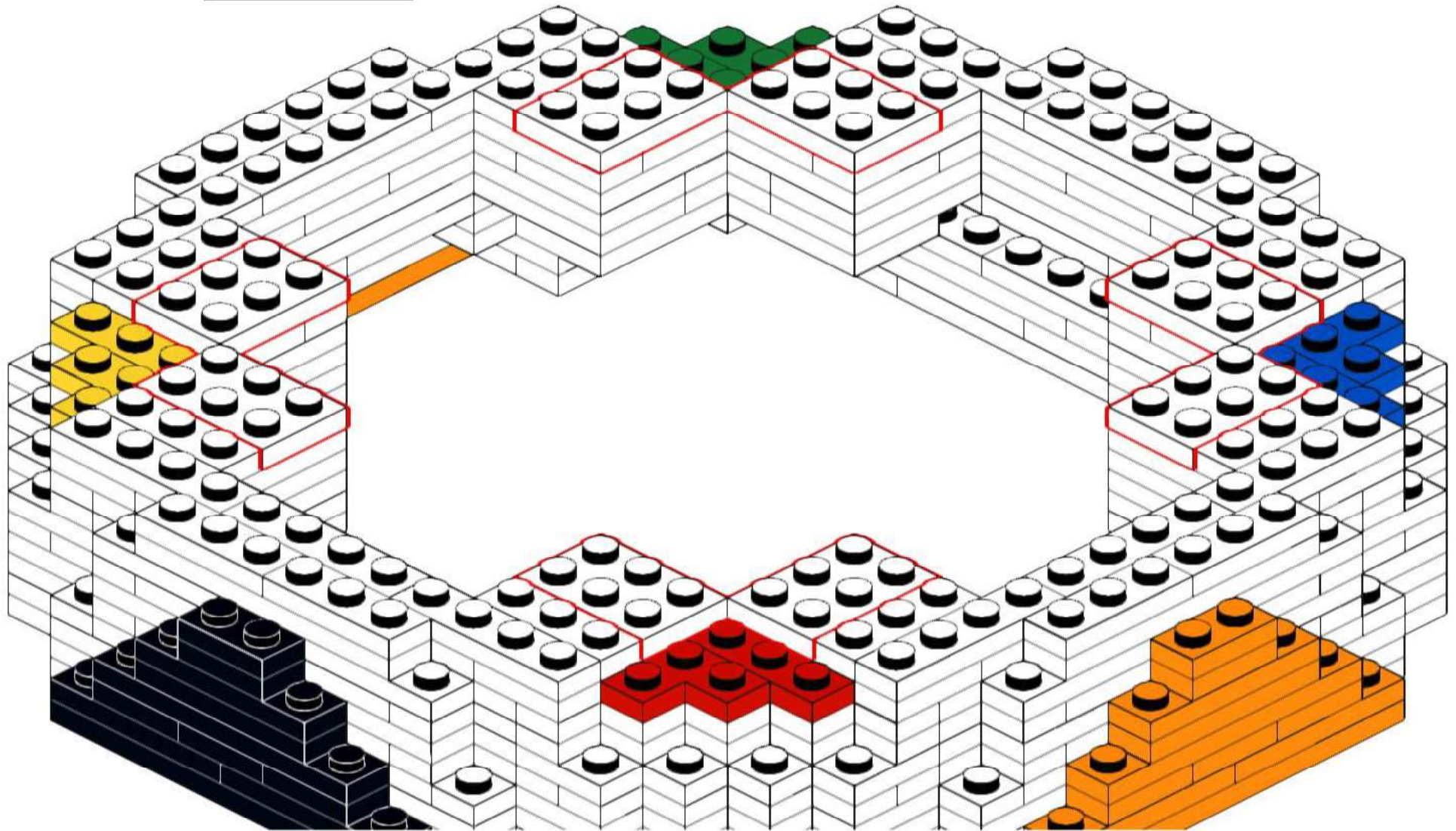
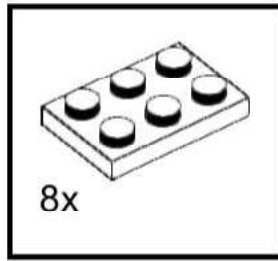

211

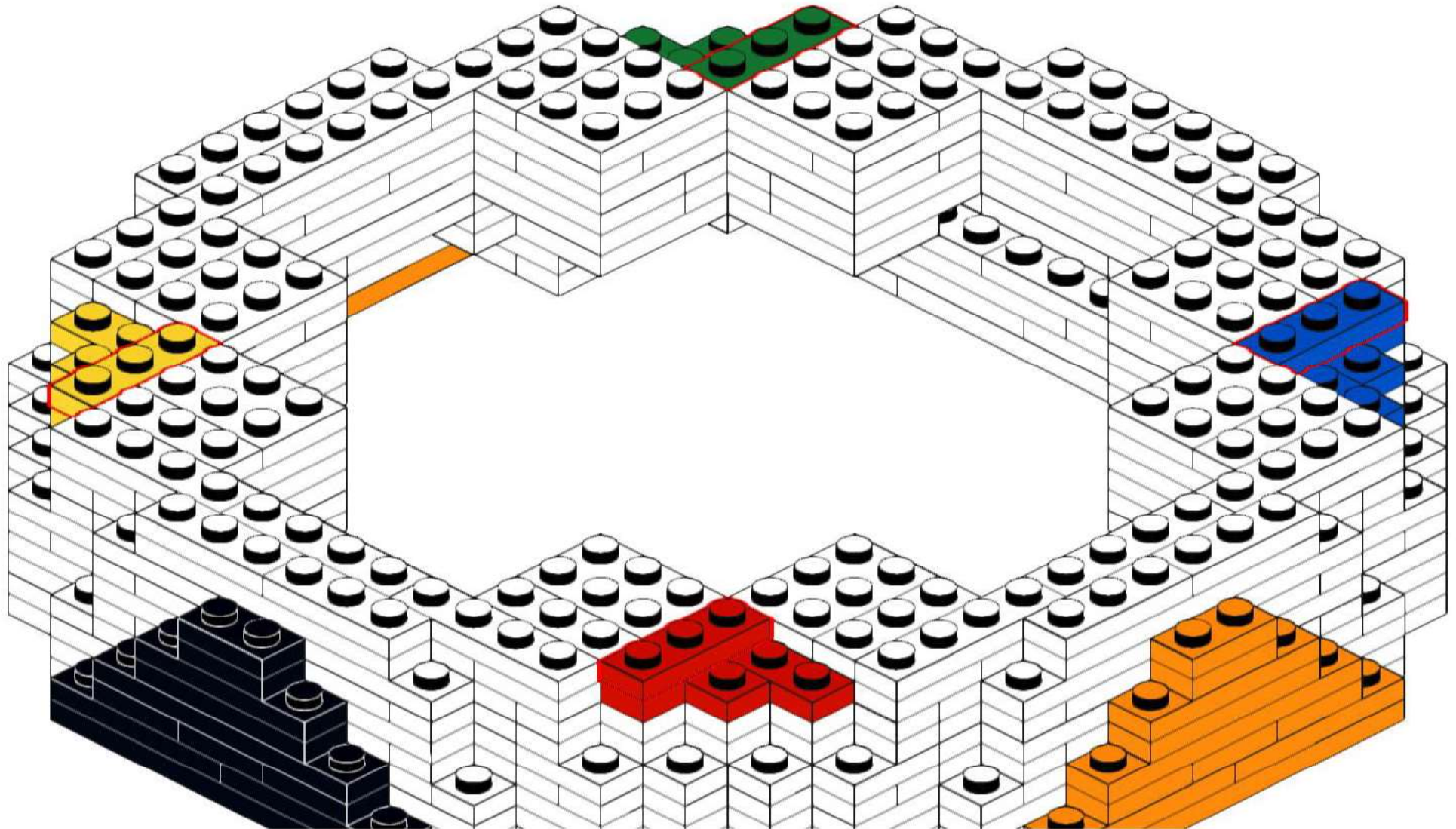
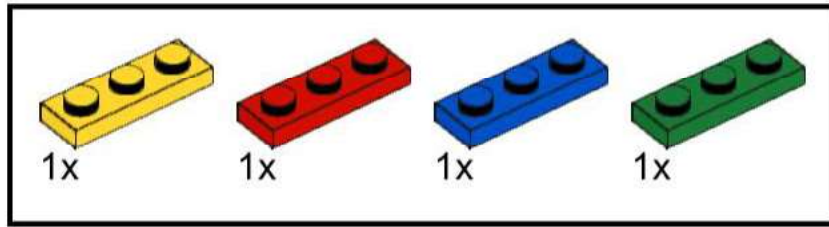

212

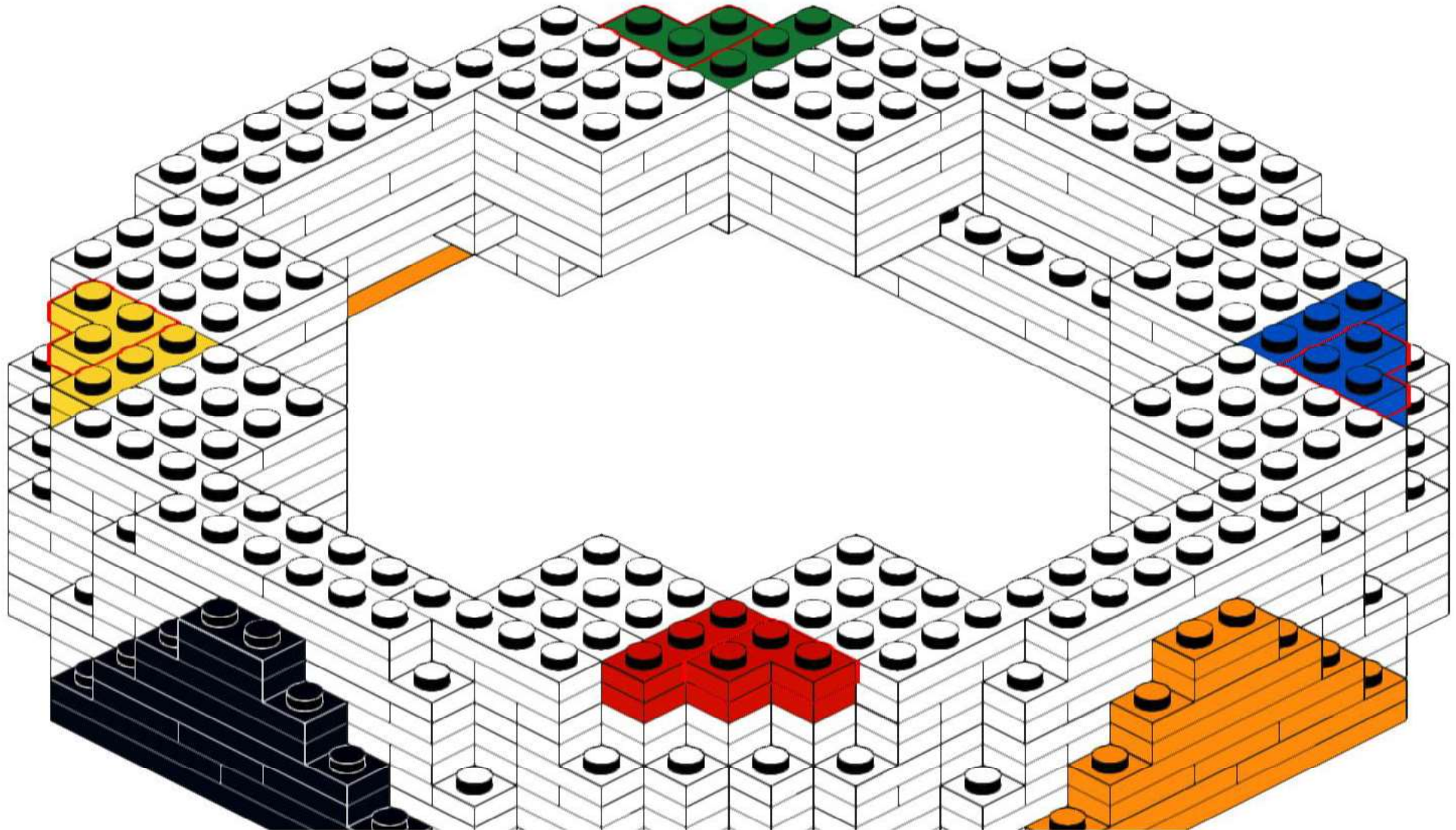
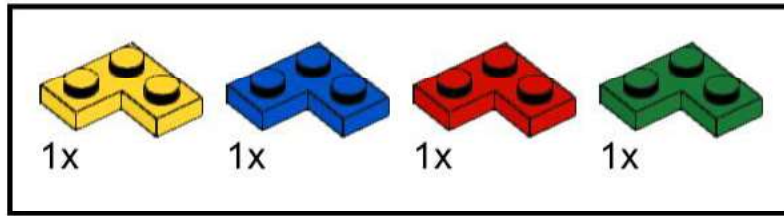

213

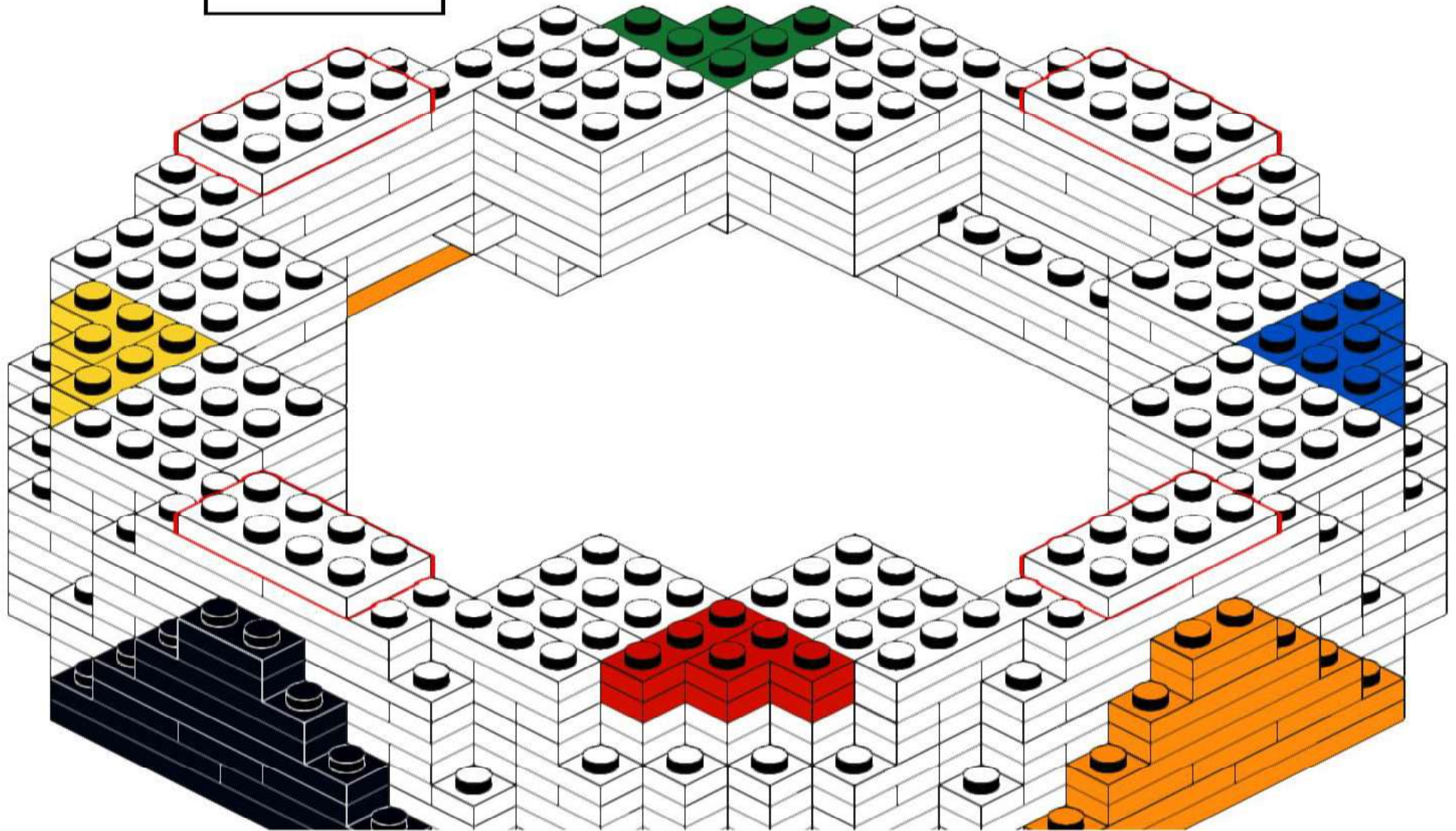
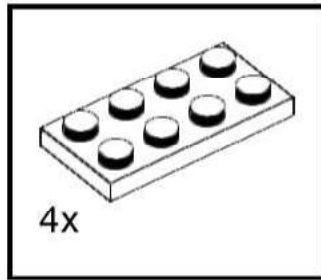

214

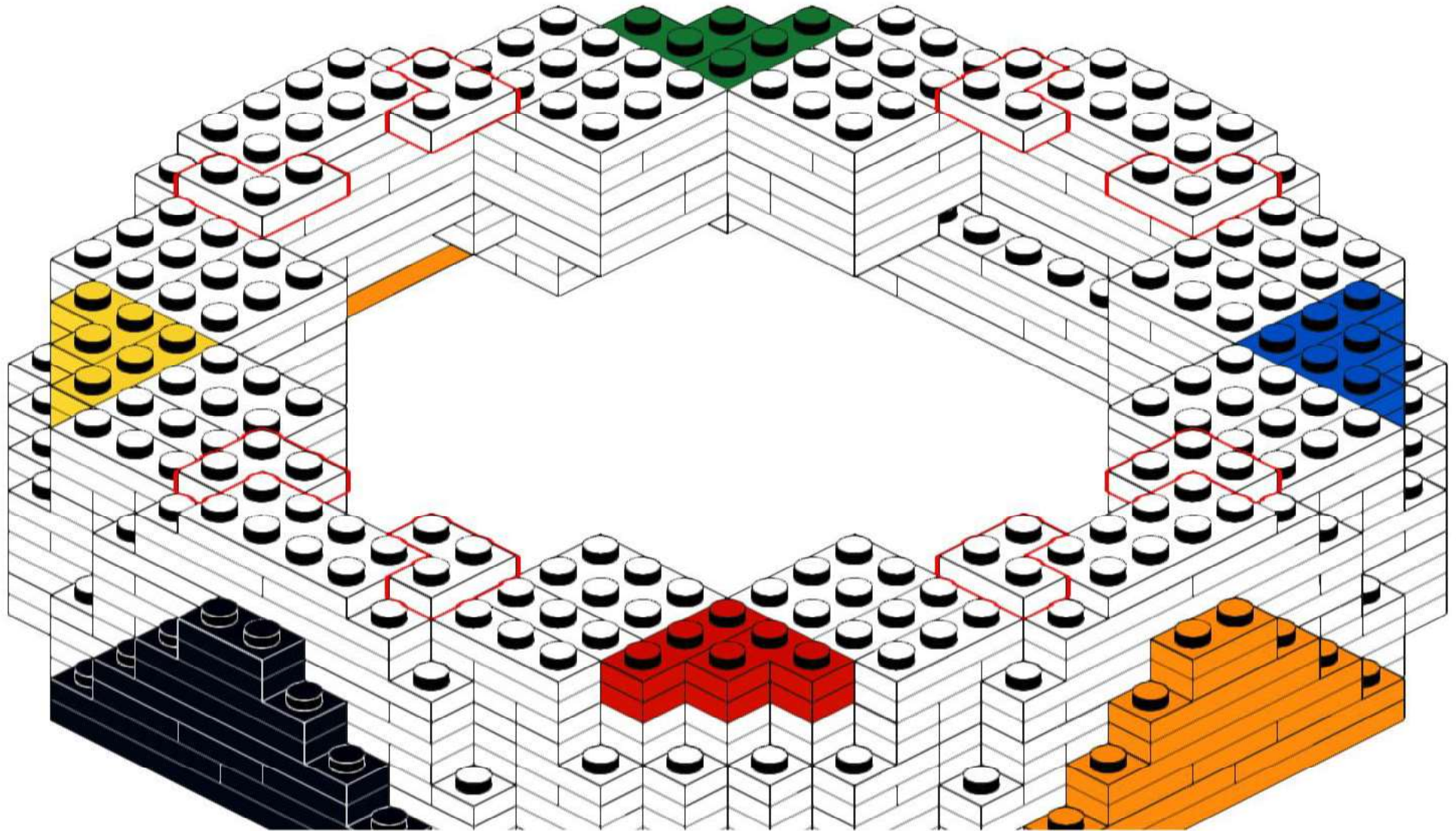
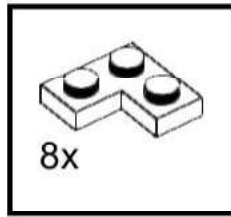

215

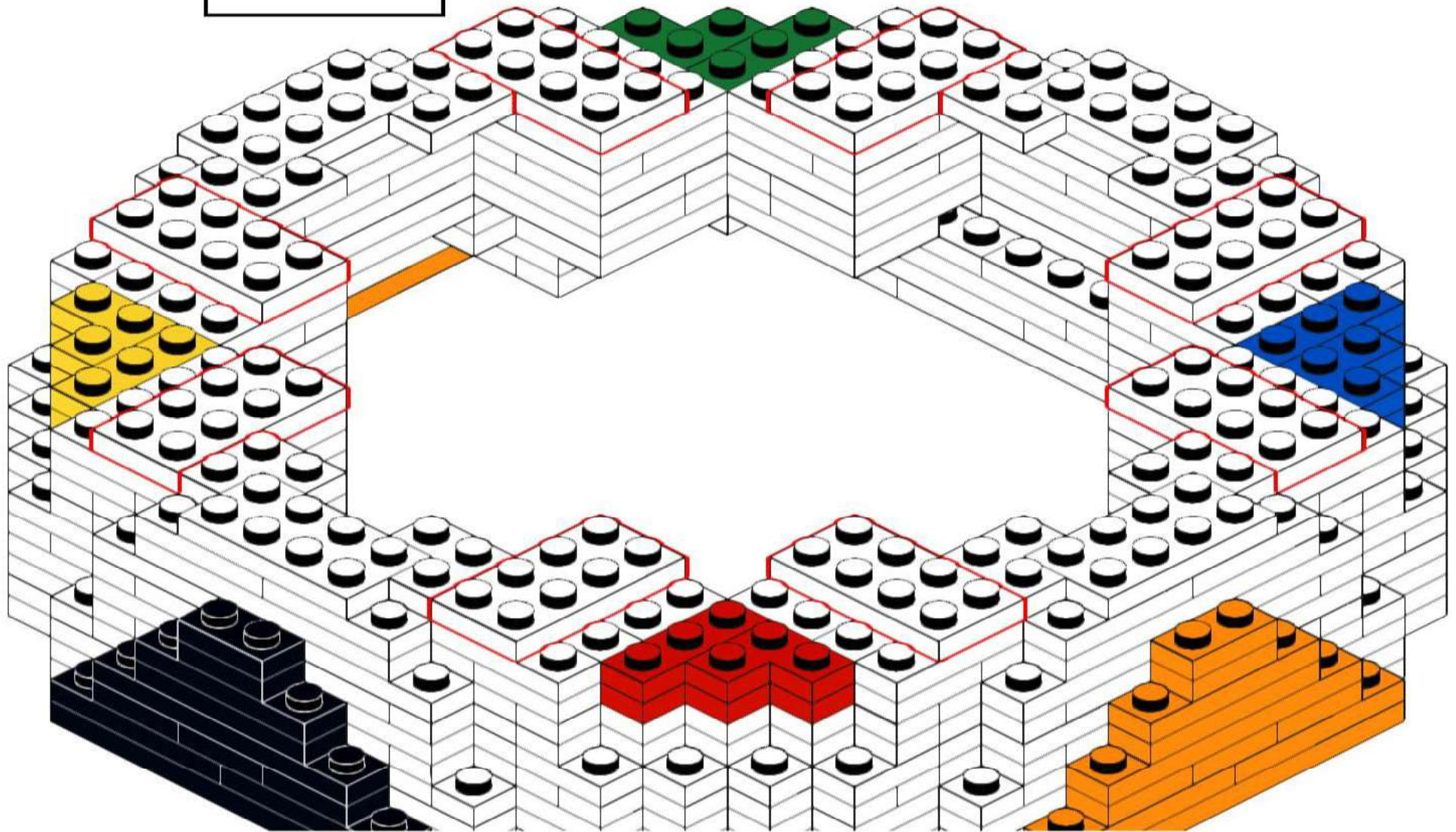
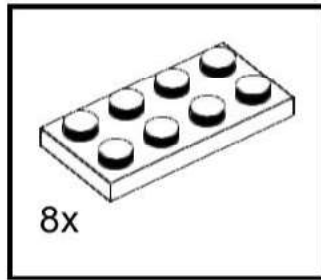

216

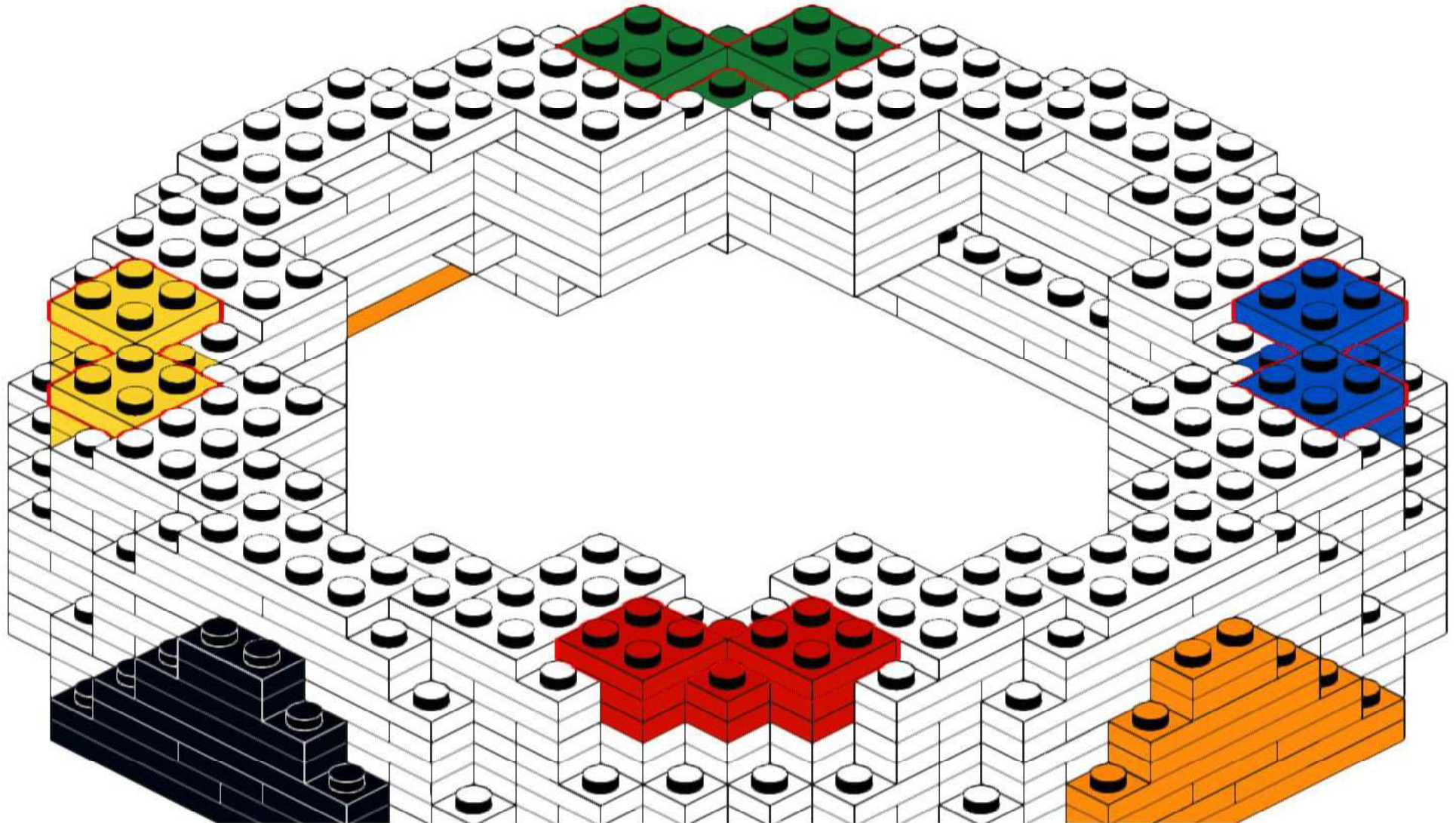
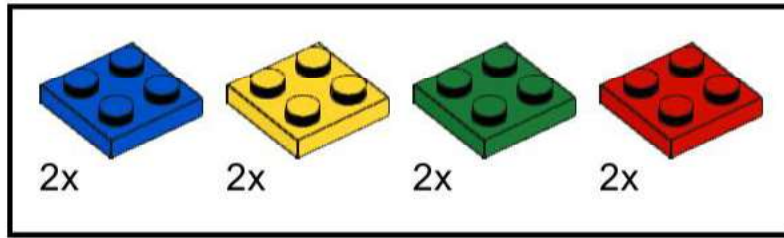

217

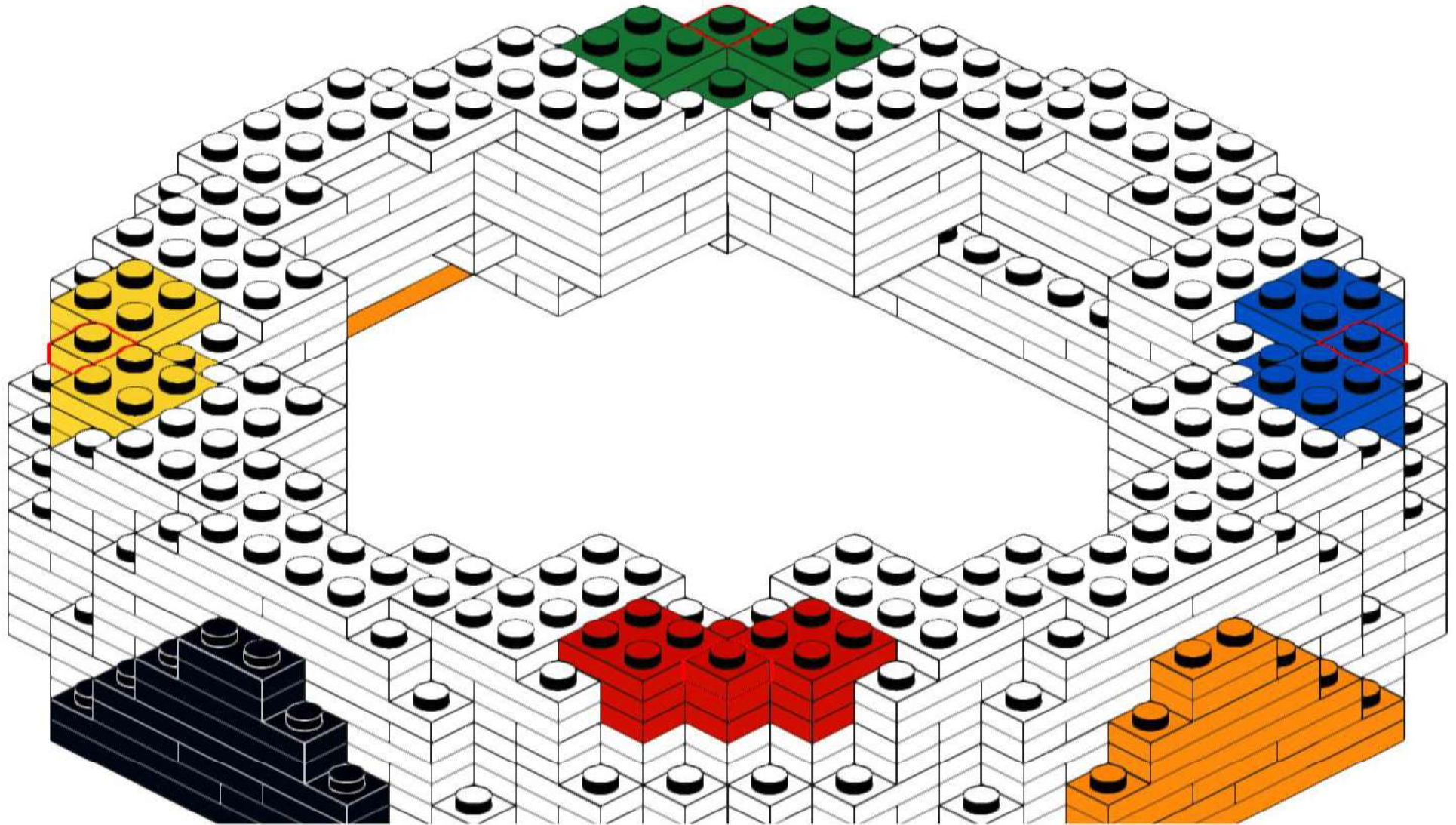
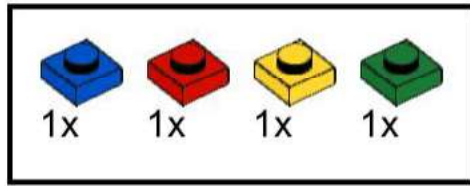

218

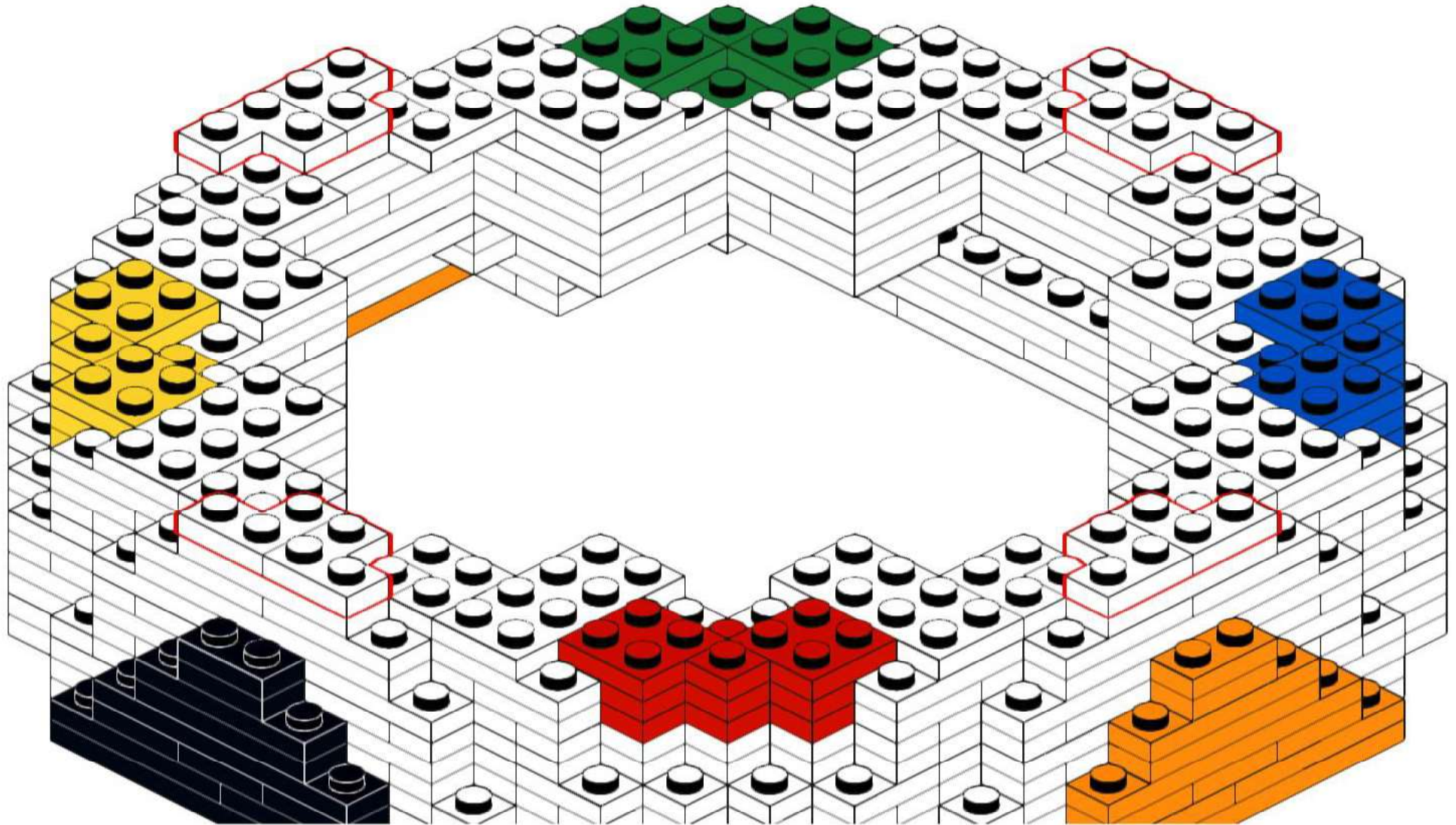
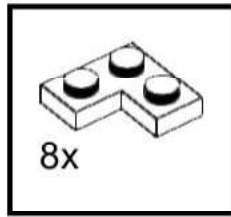

219

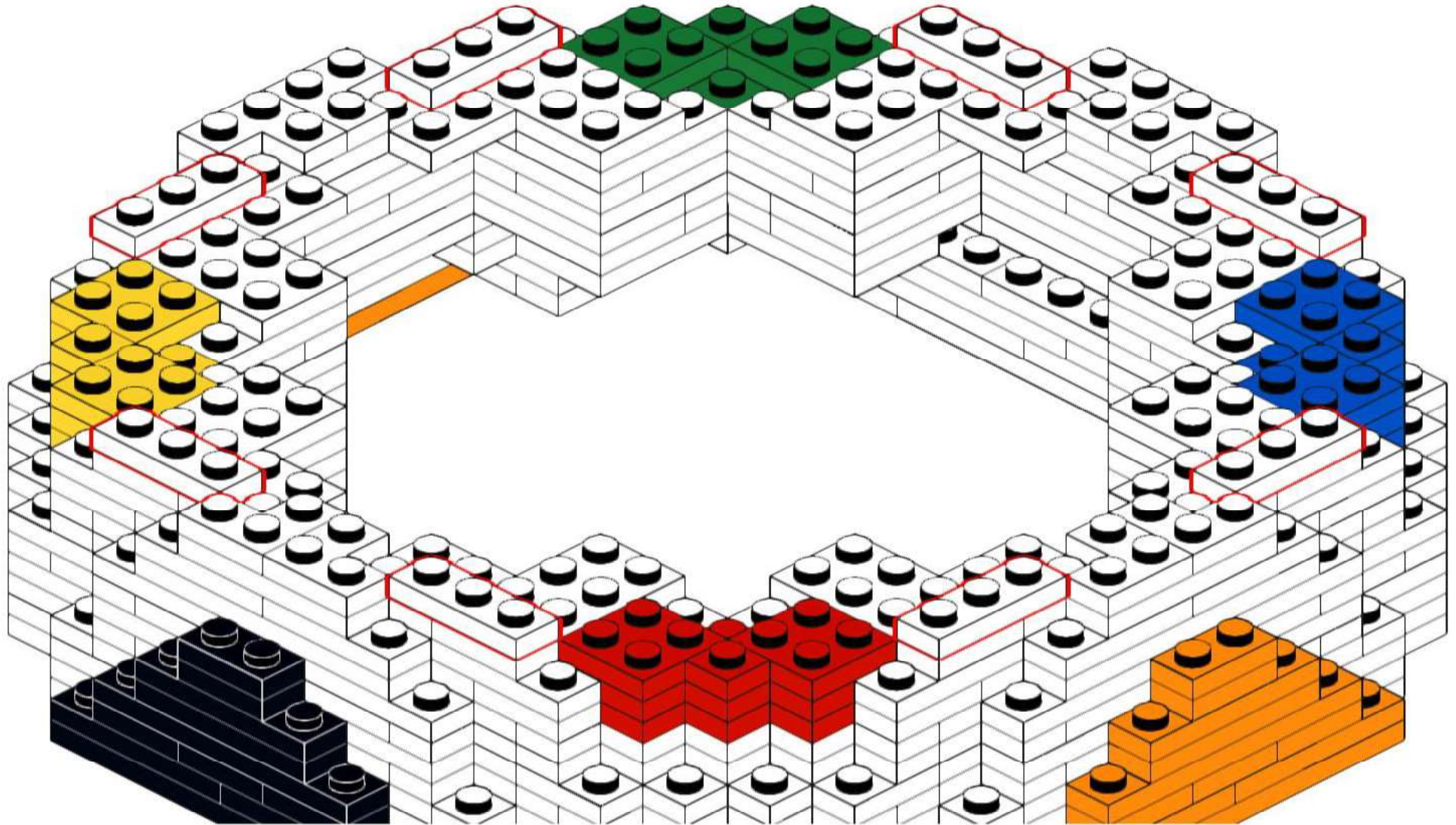
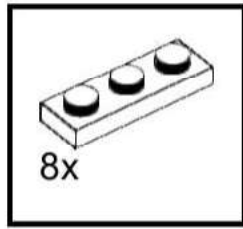

220

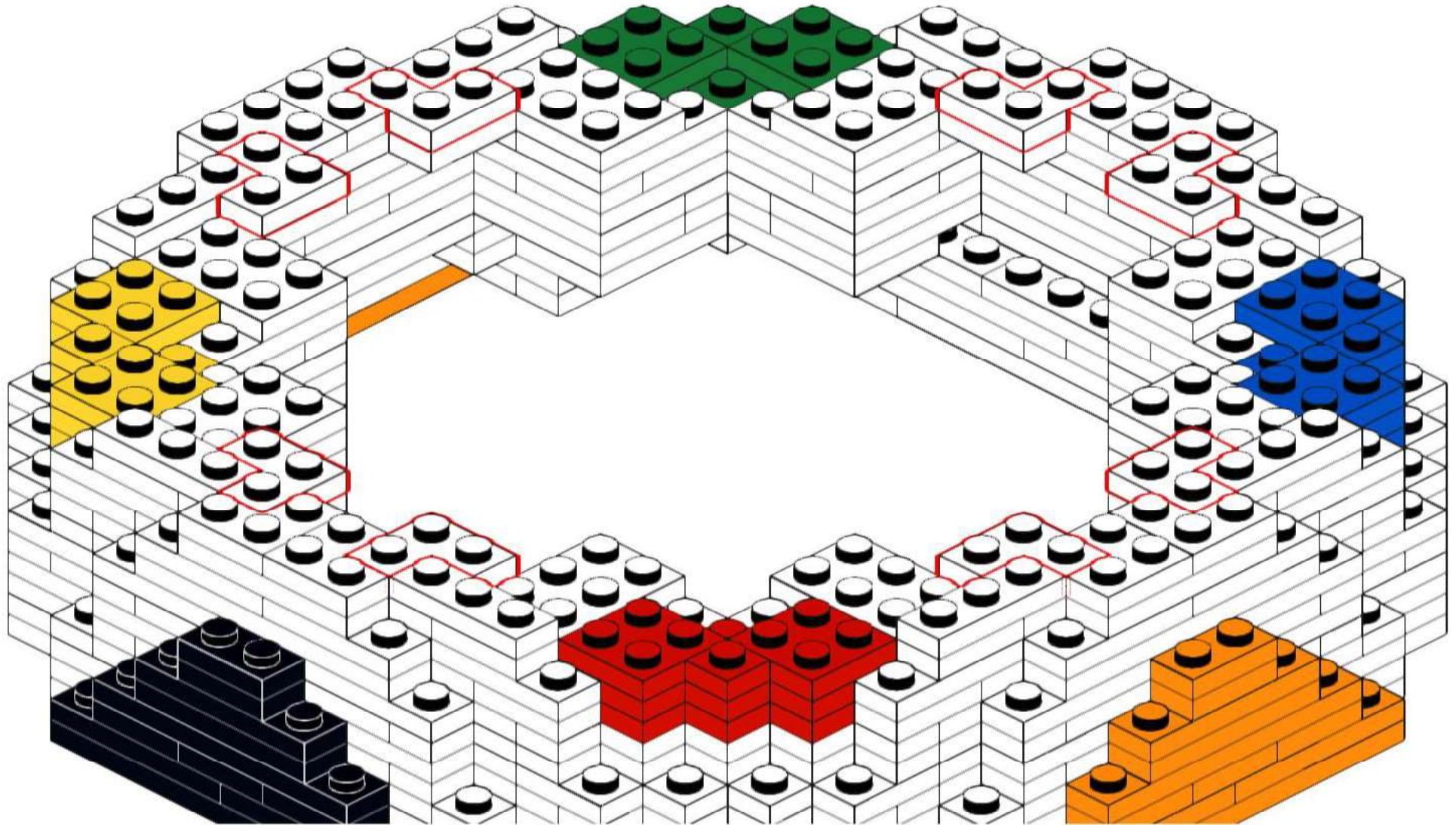
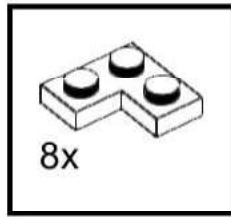

221

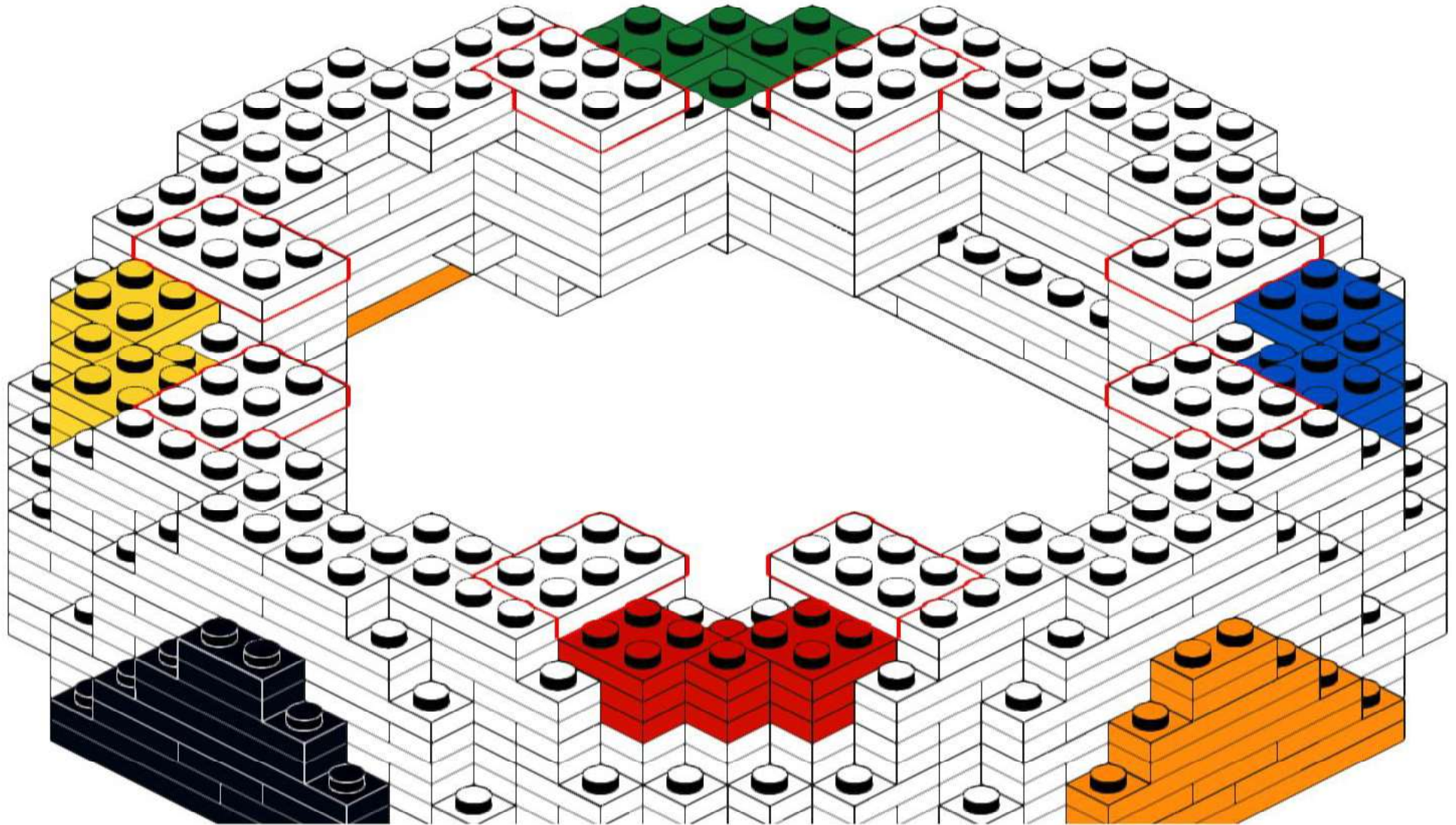
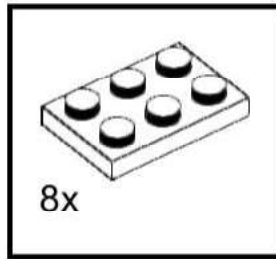

222

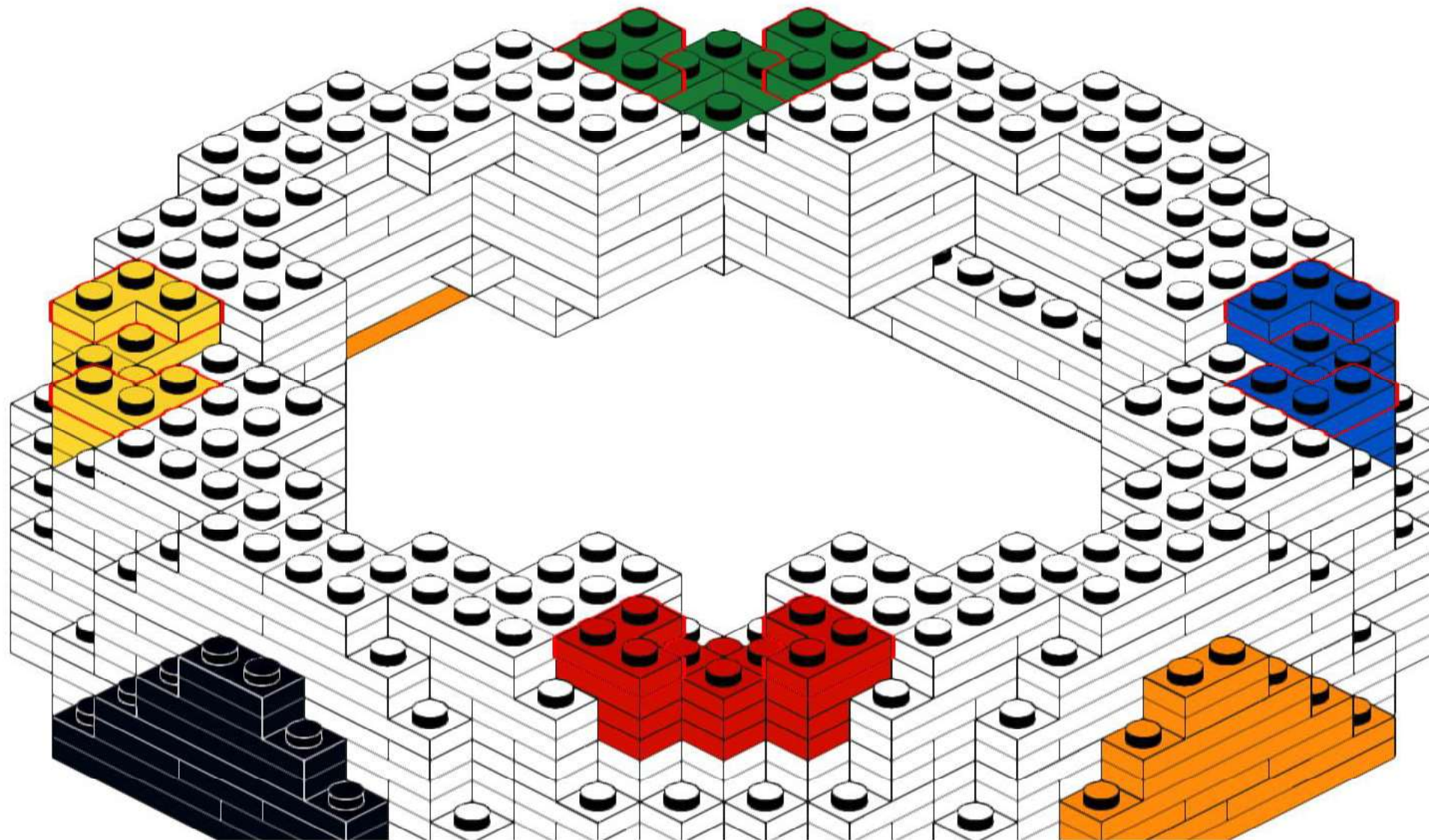
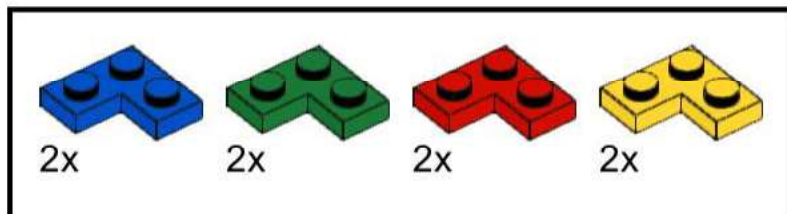

223

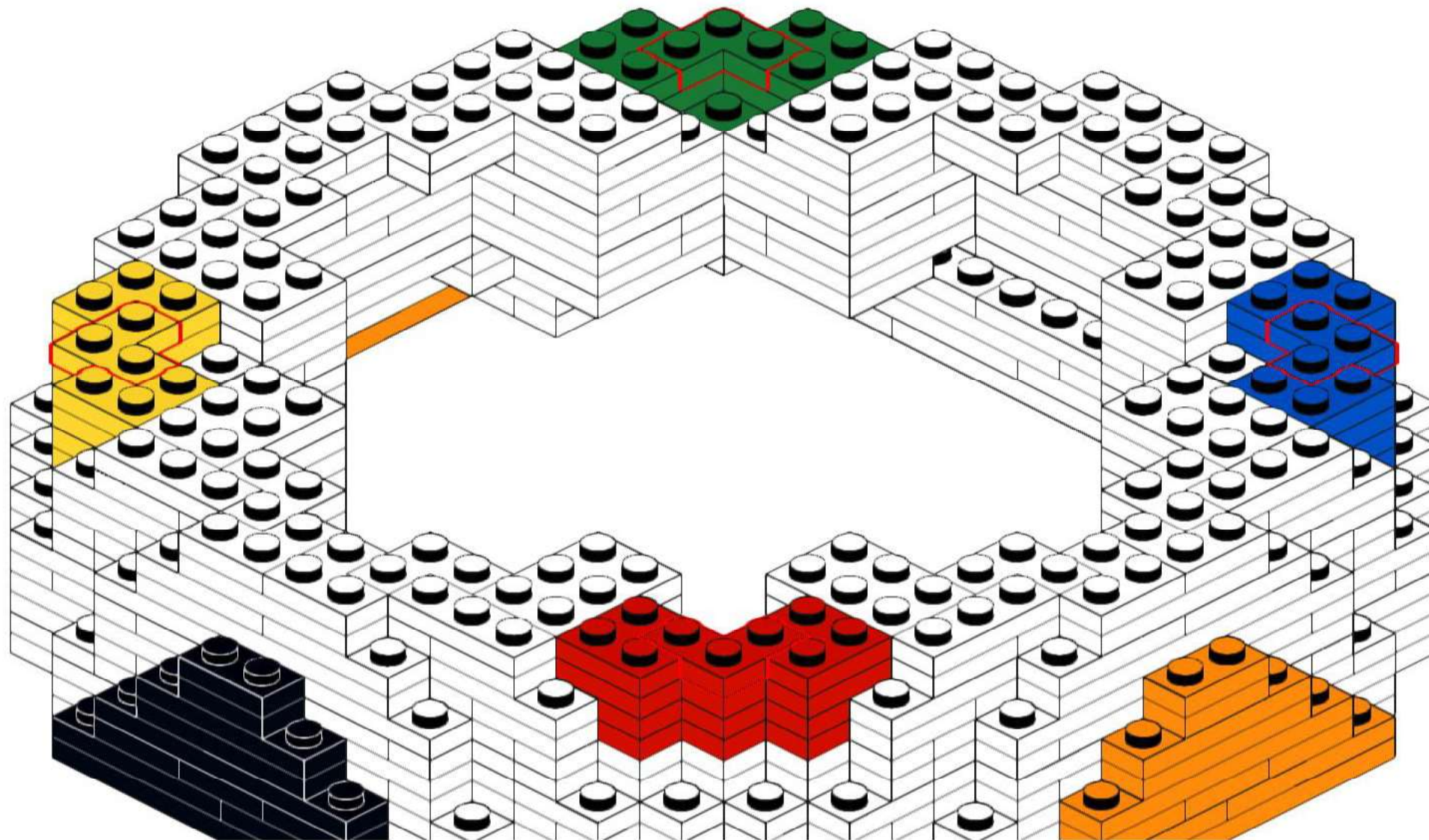
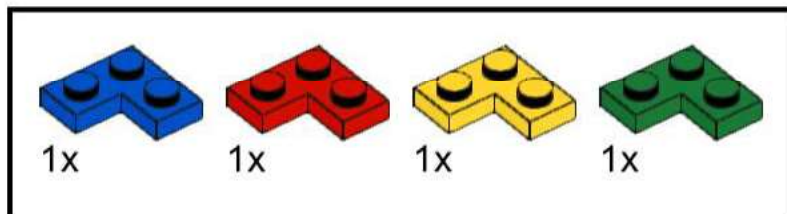

224

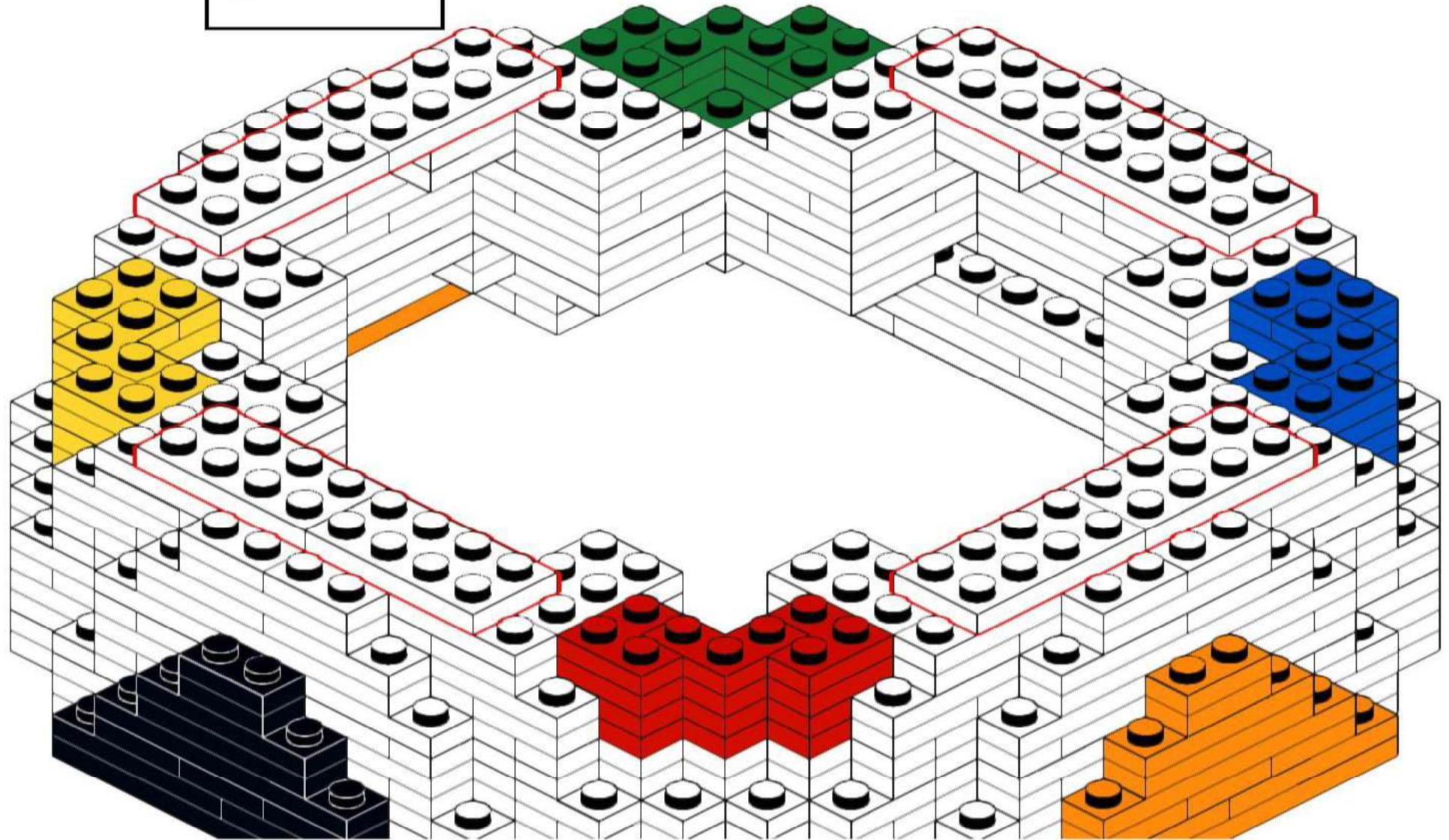
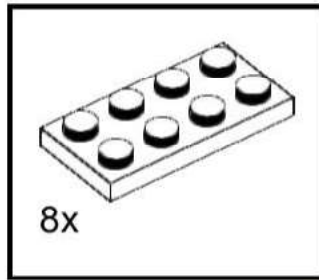

225

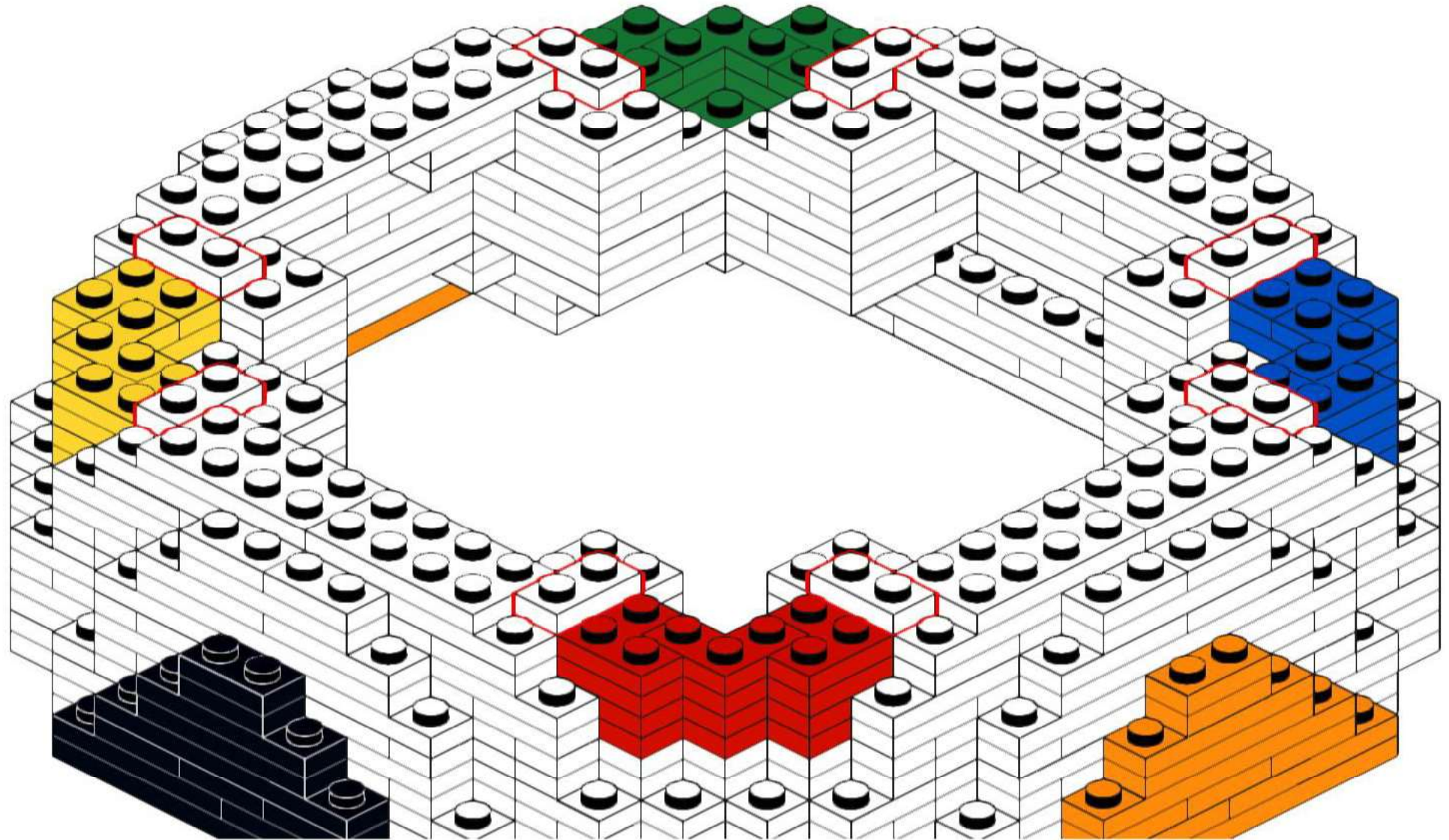
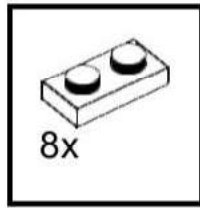

226

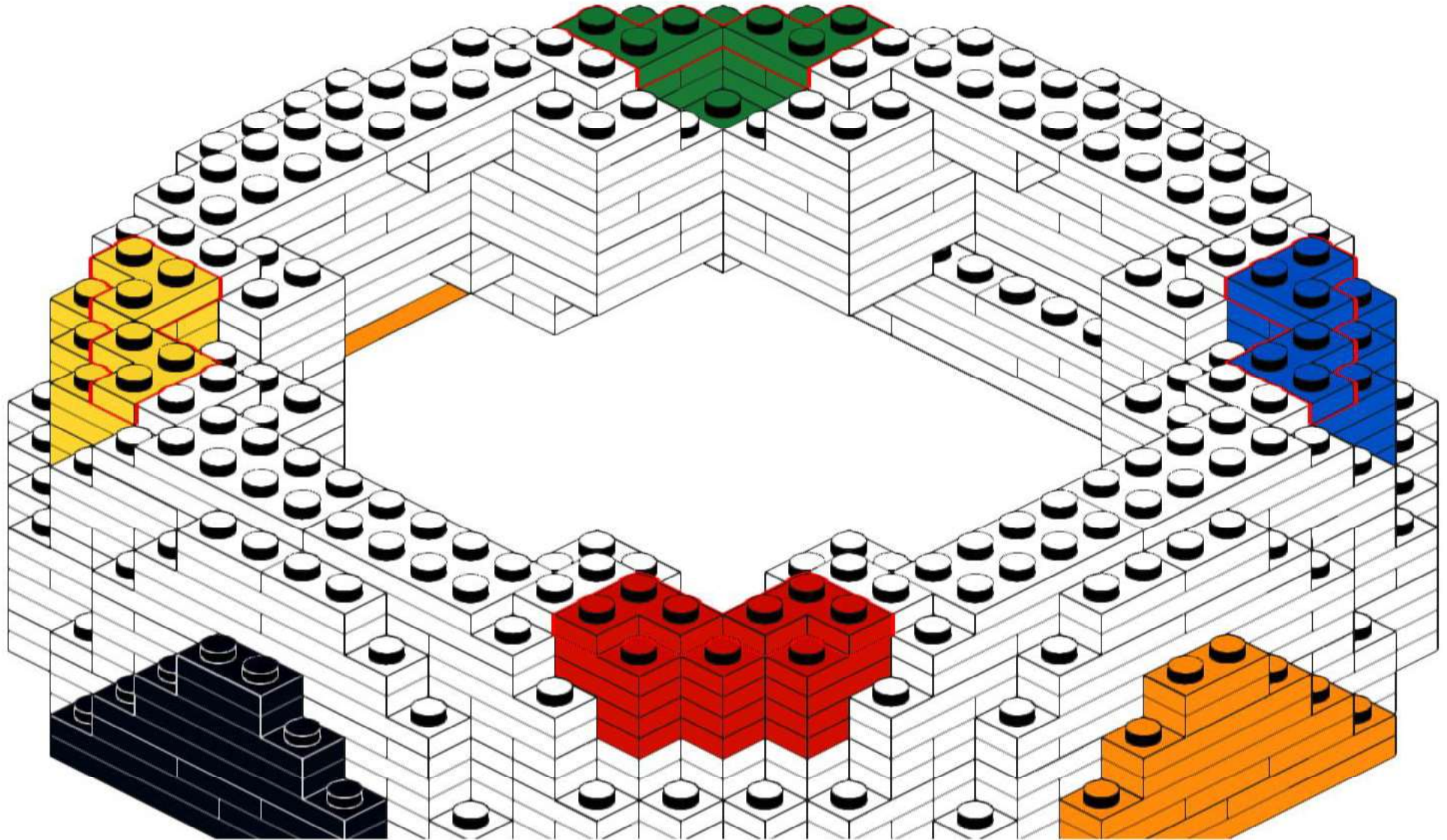
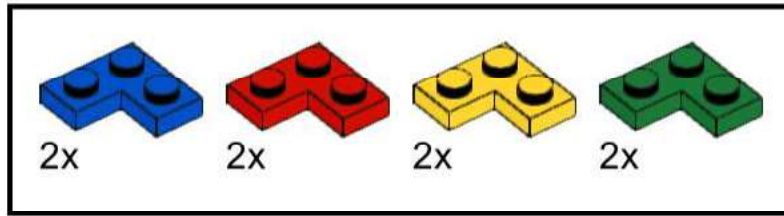

227

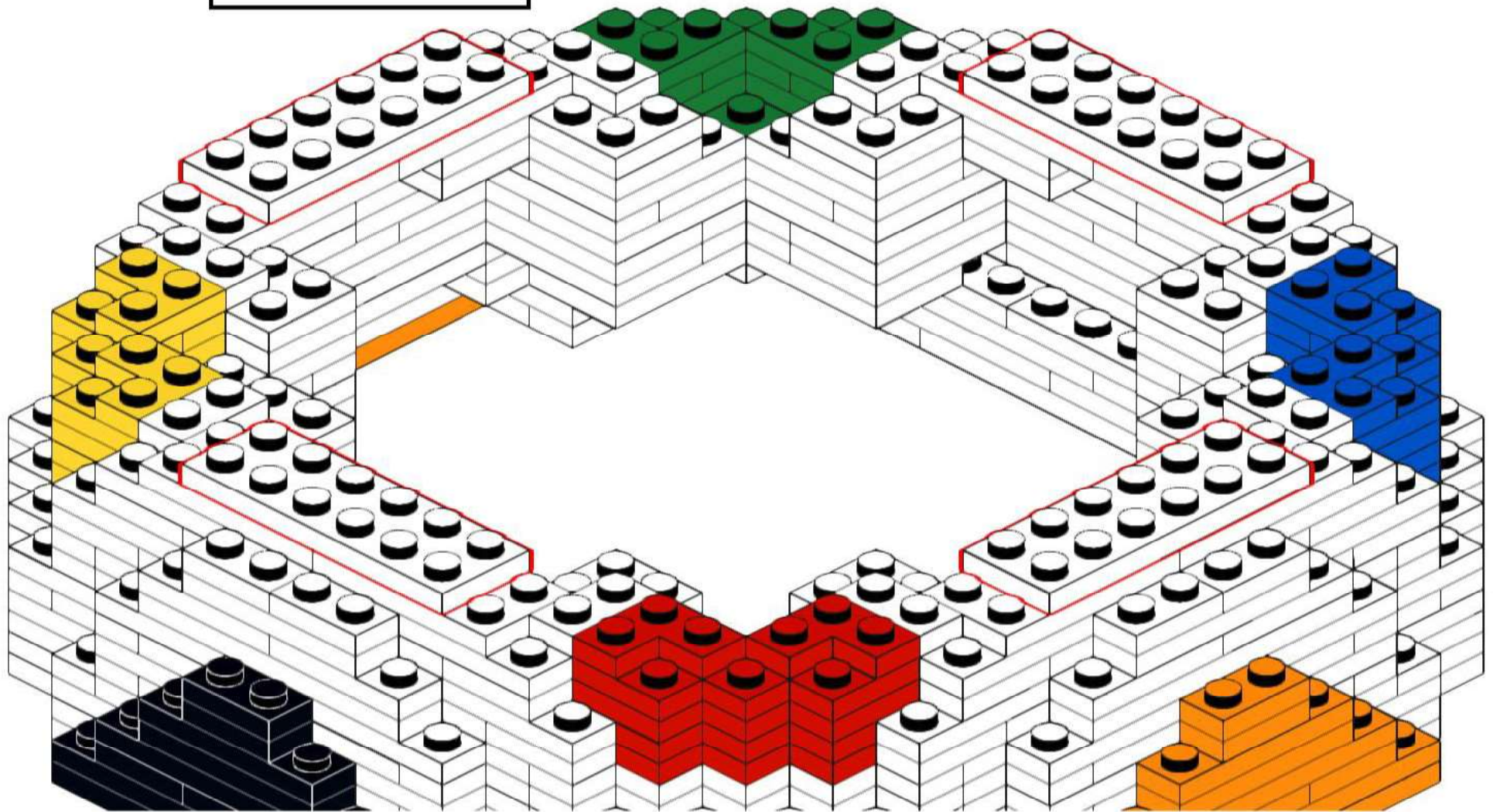
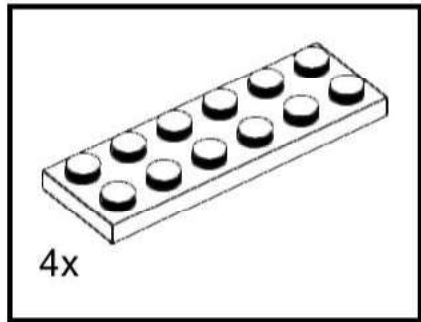

228

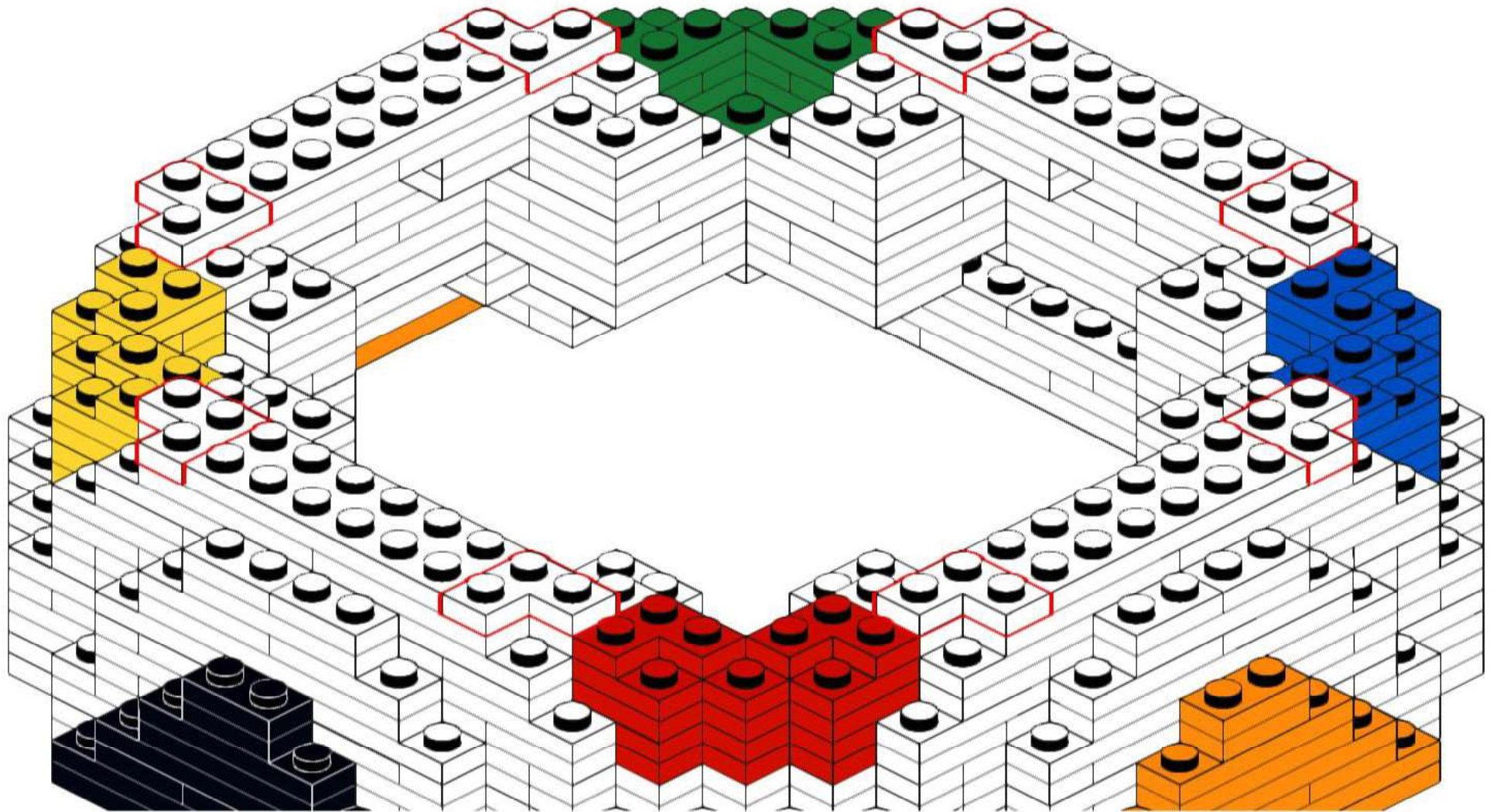
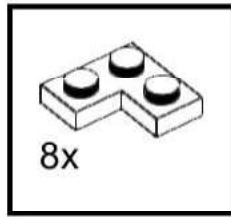

229

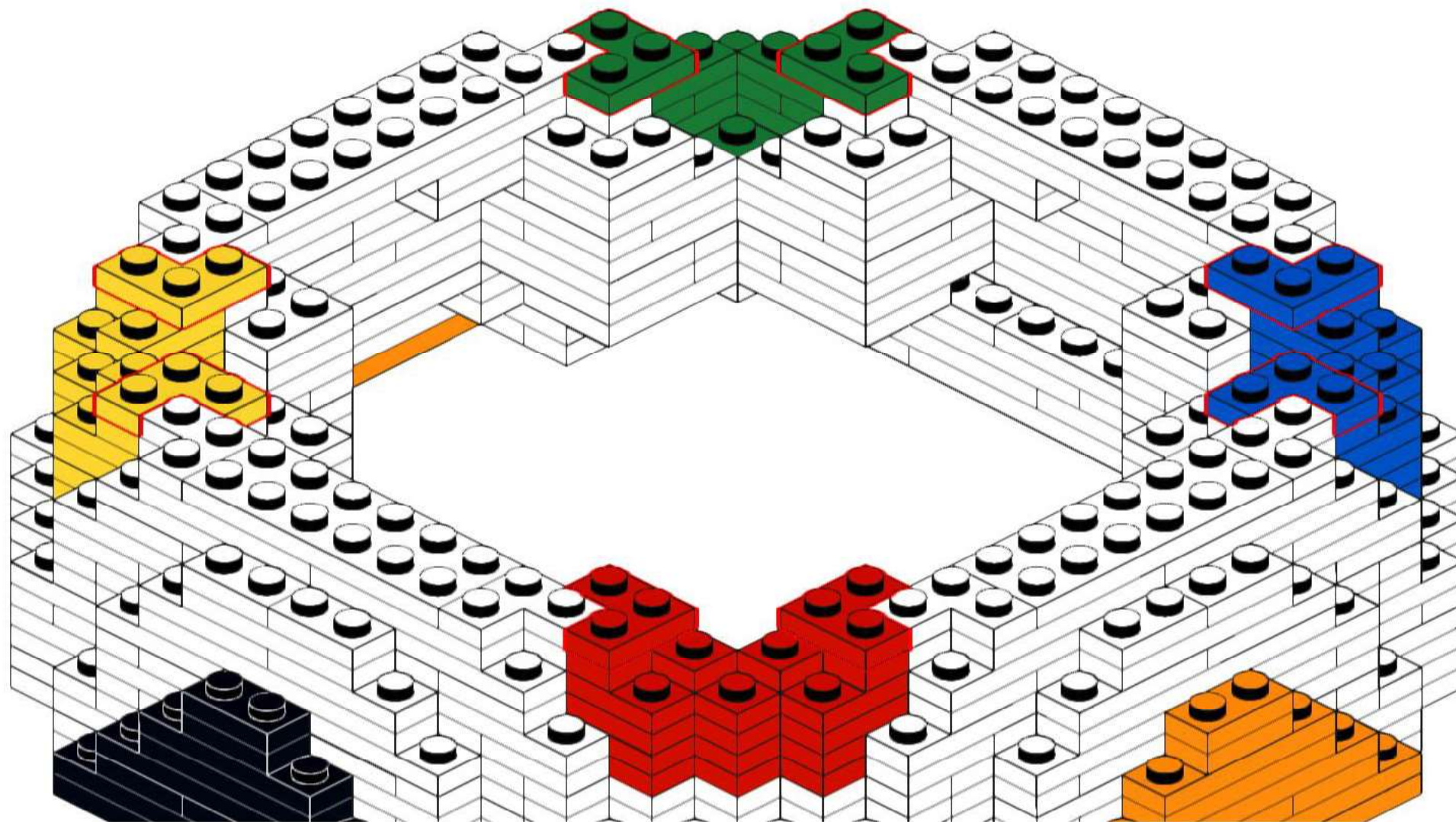
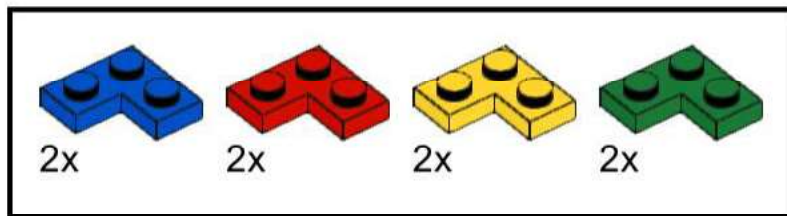

230

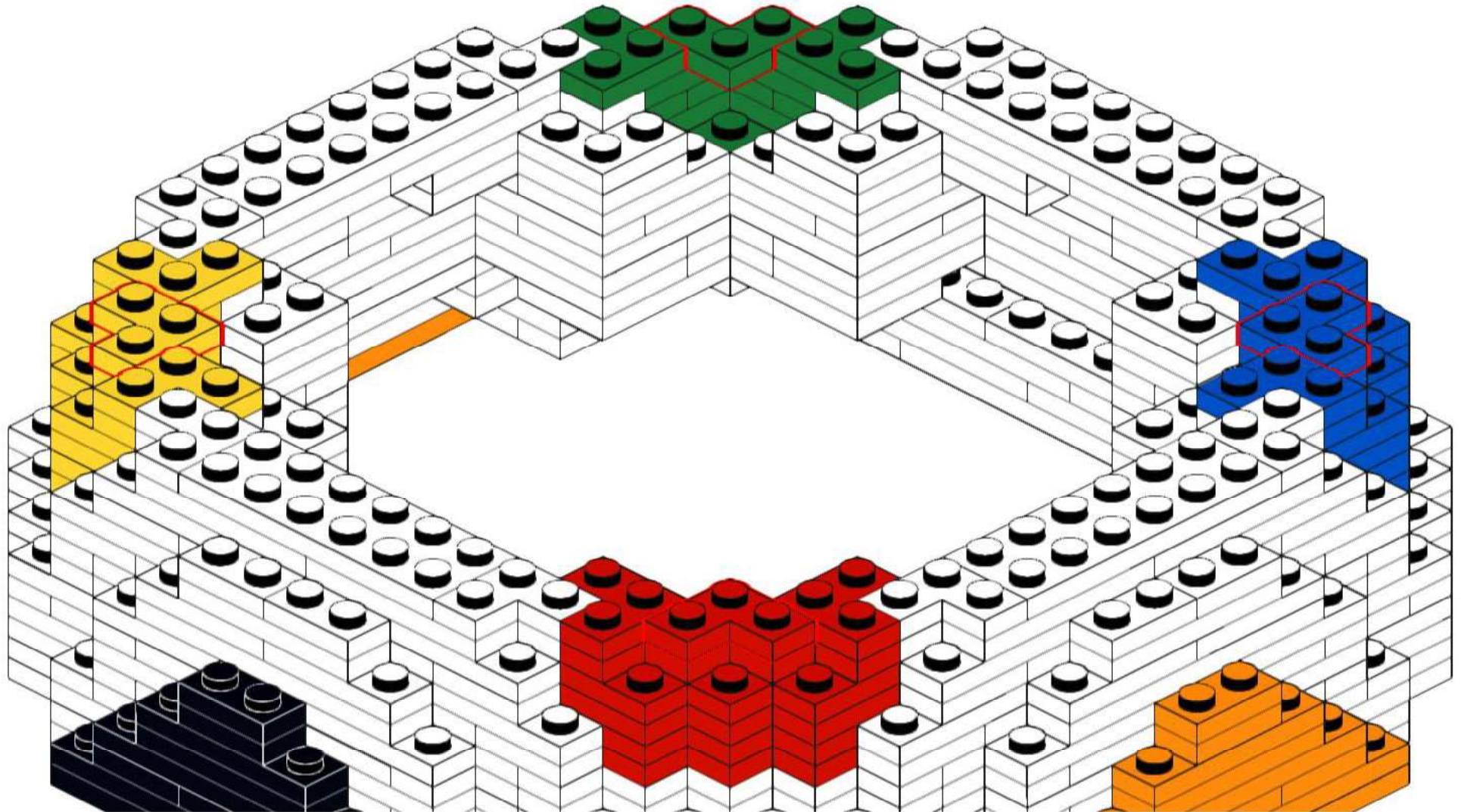
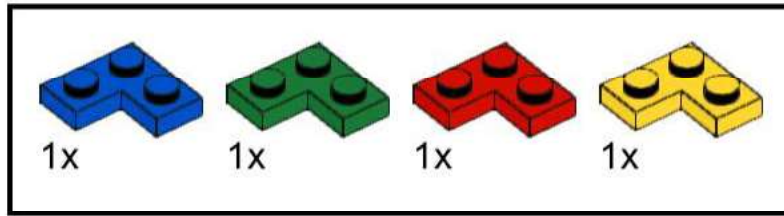

231

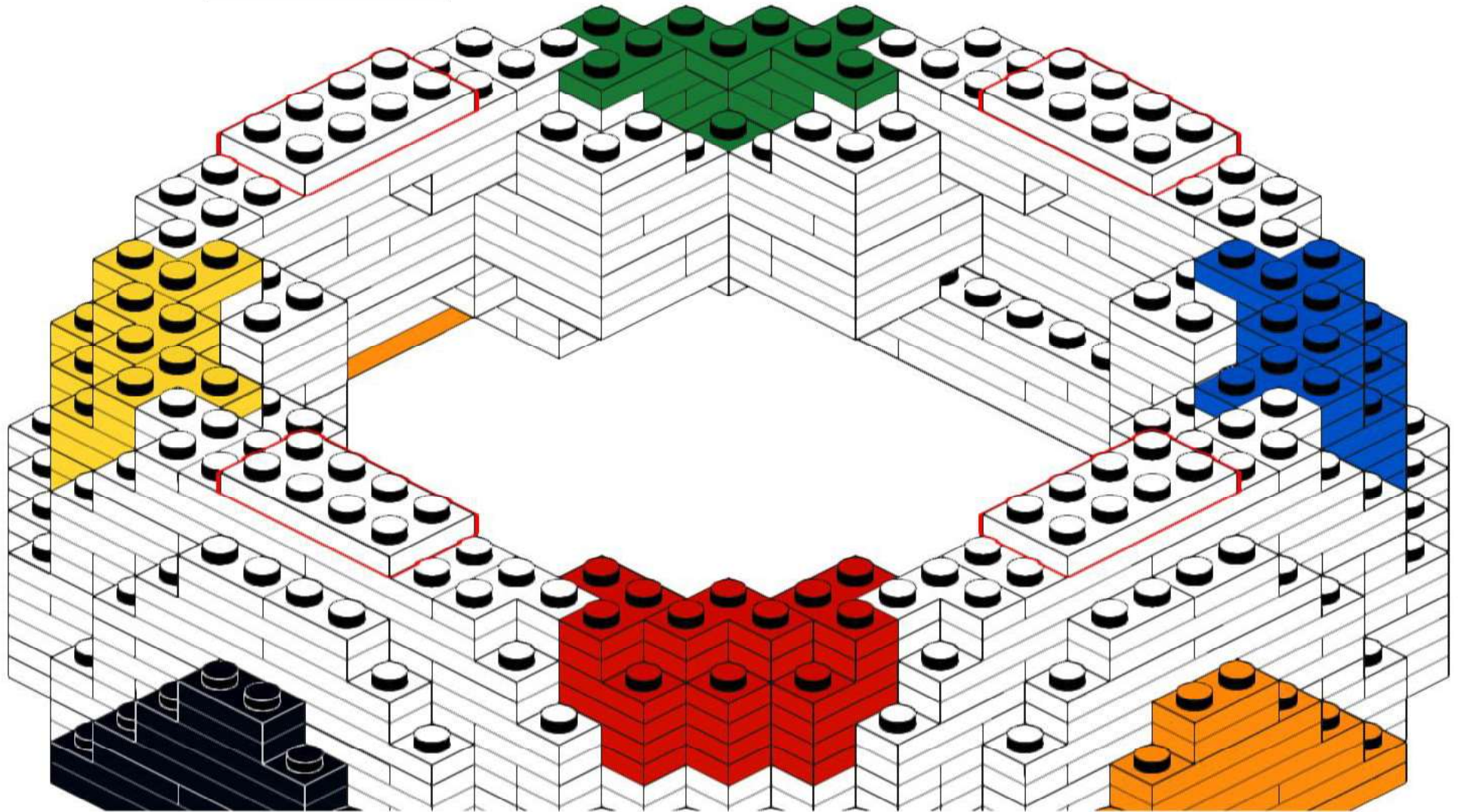
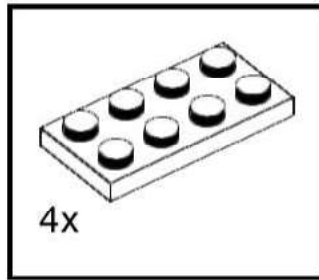

232

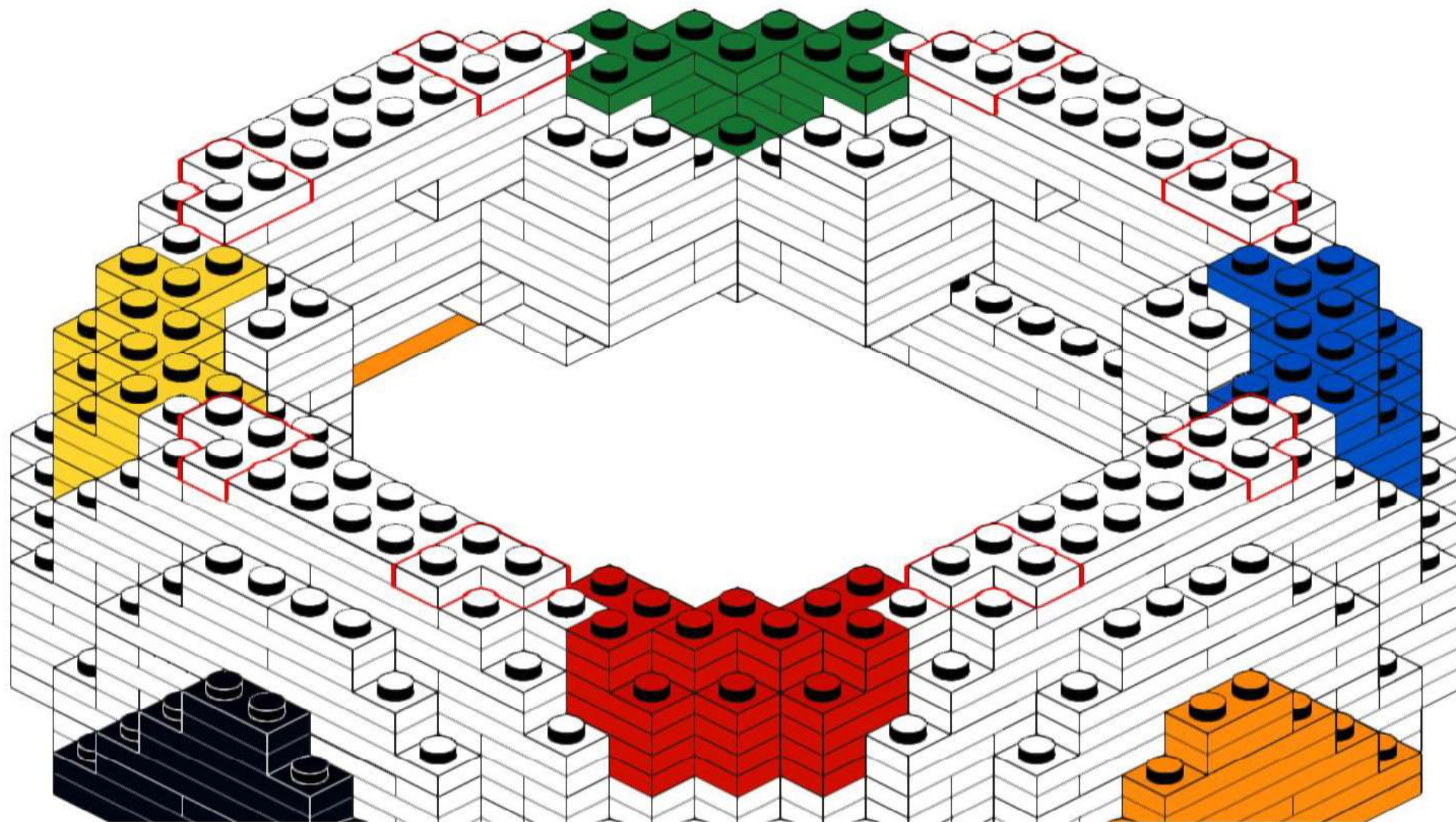
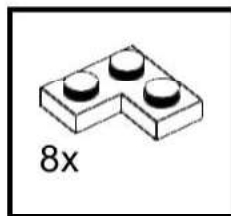

233

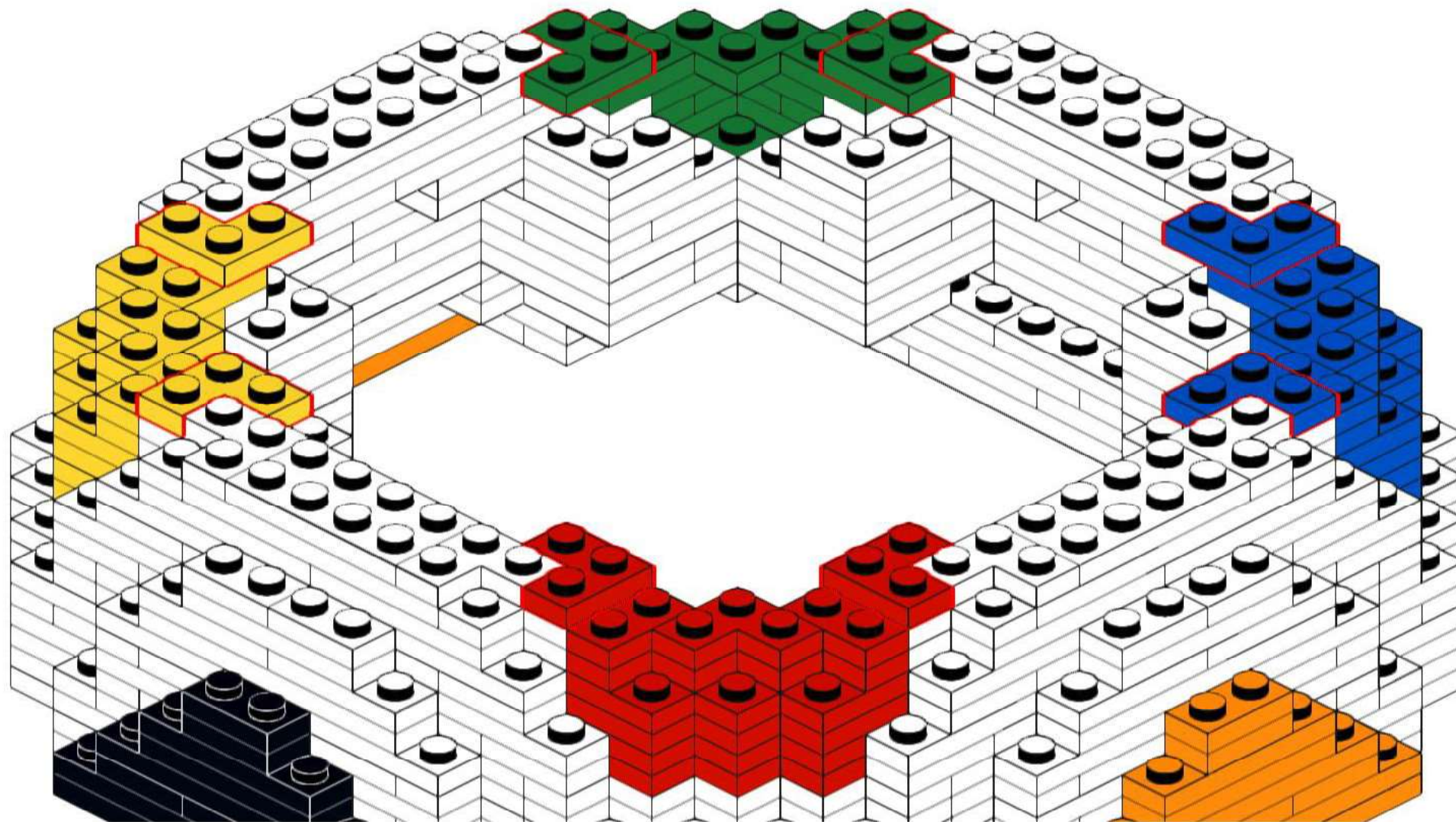
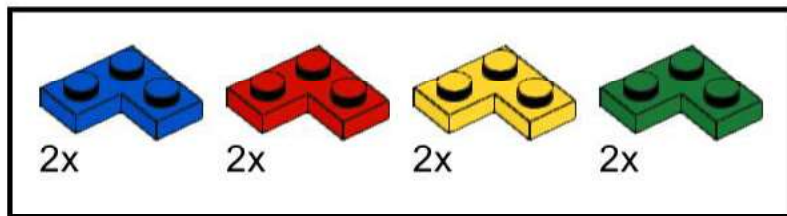

234

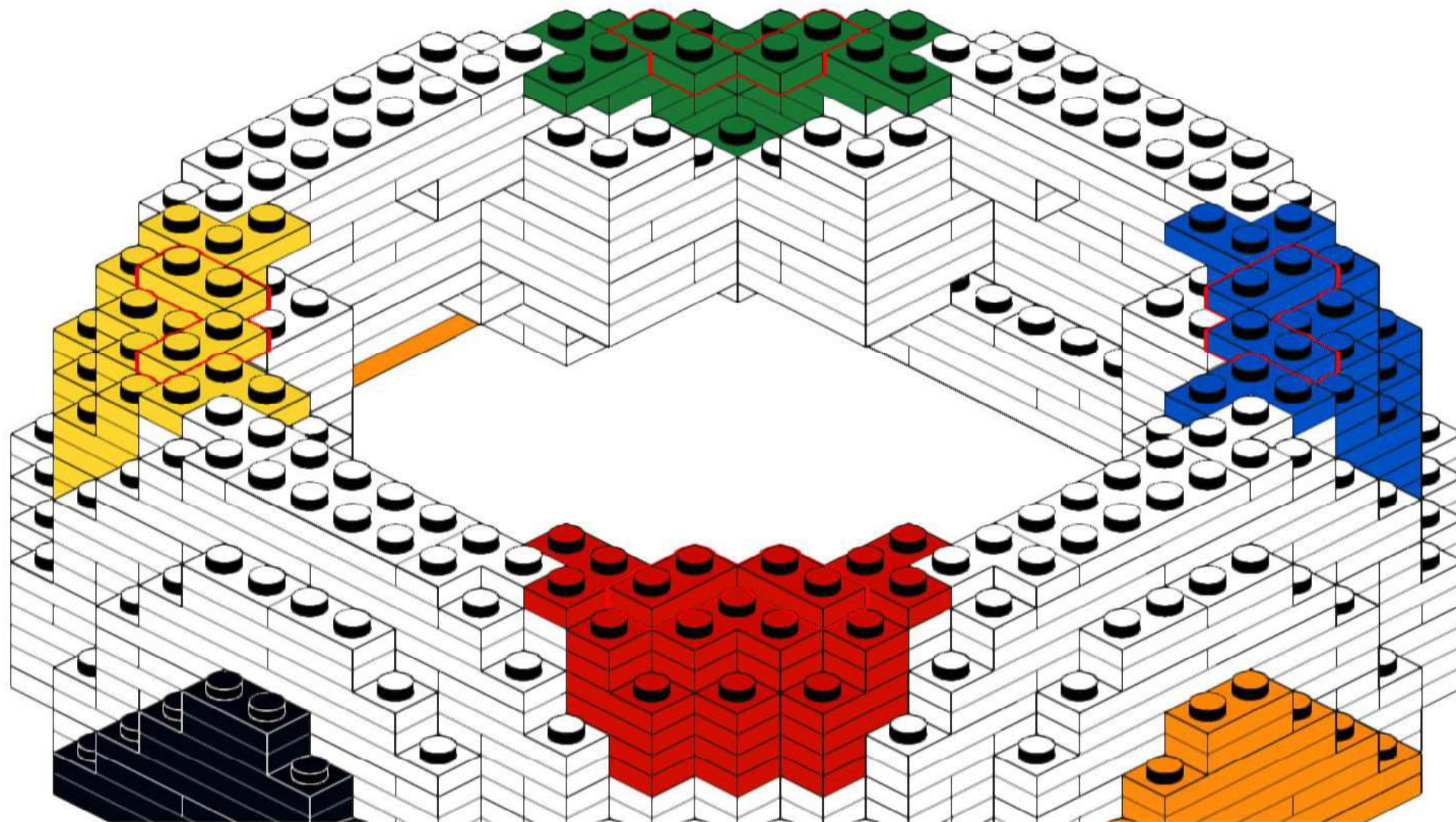
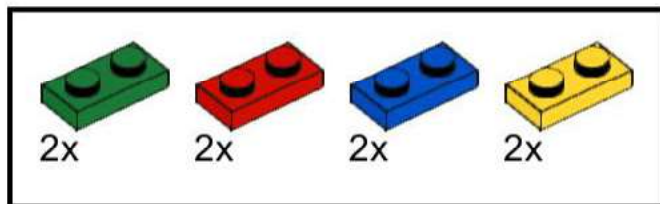

235

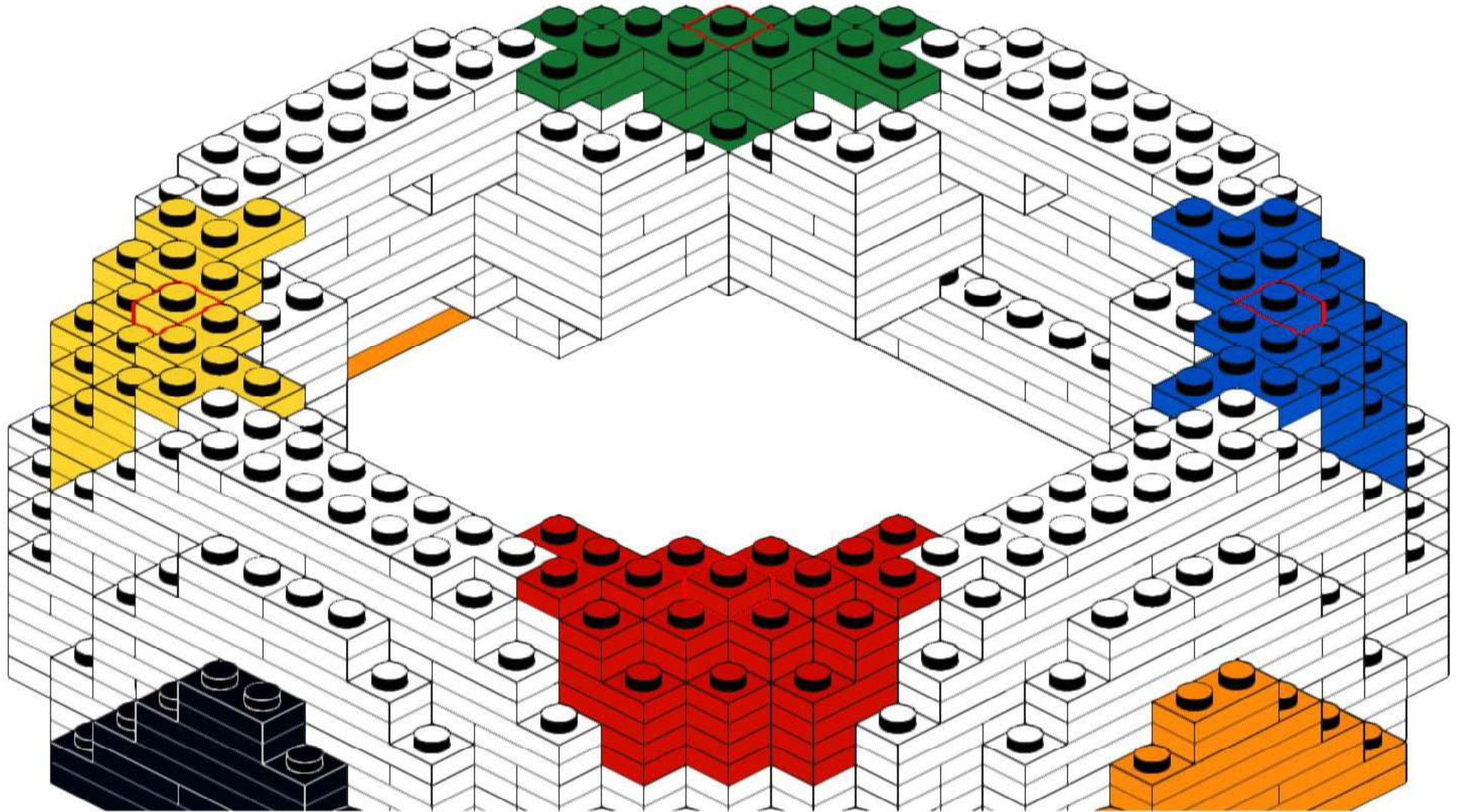
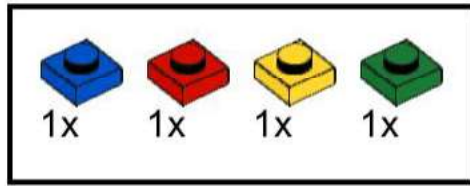

236

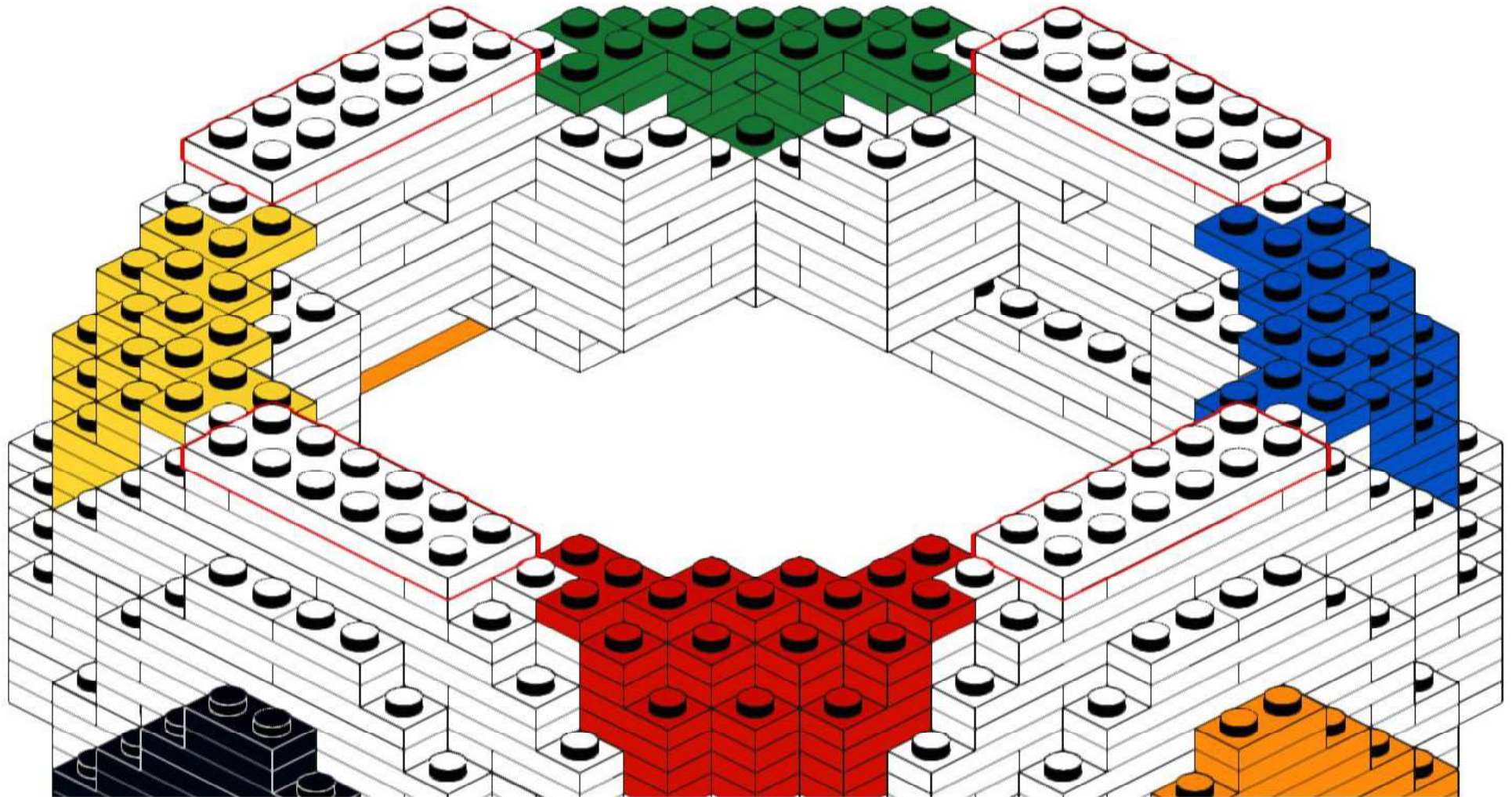
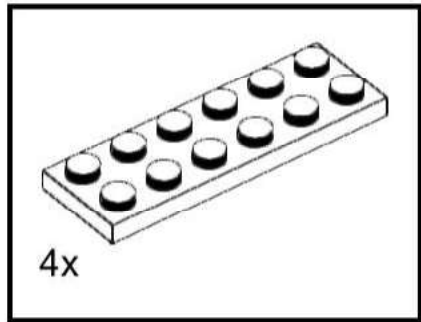

237

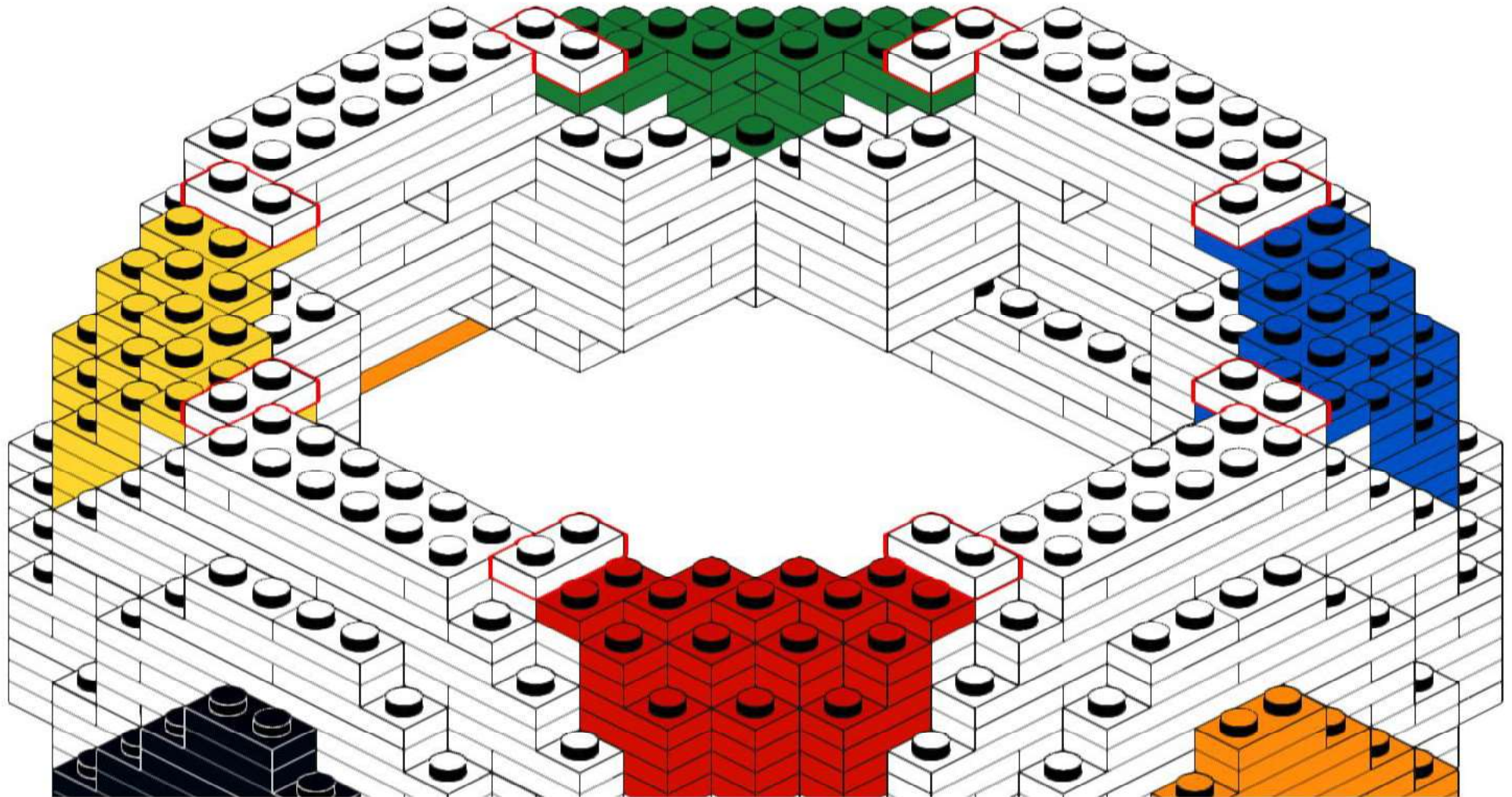
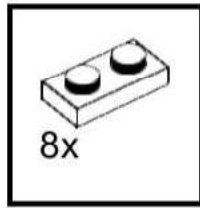

238

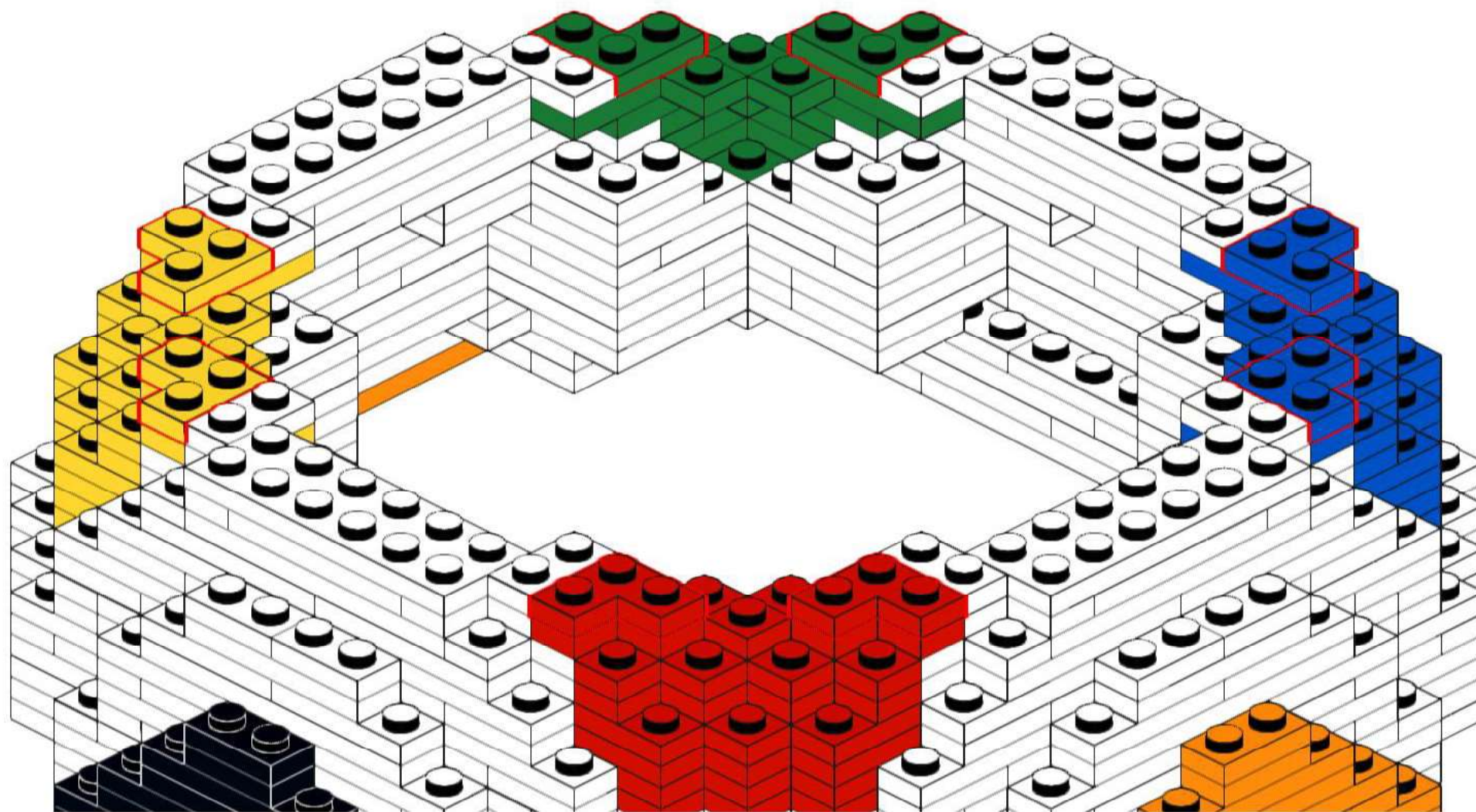
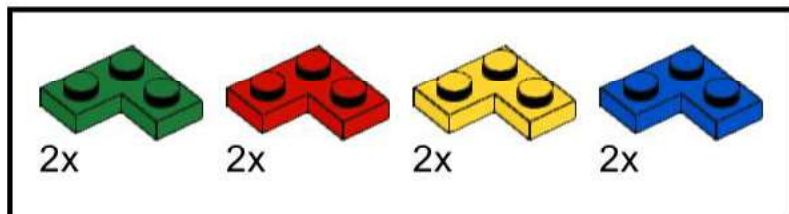

239

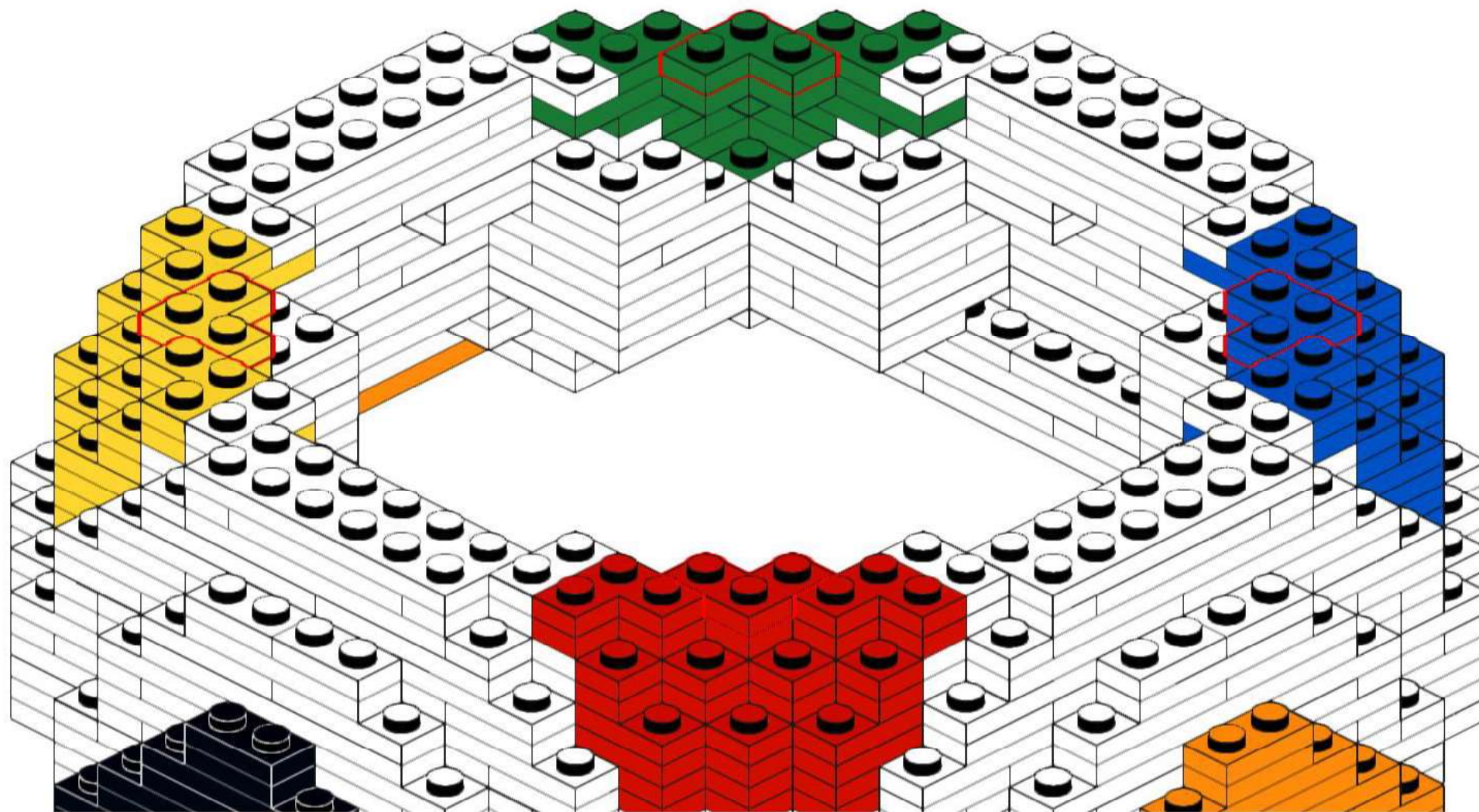
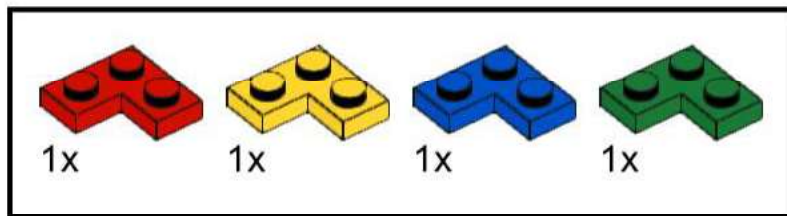

240

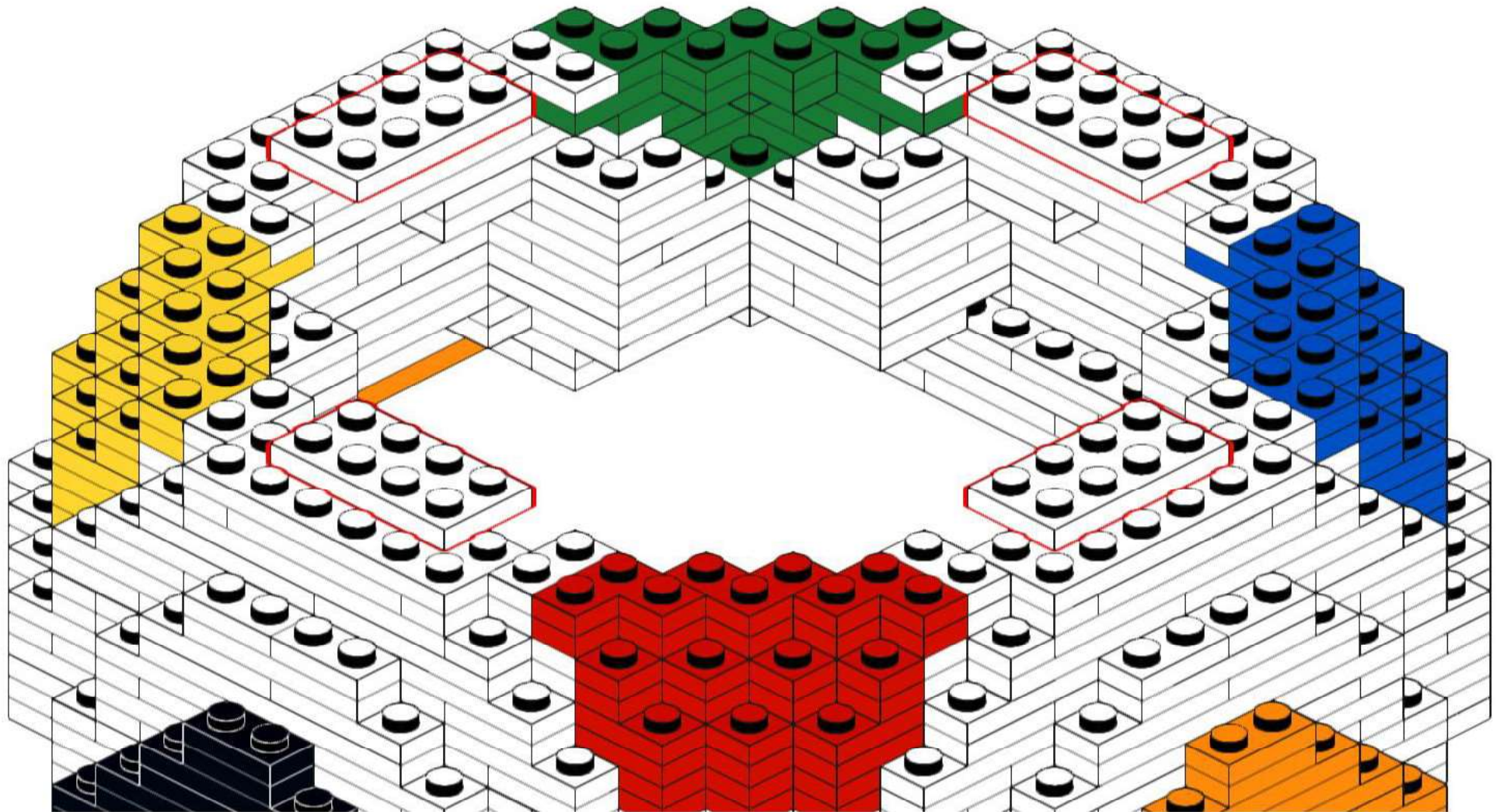
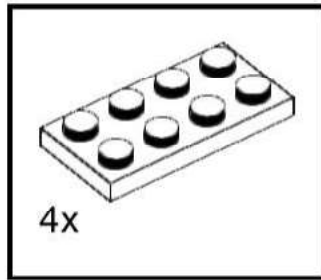

241

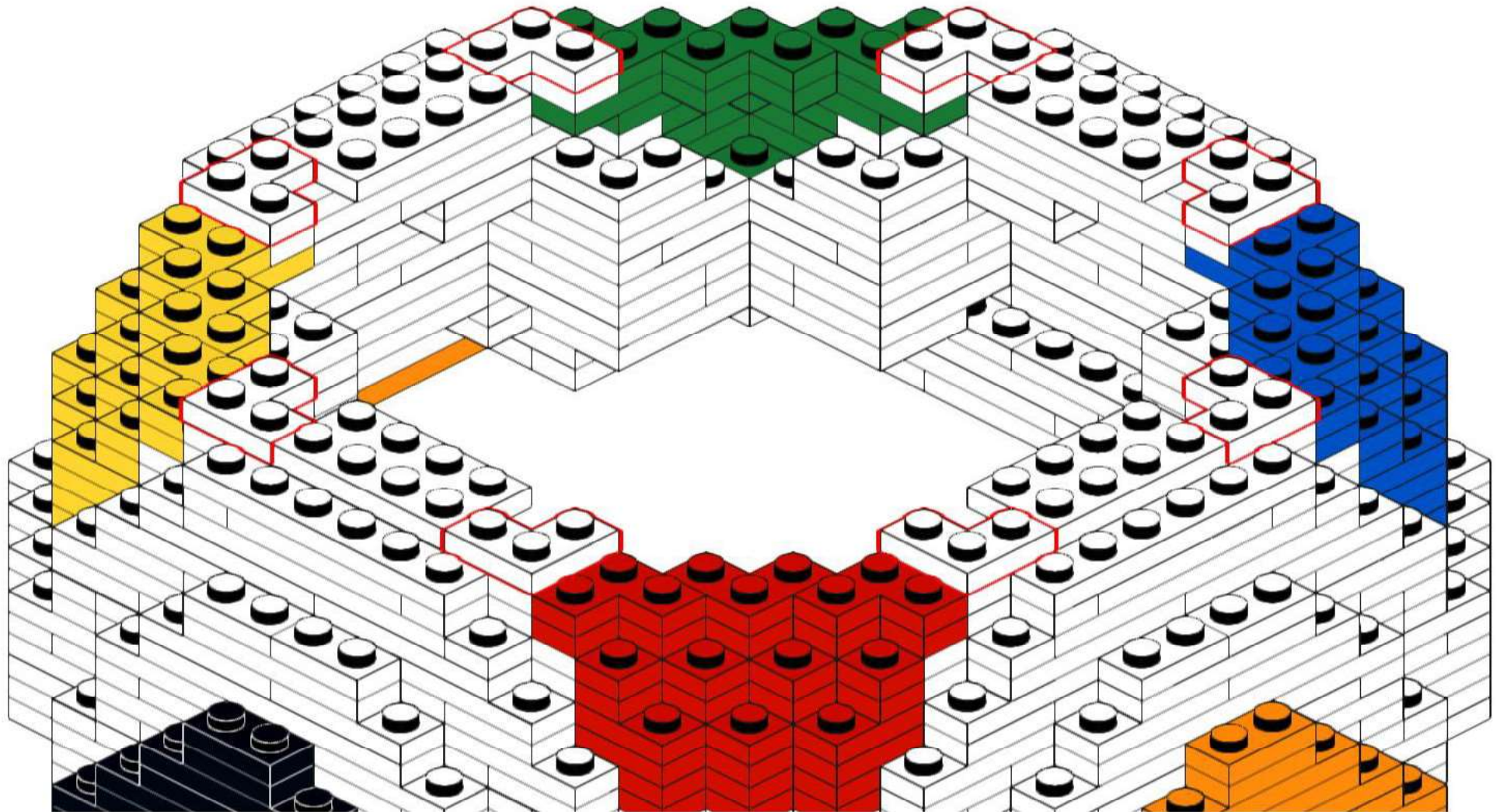
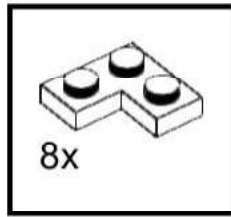

242

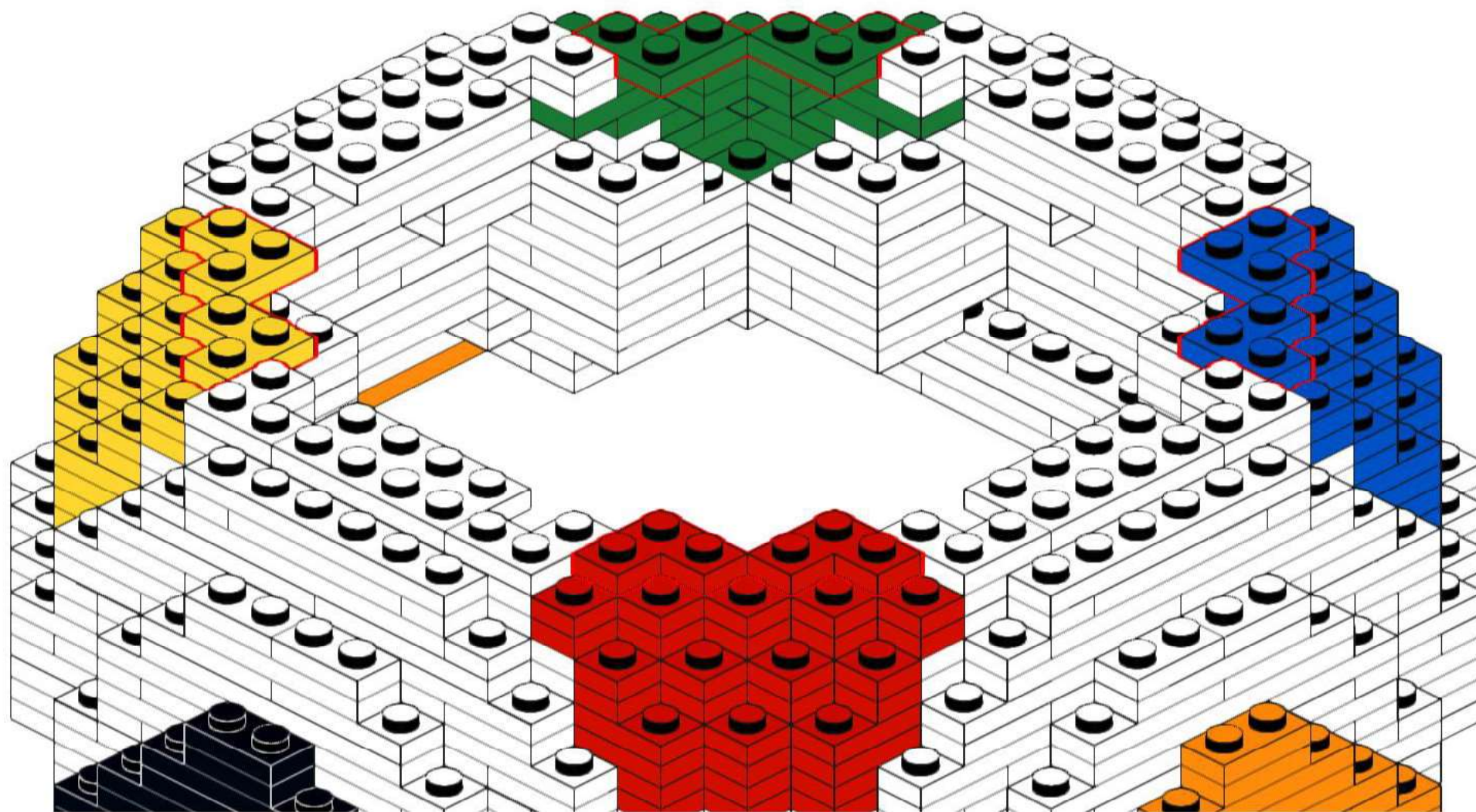
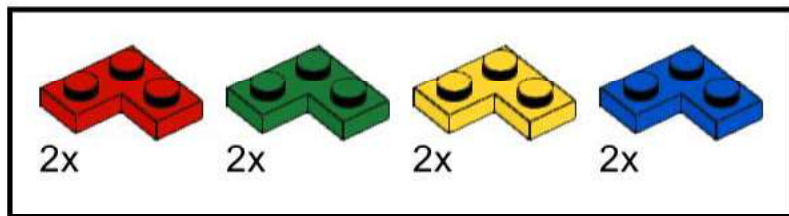

243

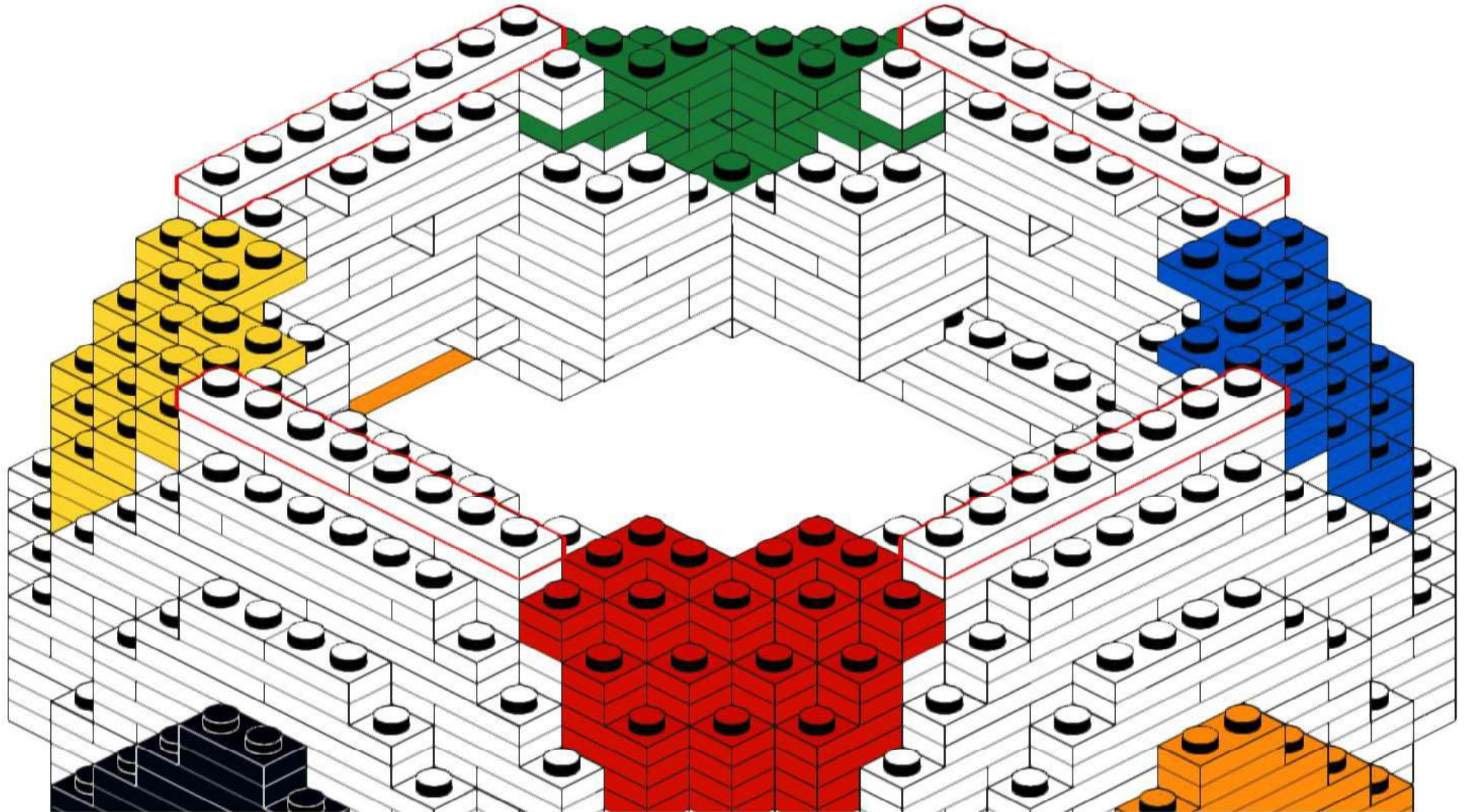
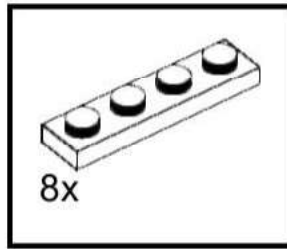

244

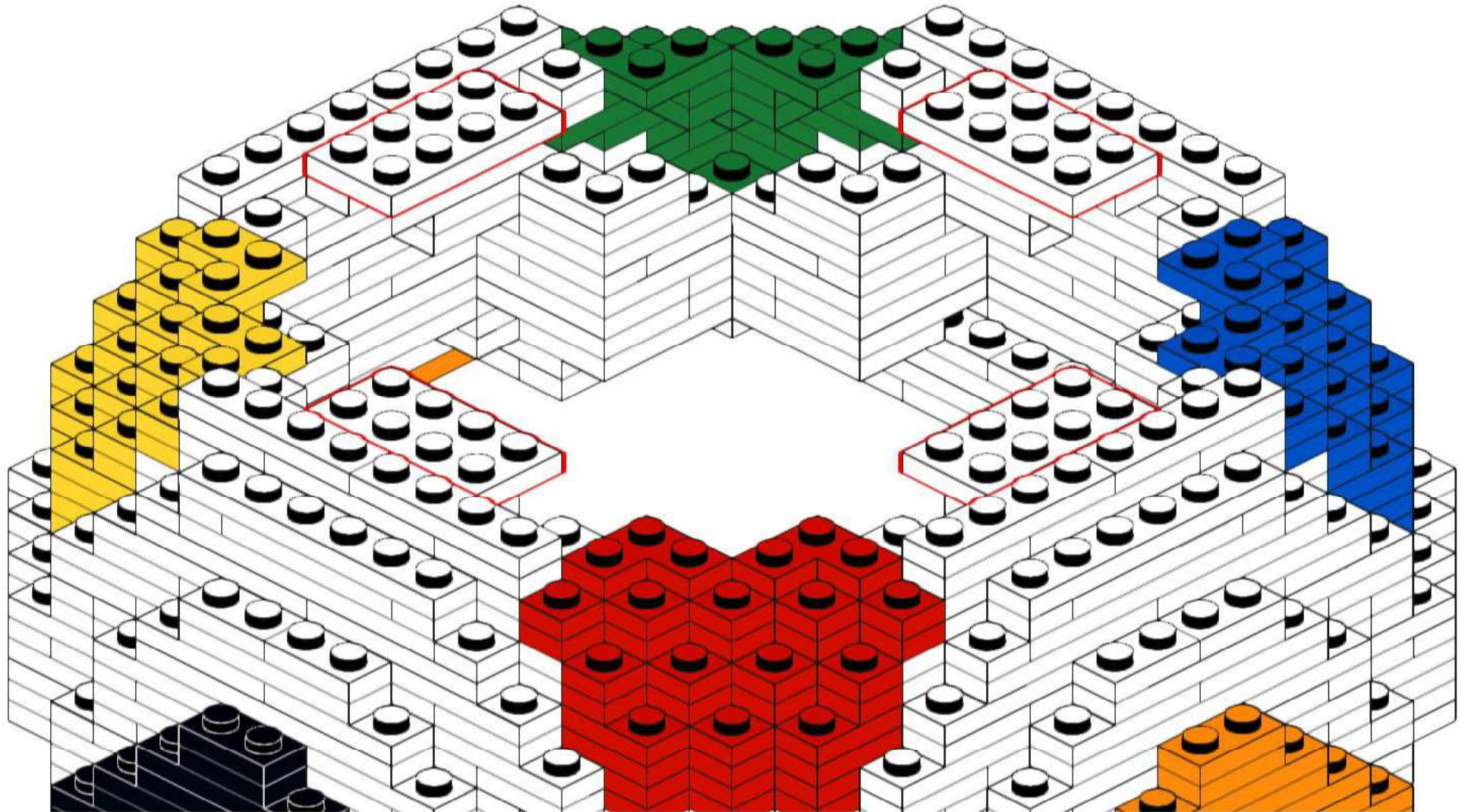
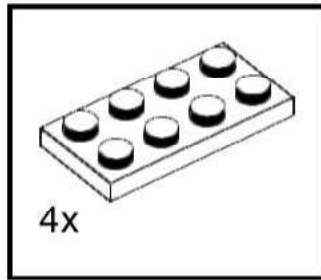

245

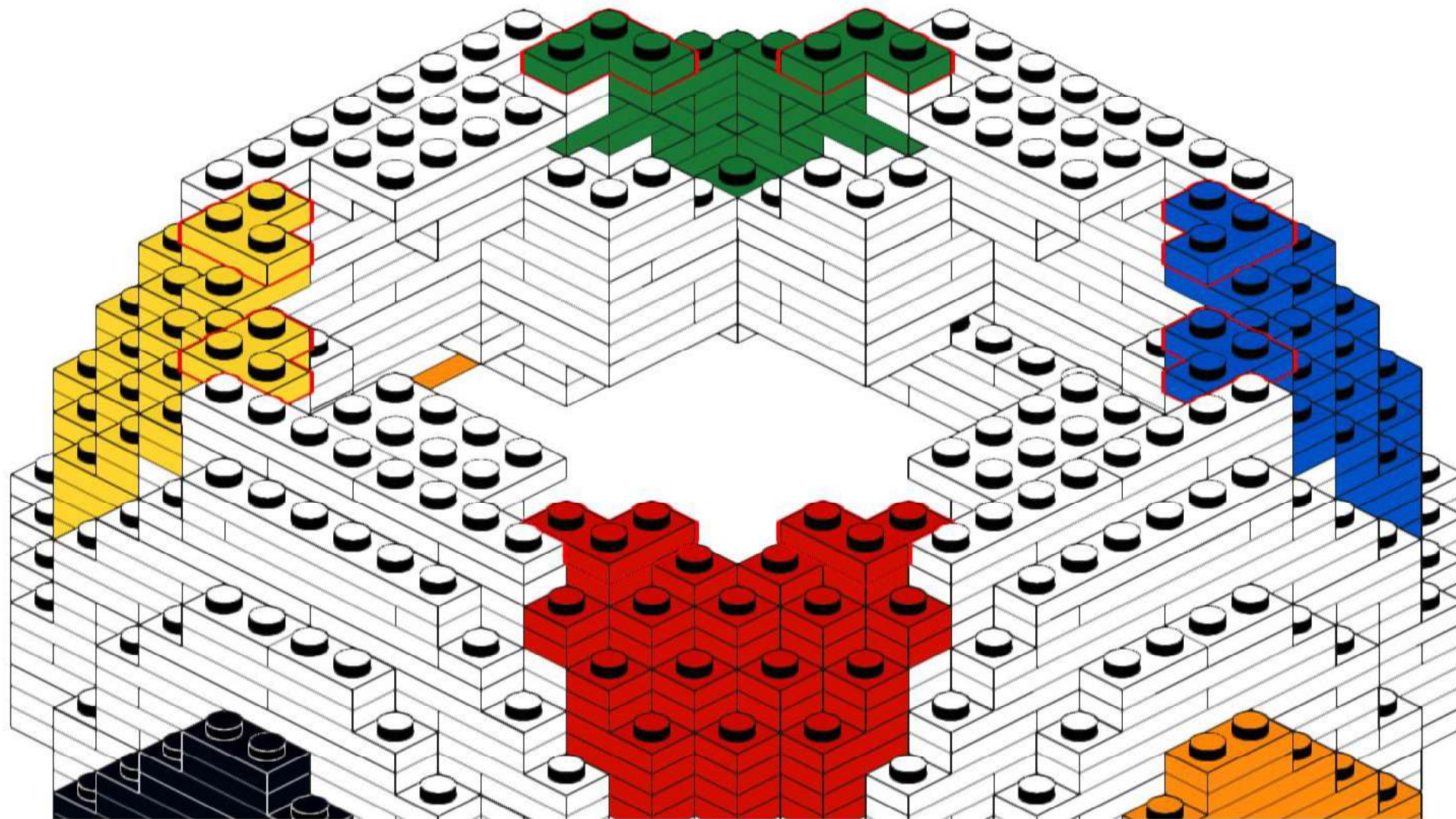
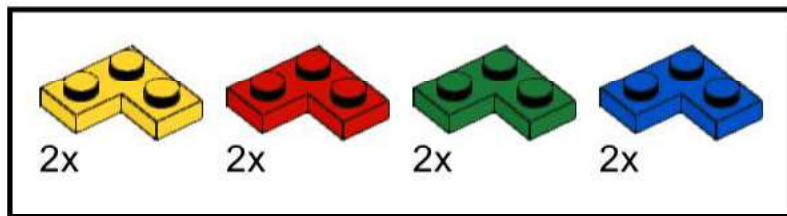

246

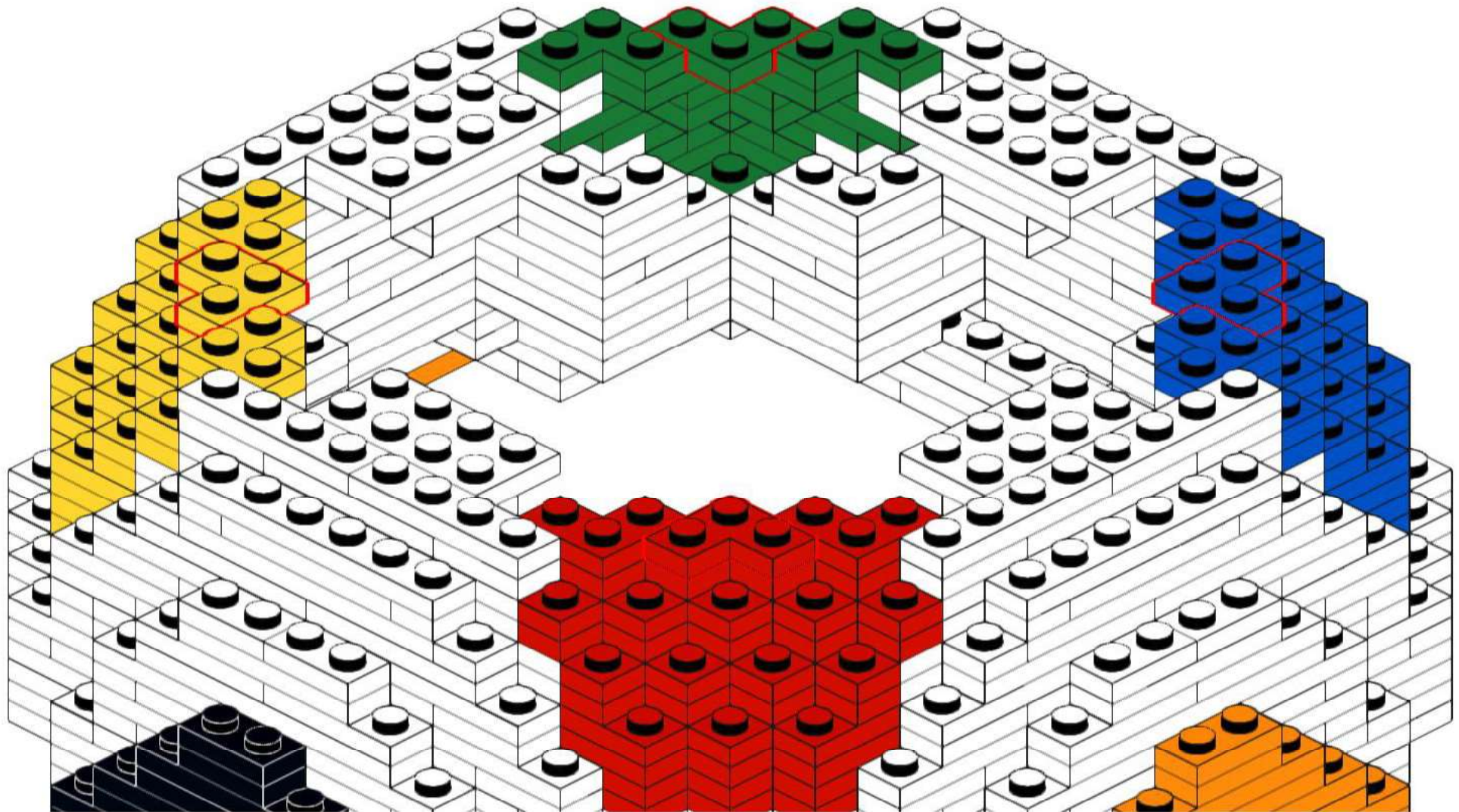
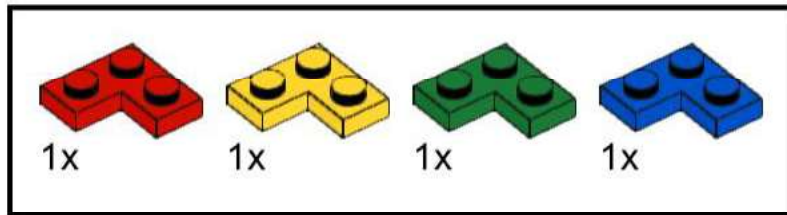

247

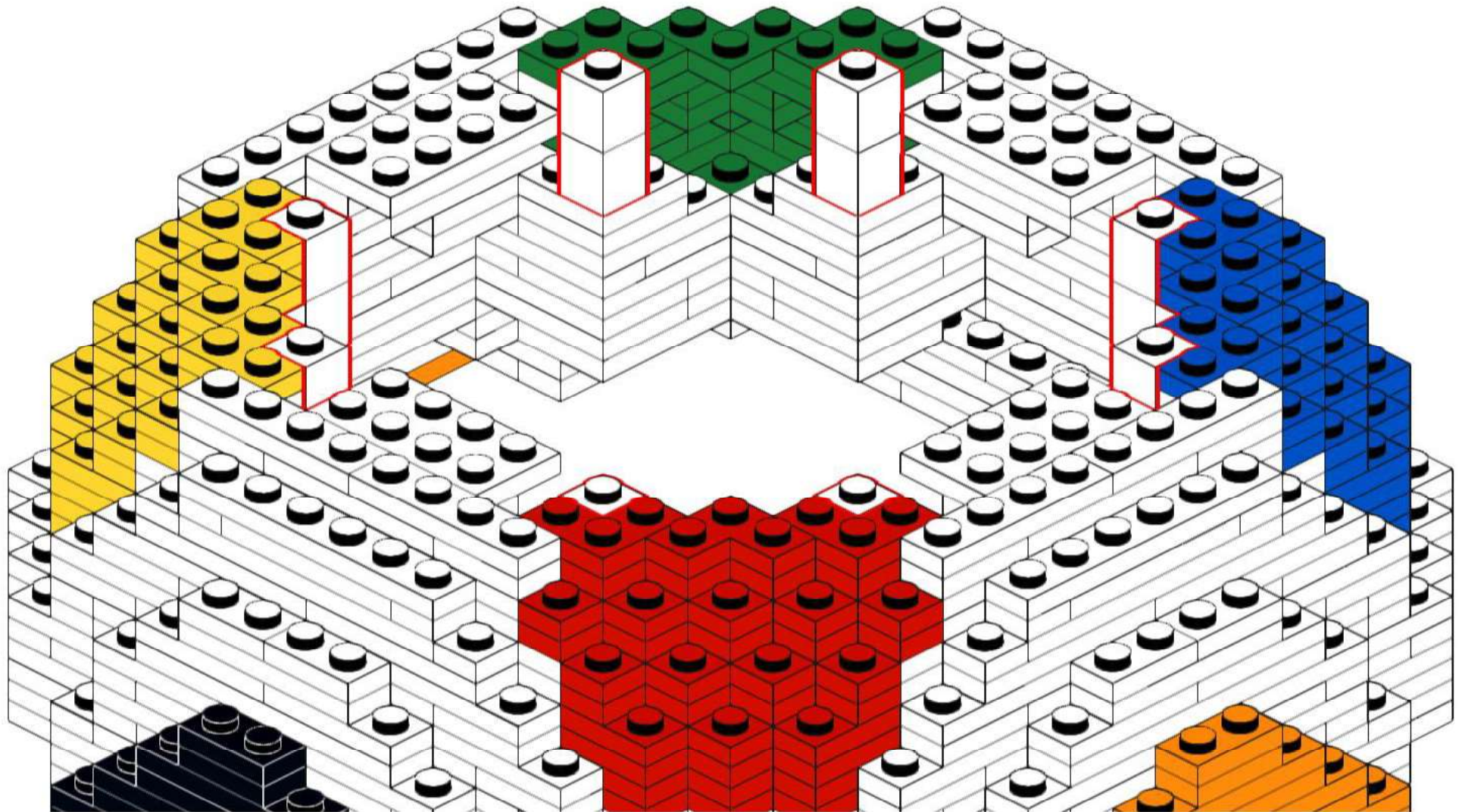
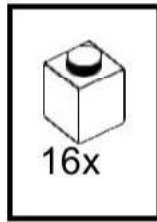

248

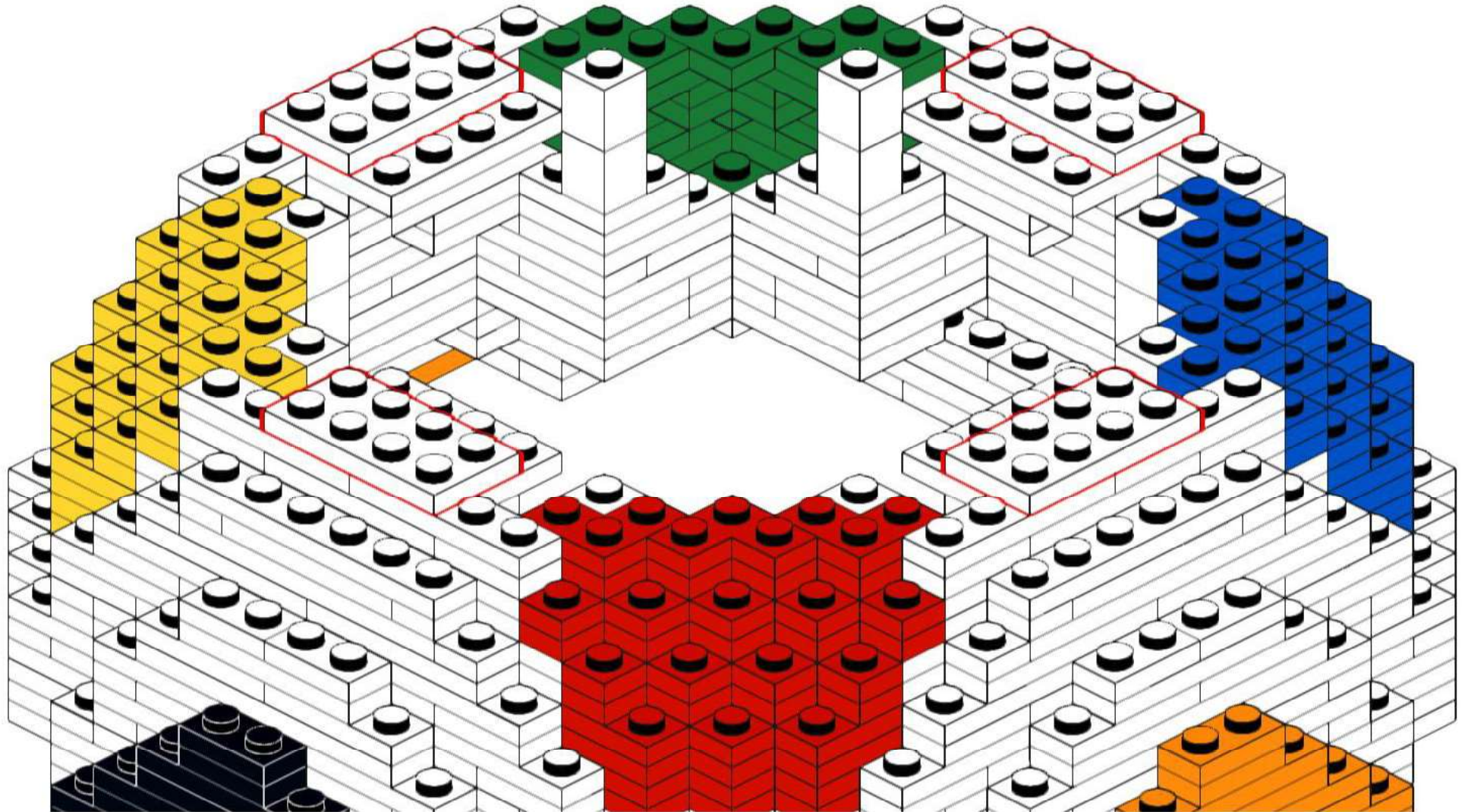
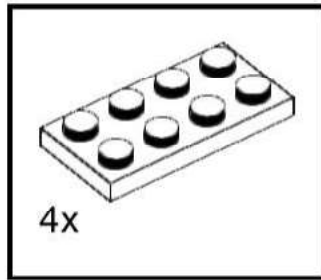

249

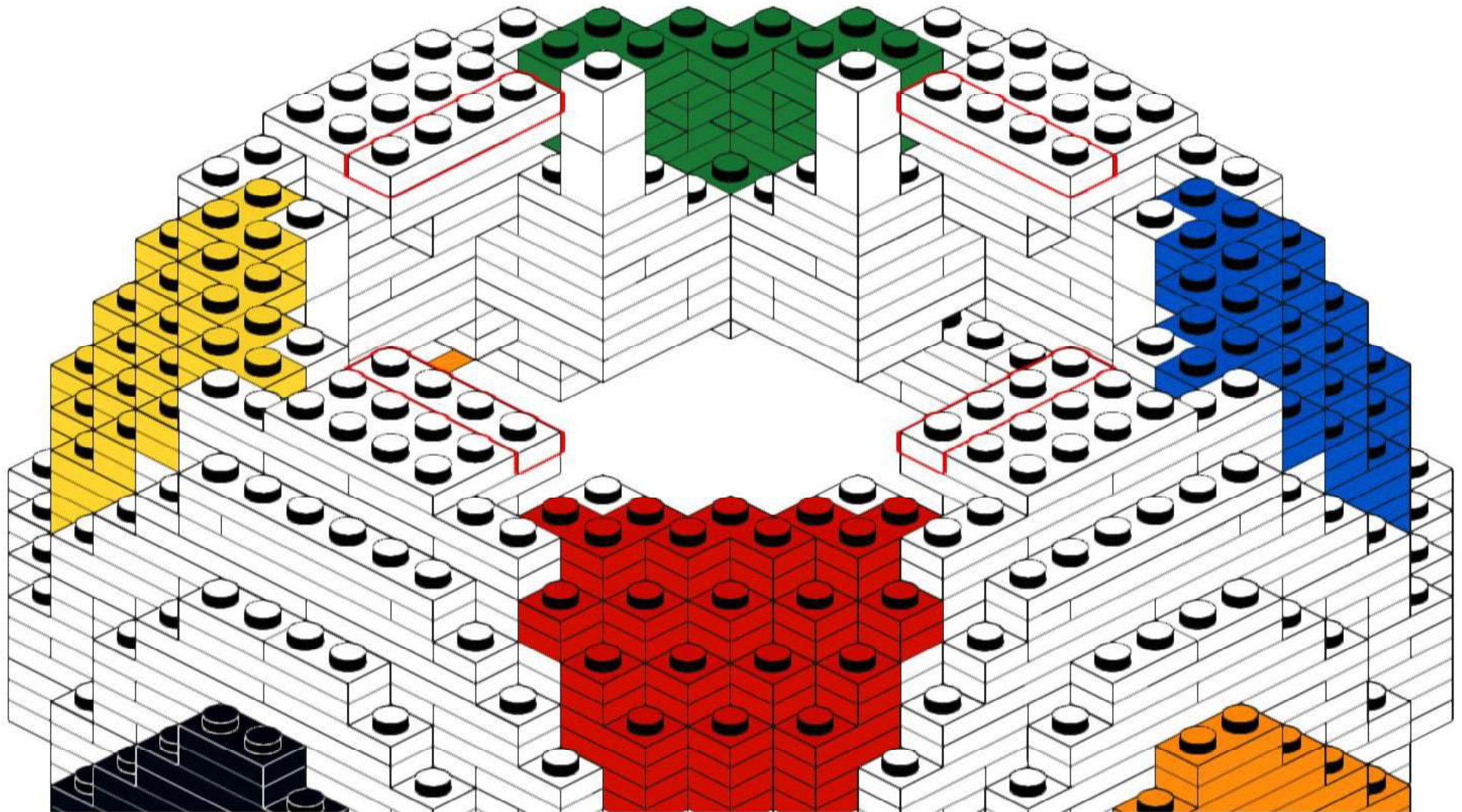
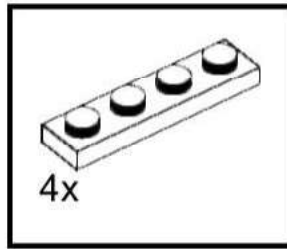

250

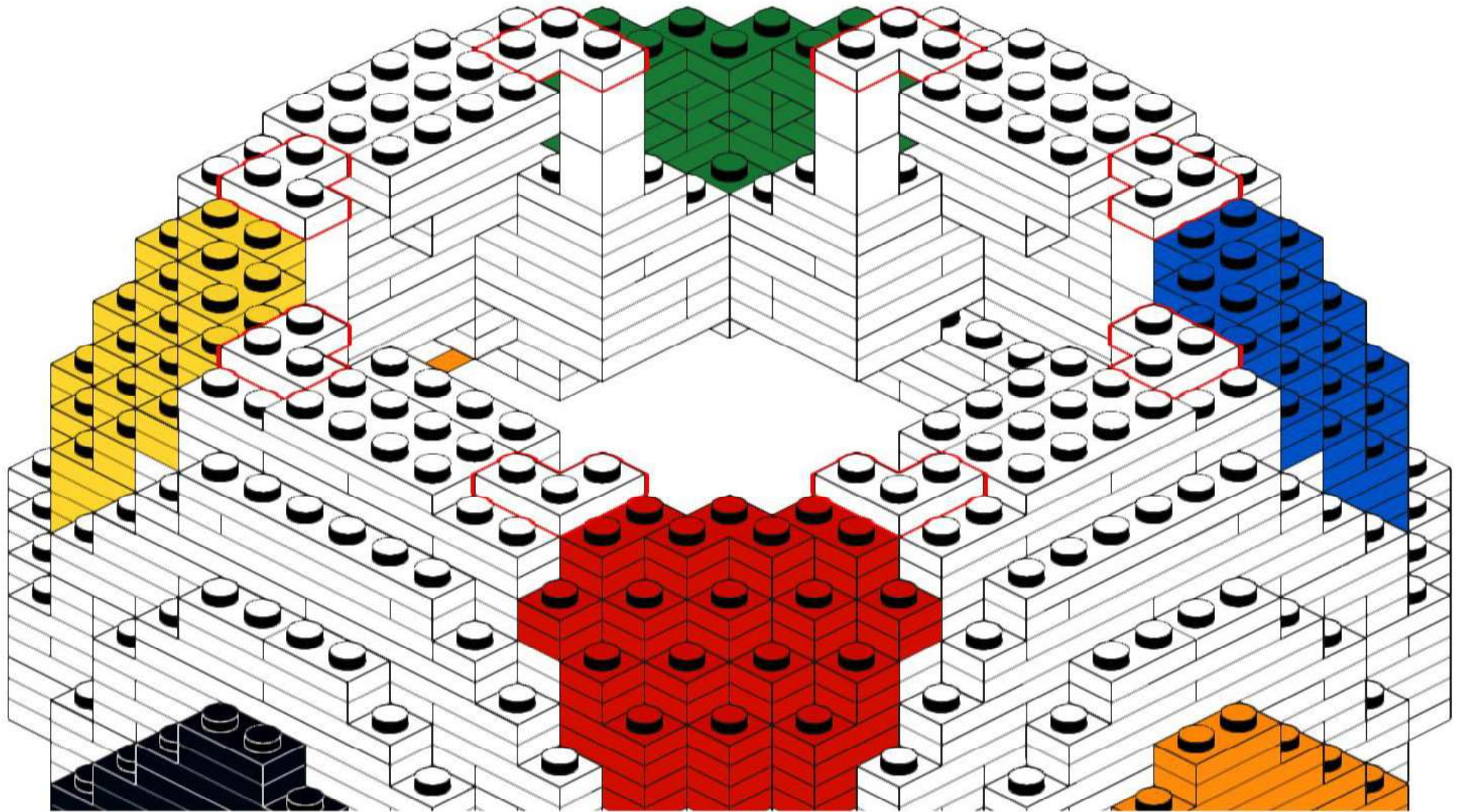
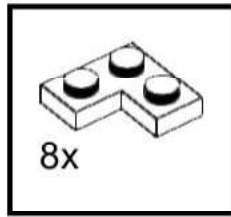

251

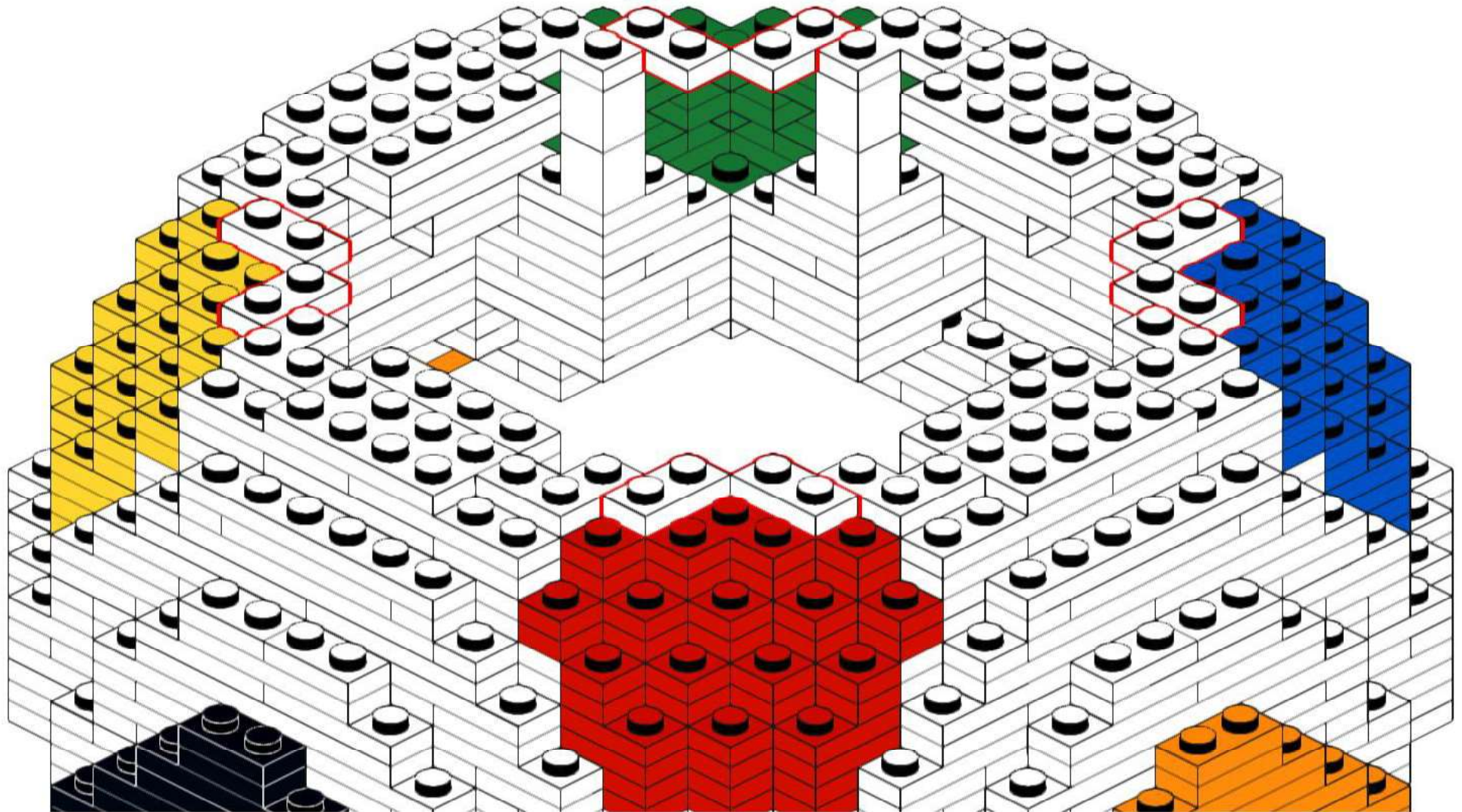
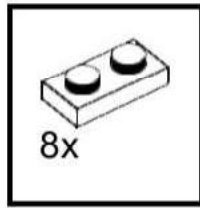

252

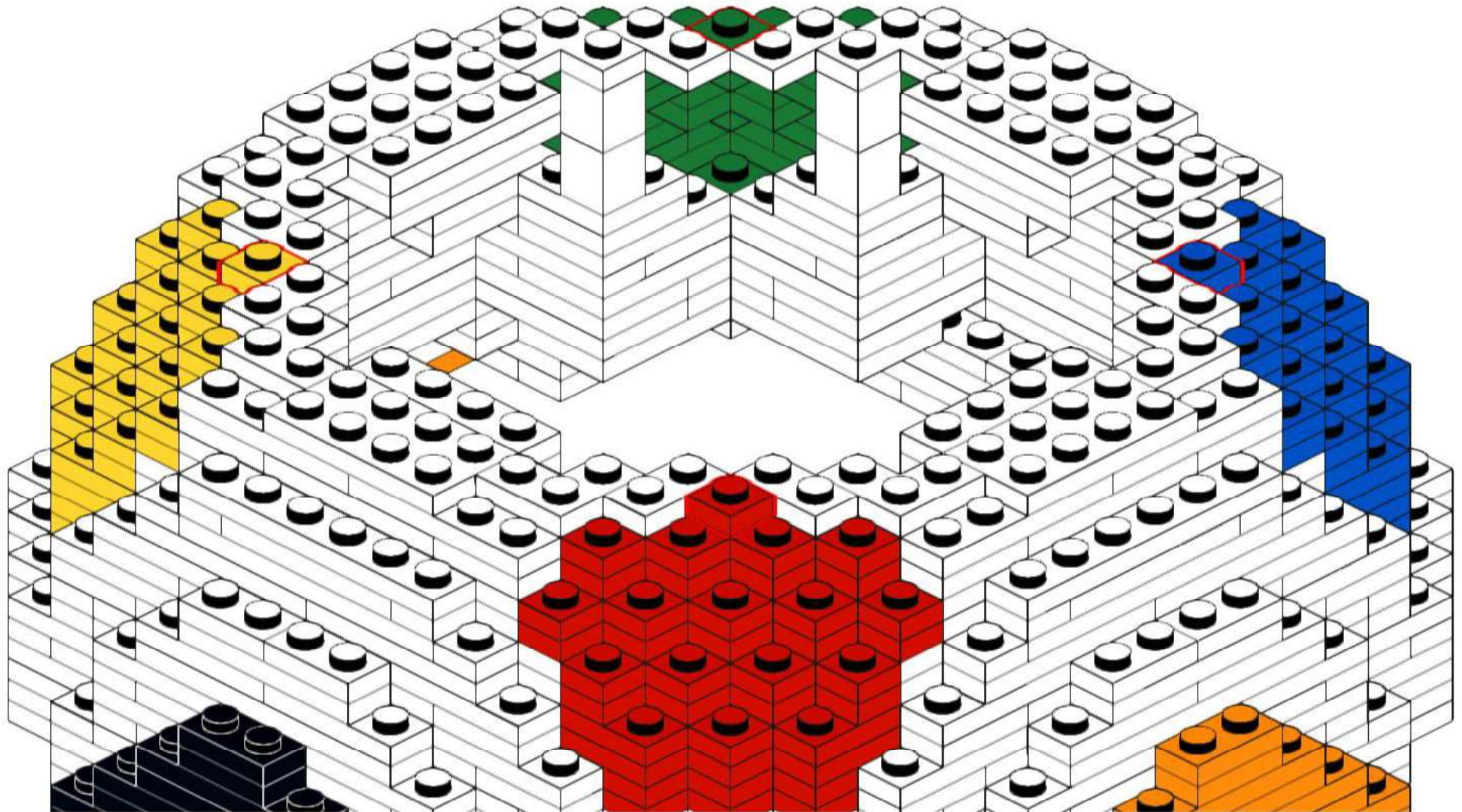
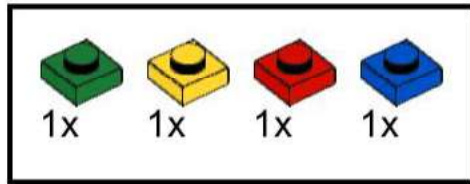

253

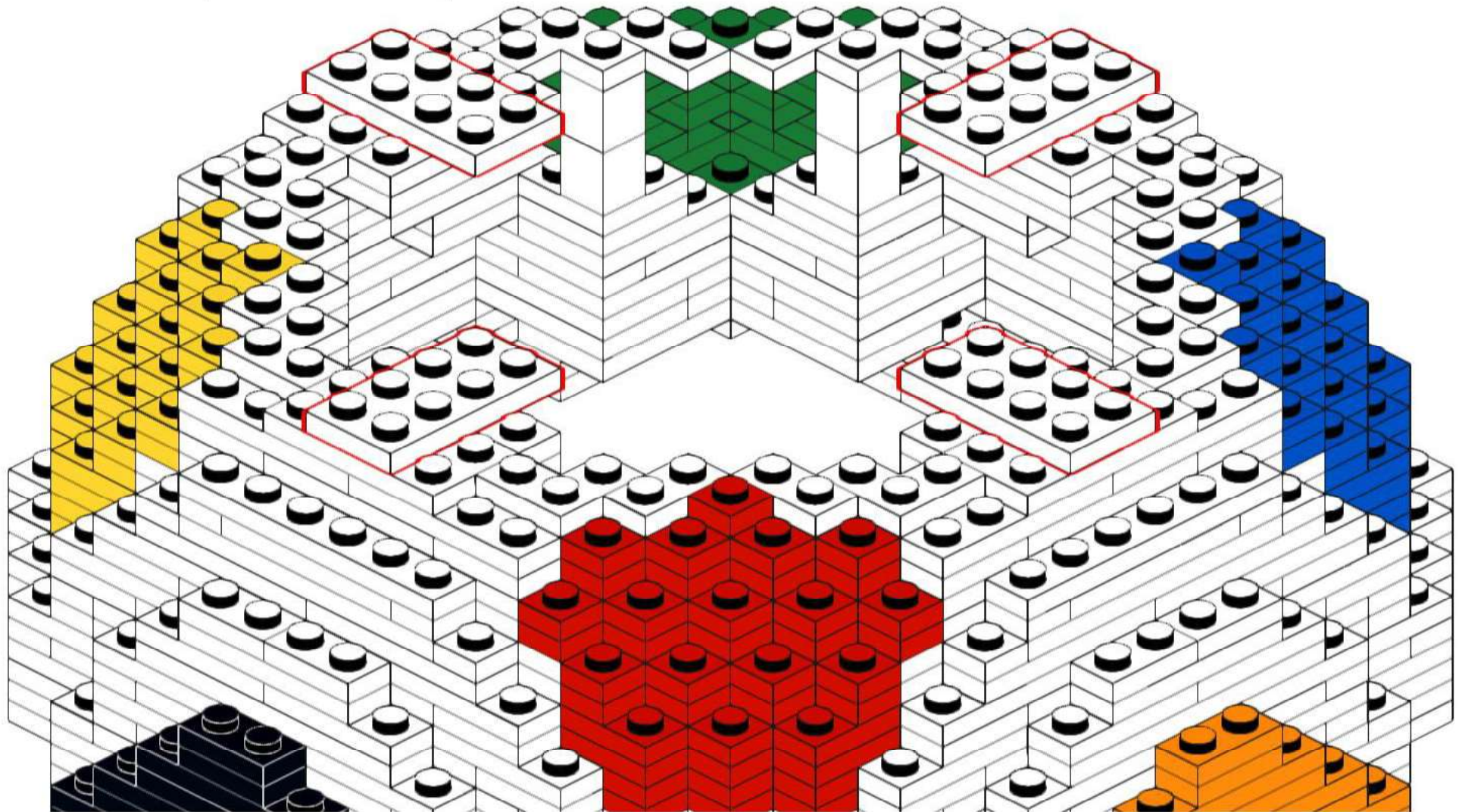
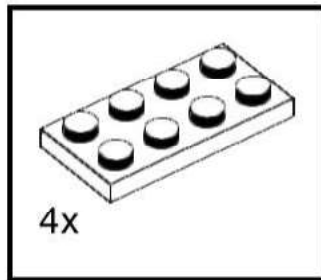

254

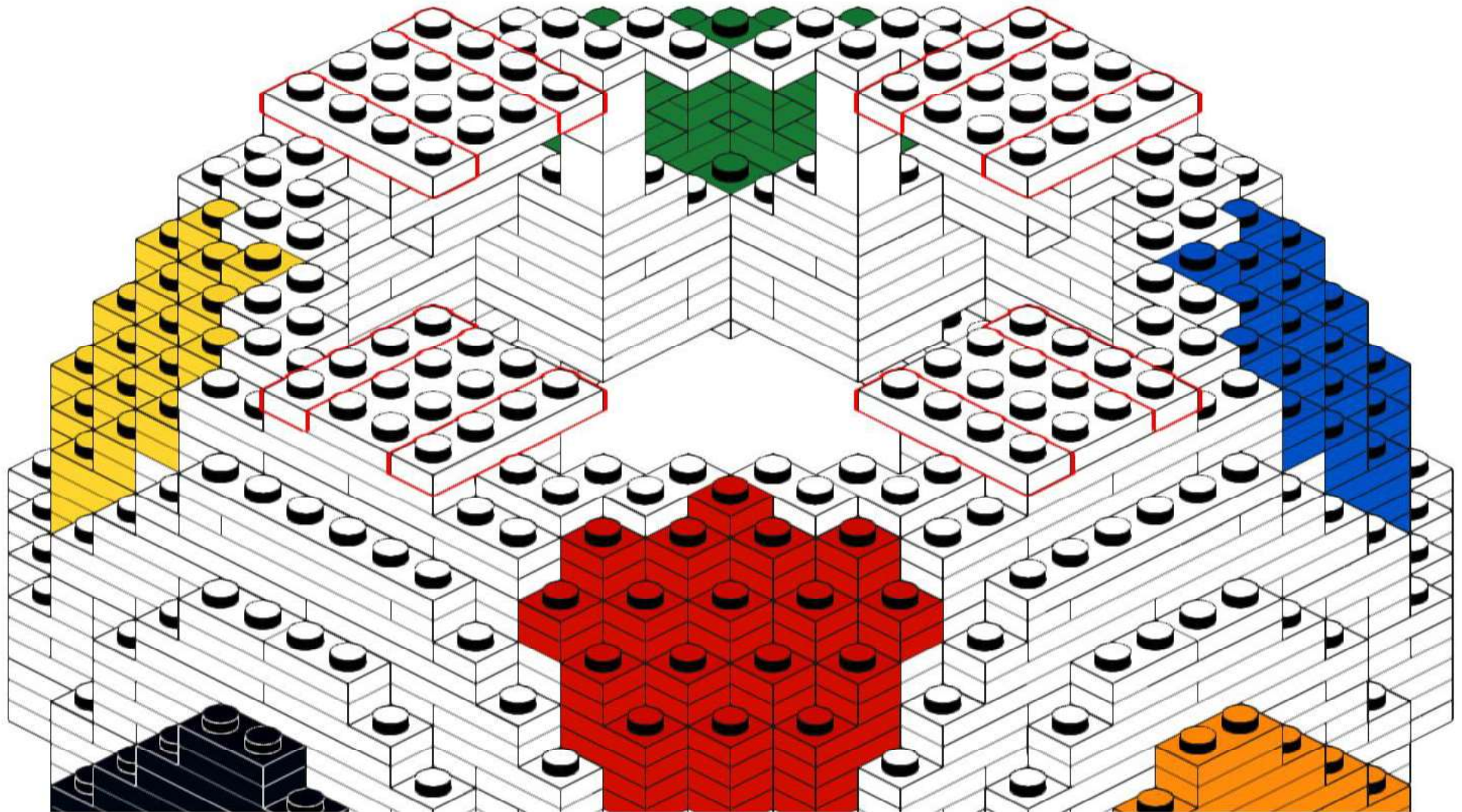
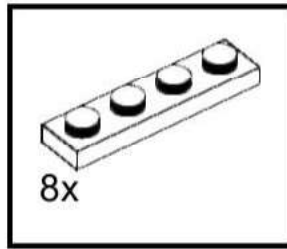

255

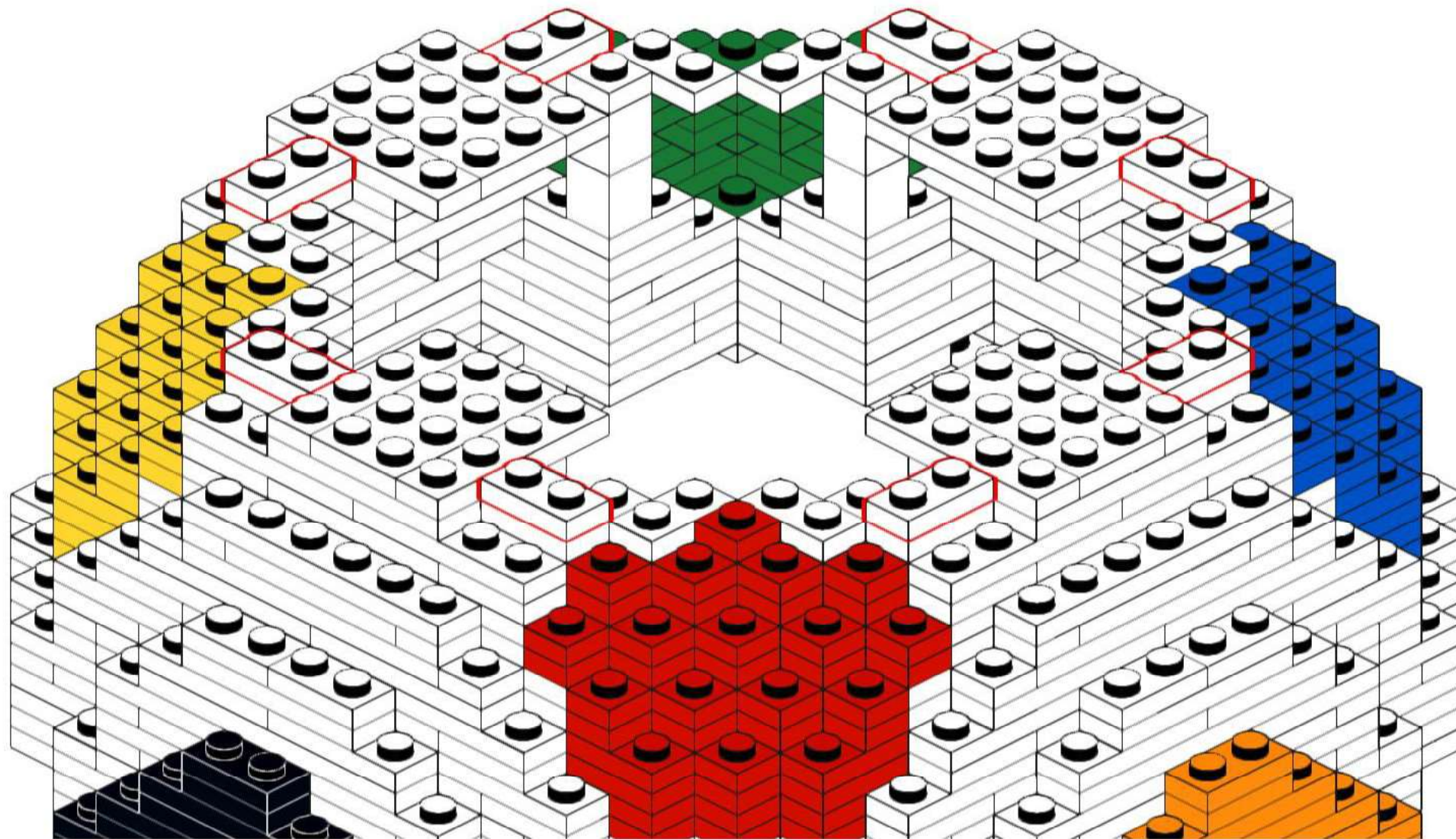
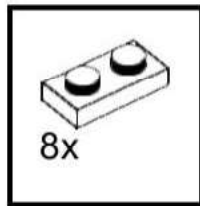

256

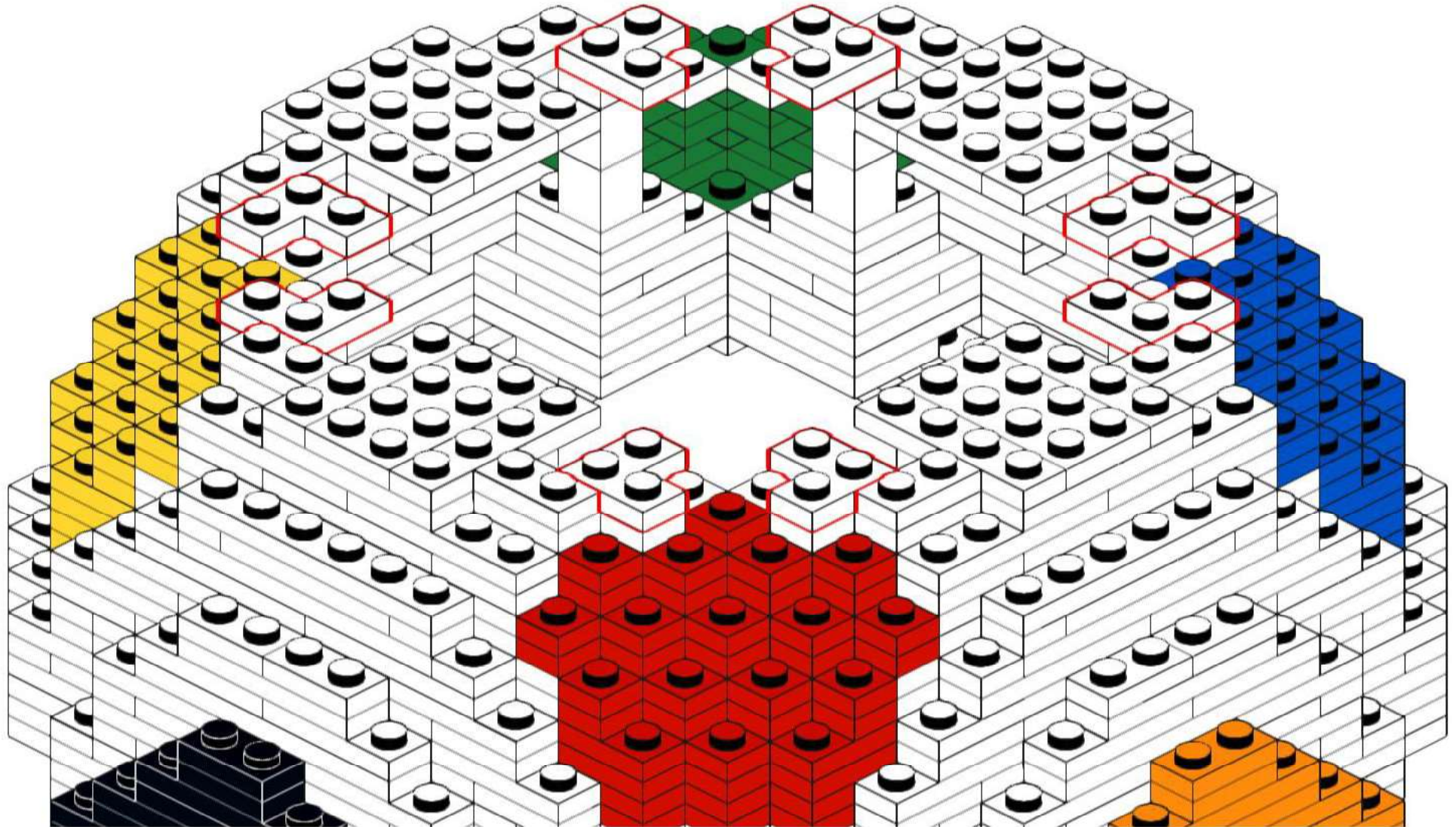
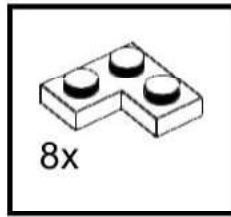

257

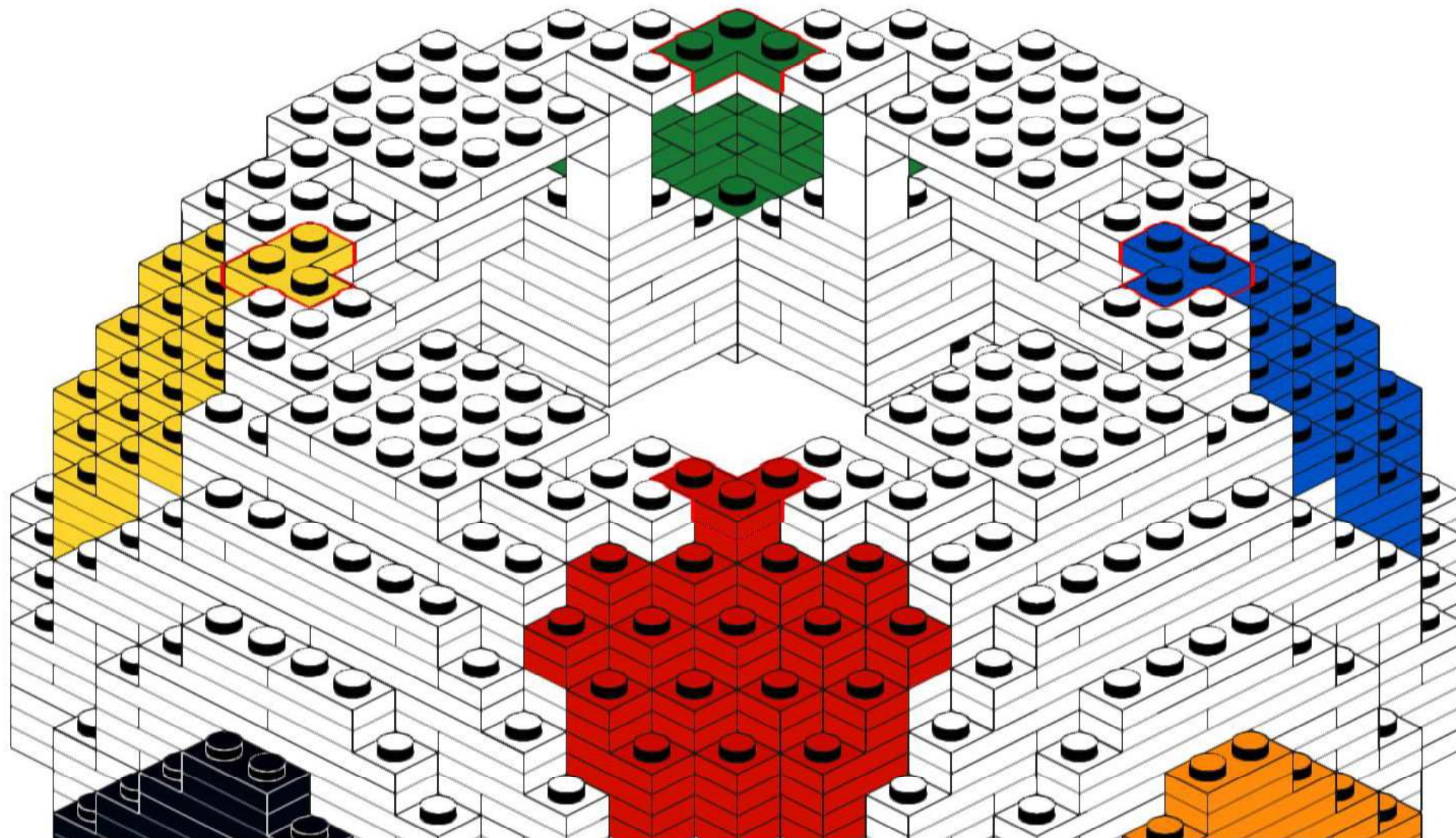
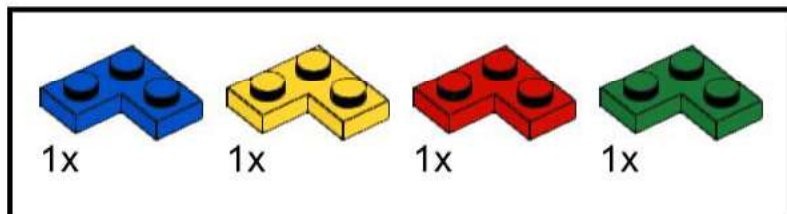

258

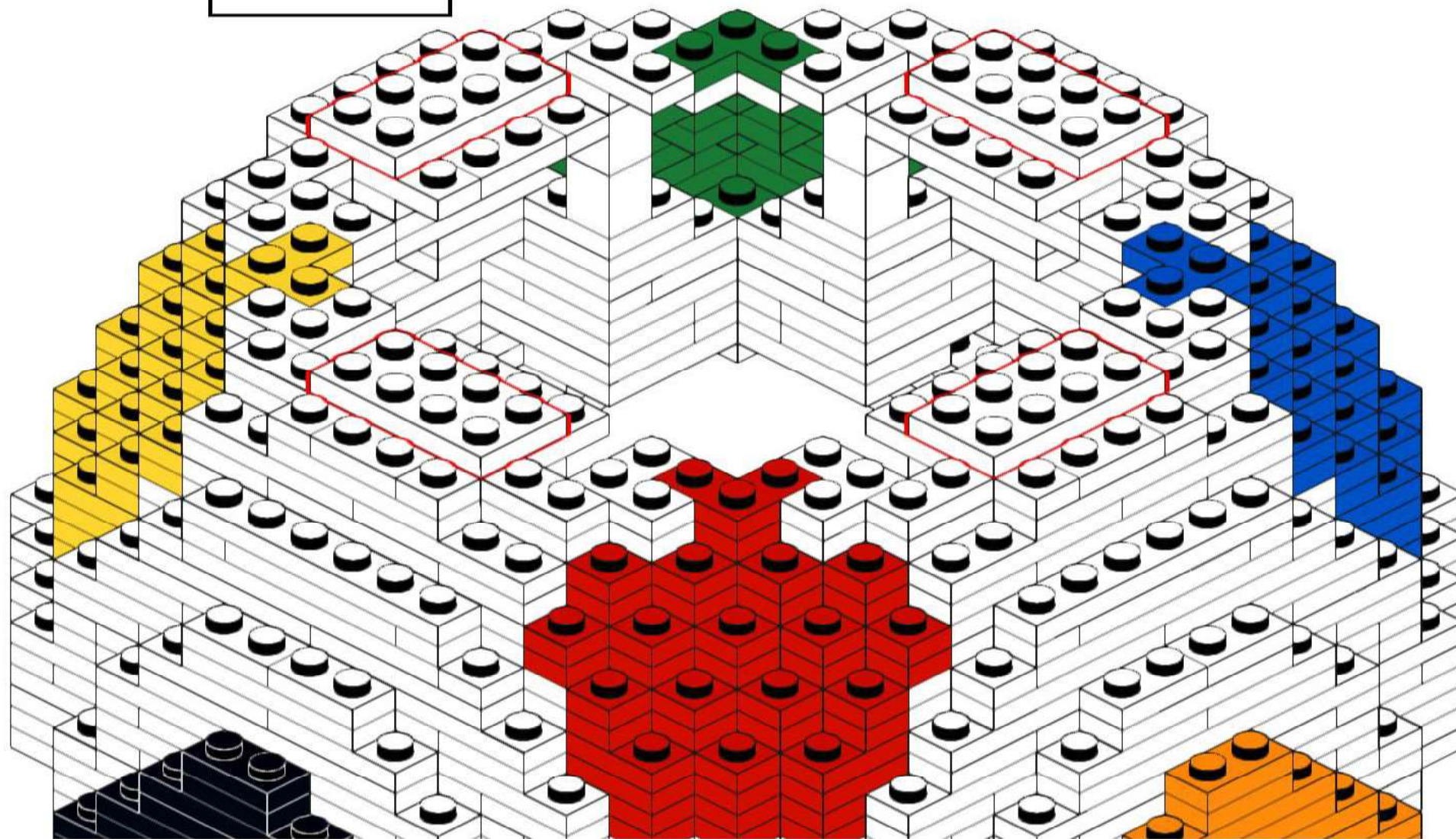
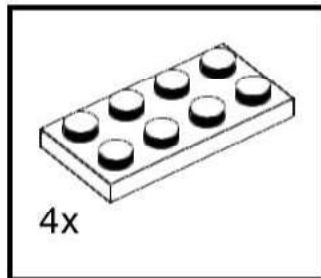

259

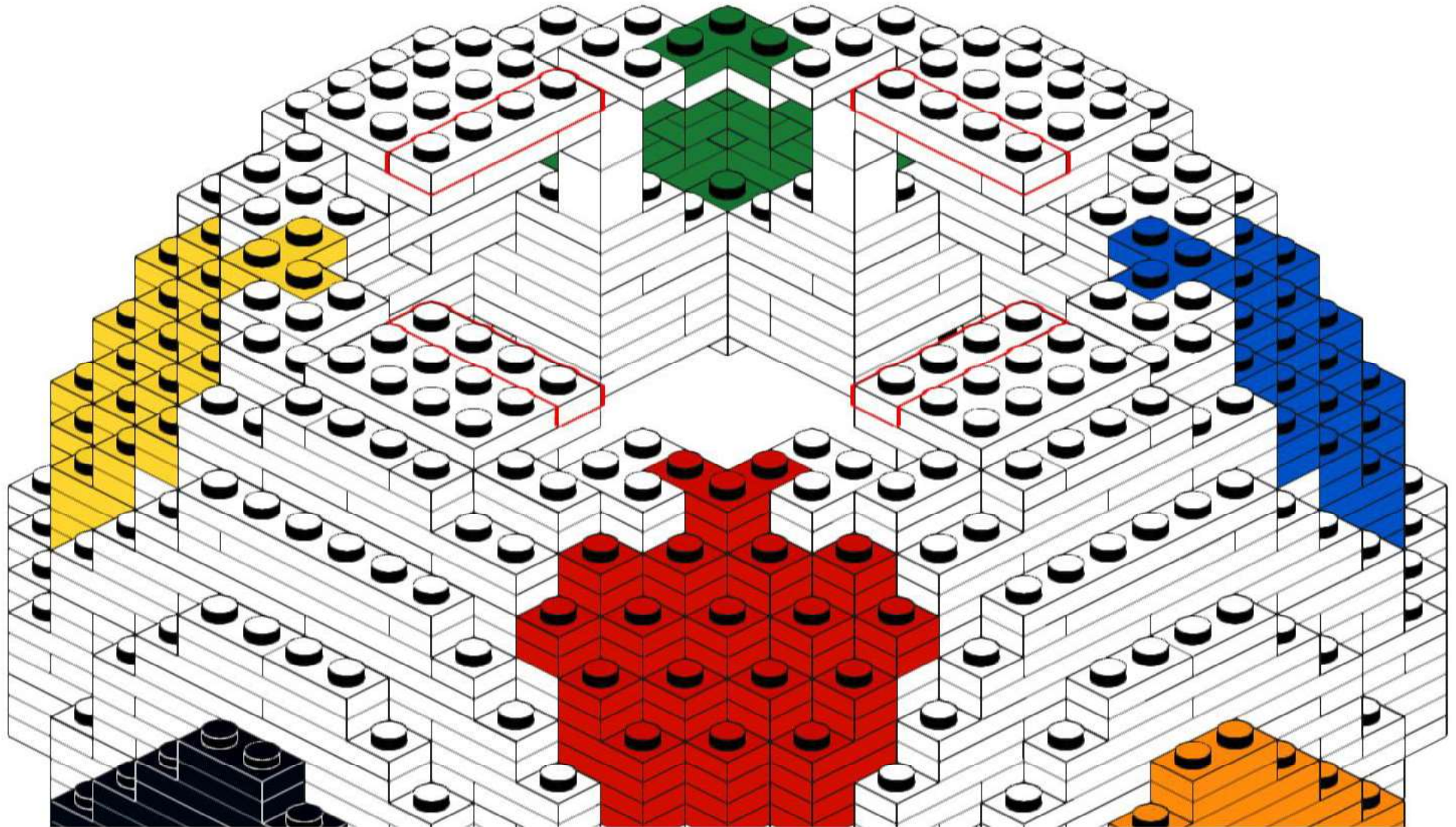
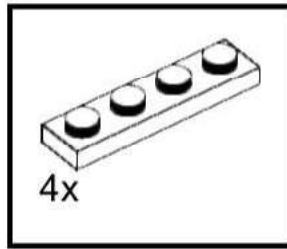

260

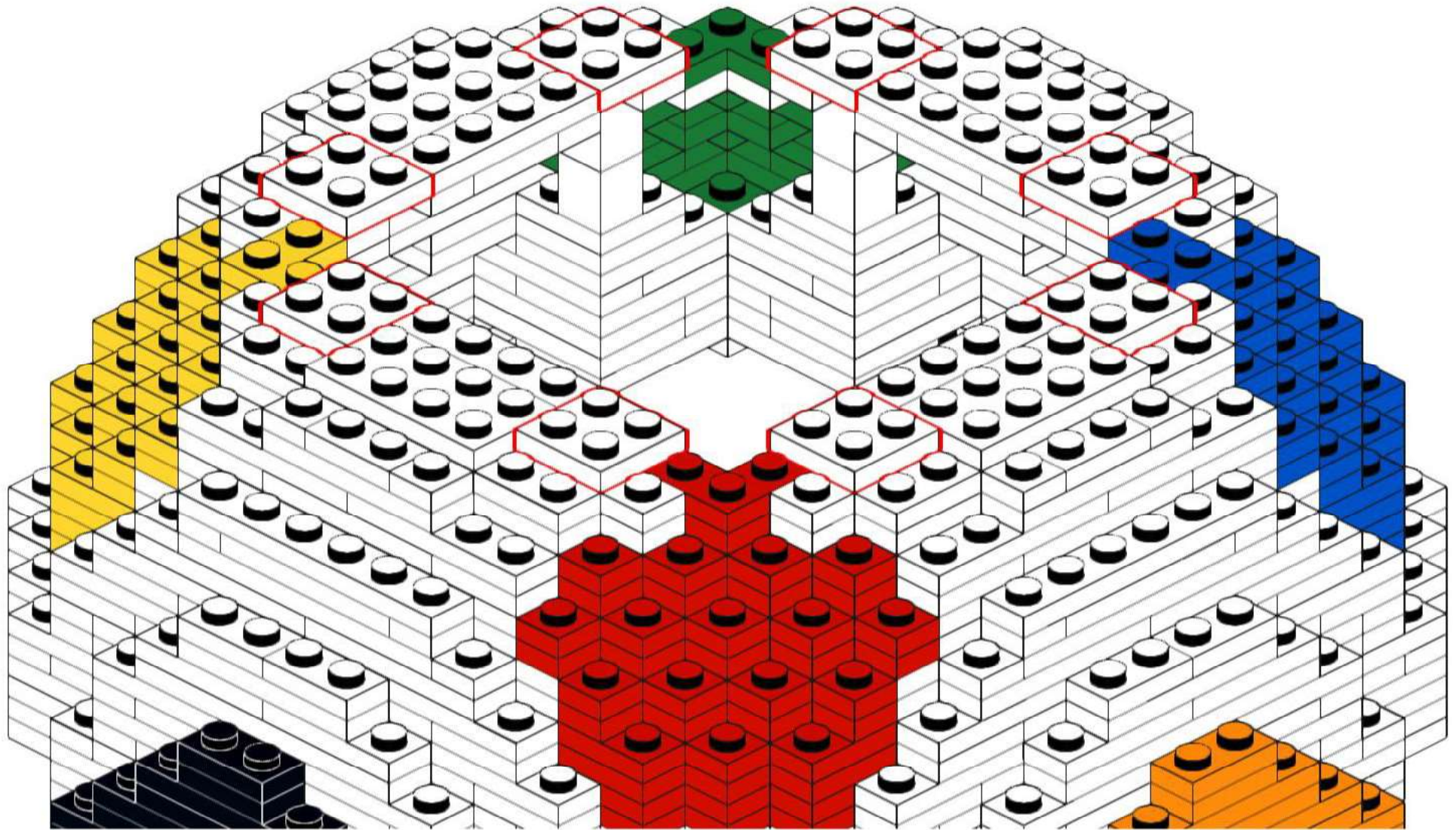
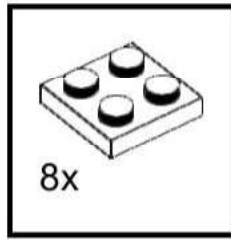

261

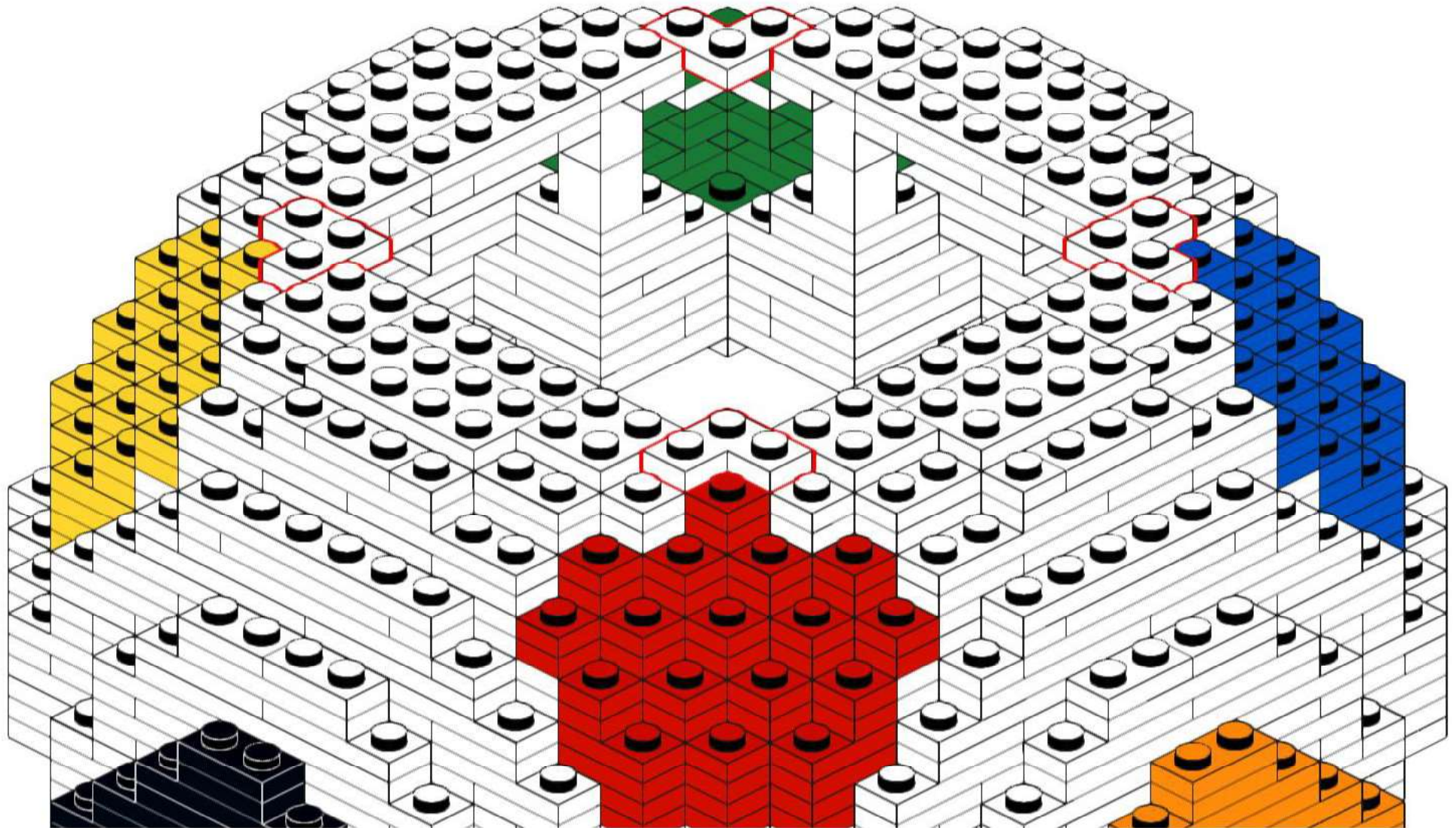
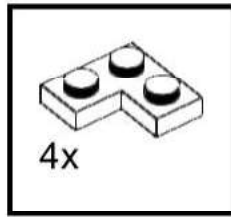

262

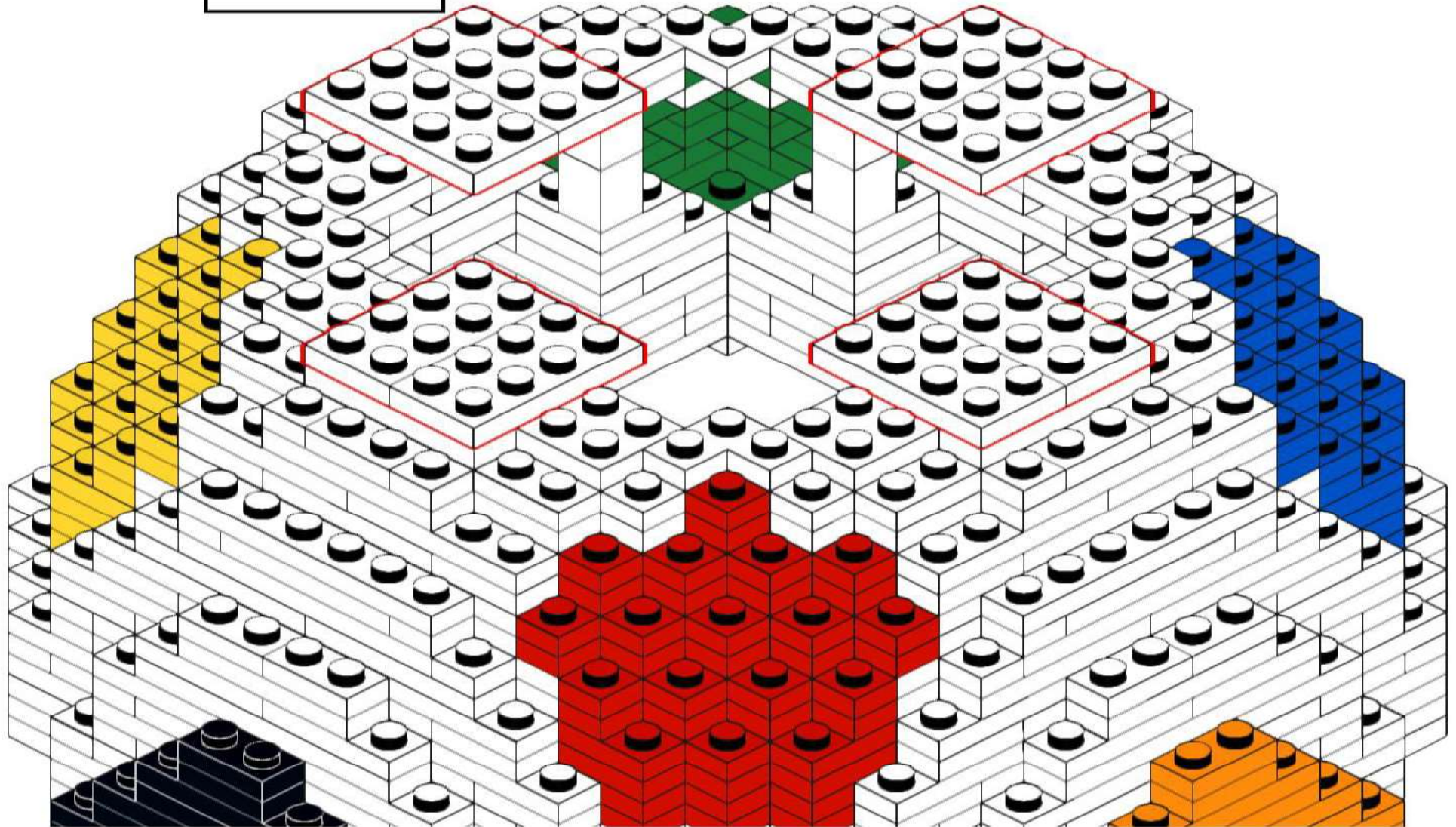
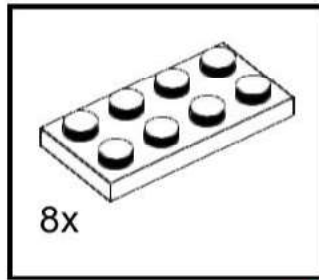

263

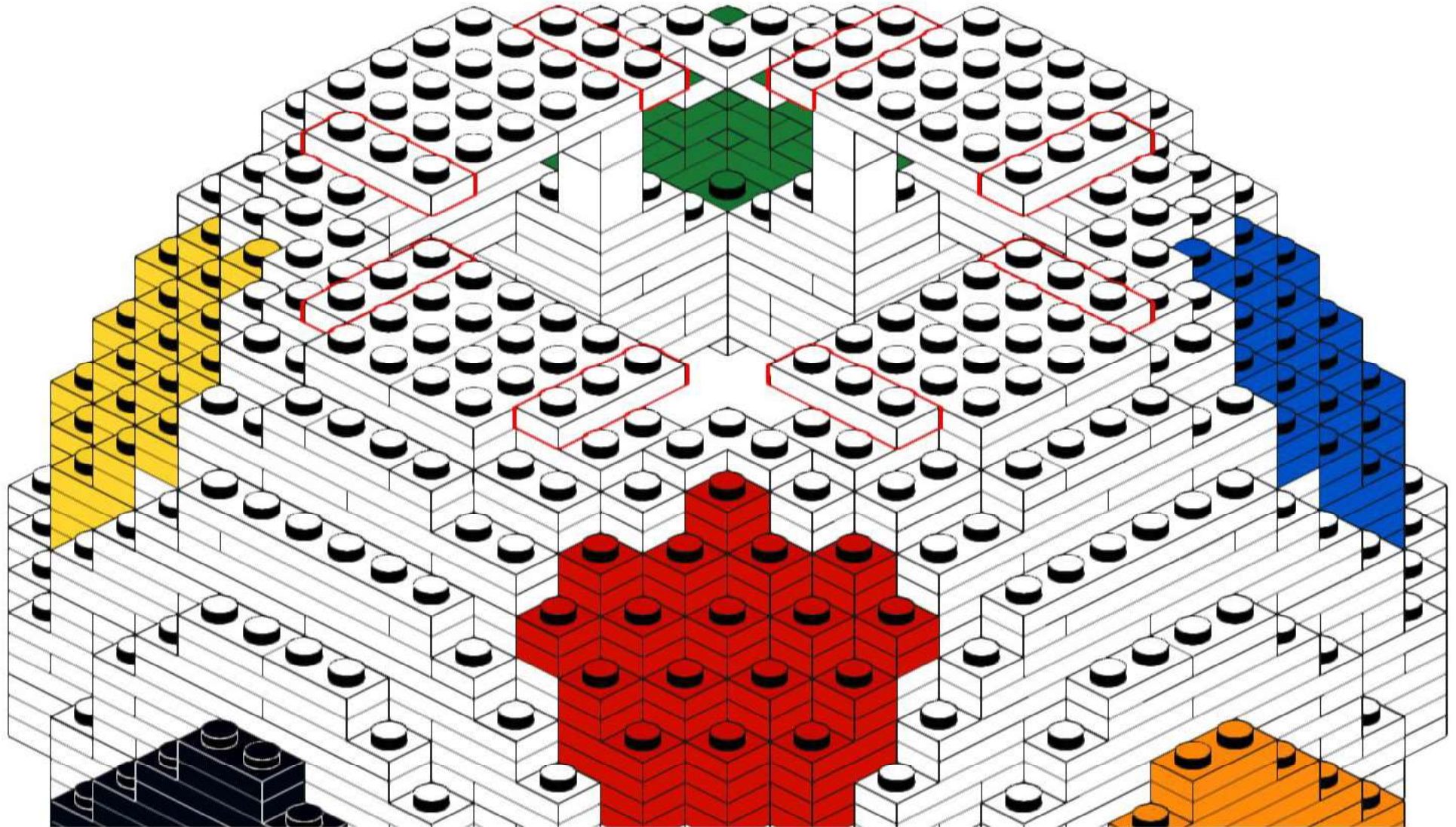
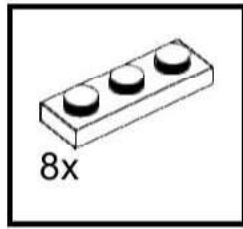

264

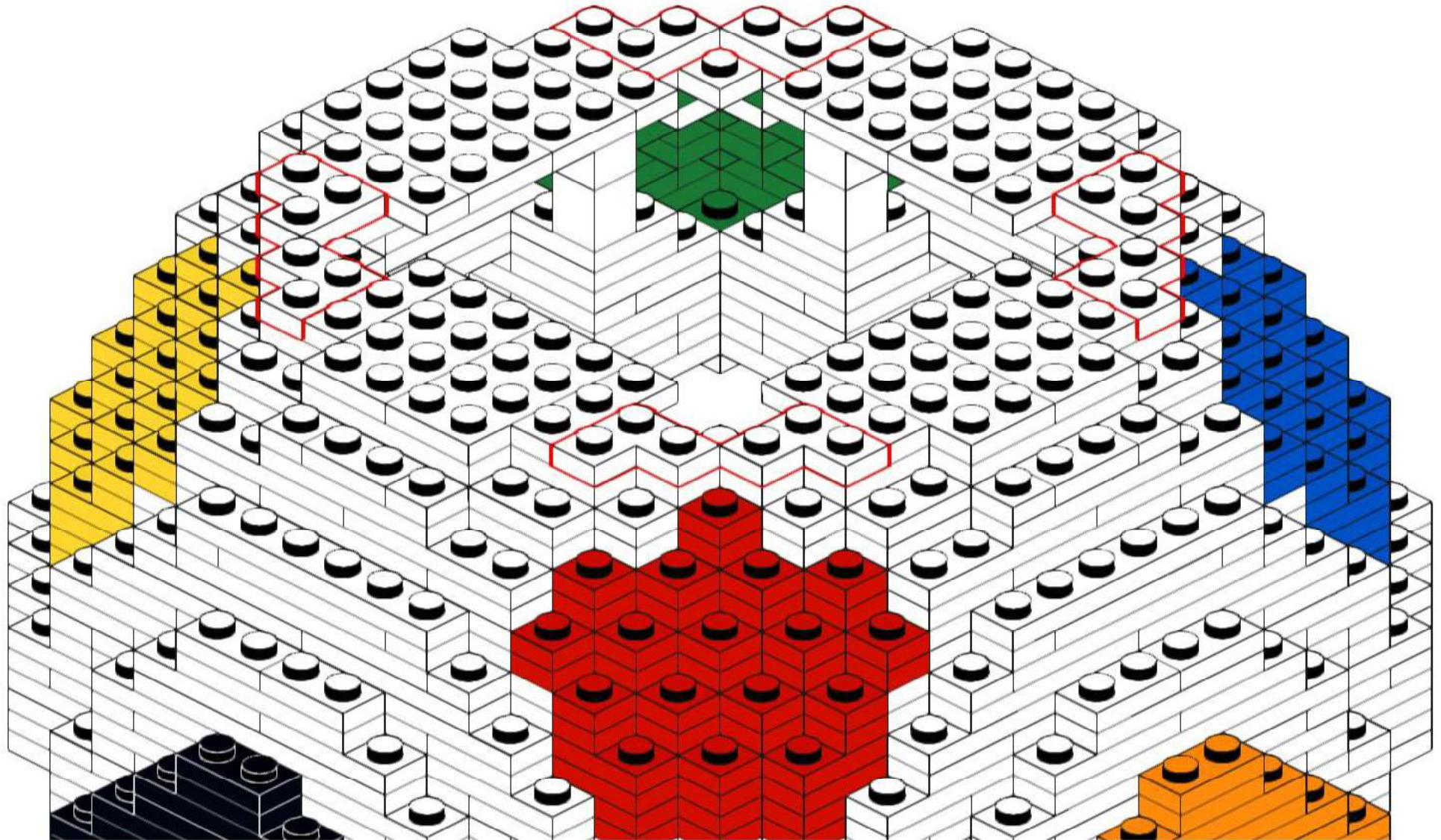
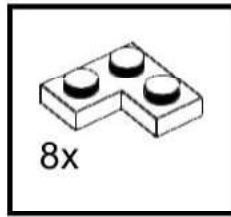

265

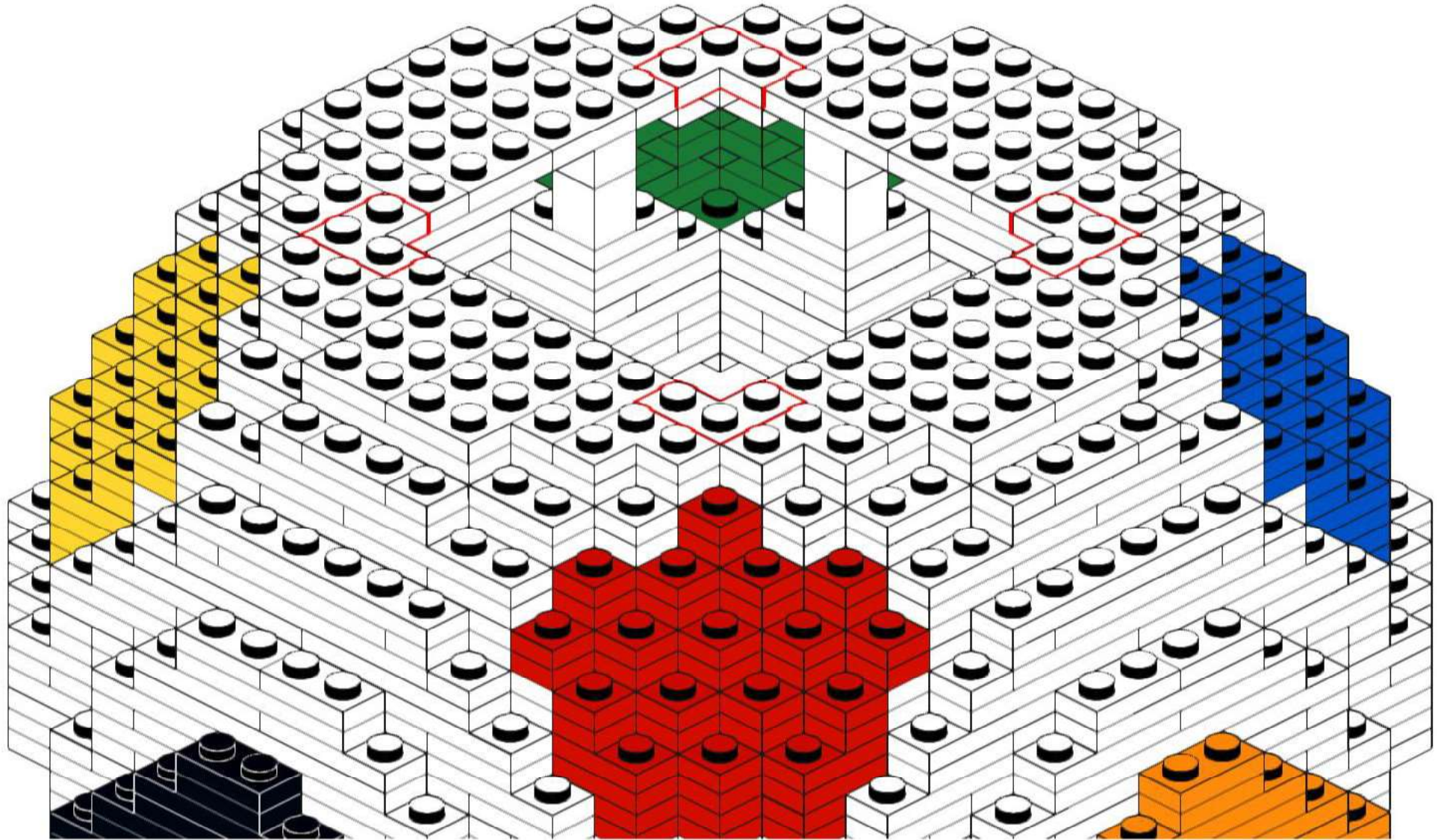
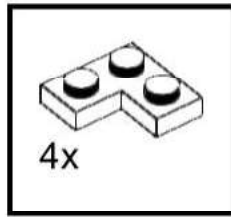

266

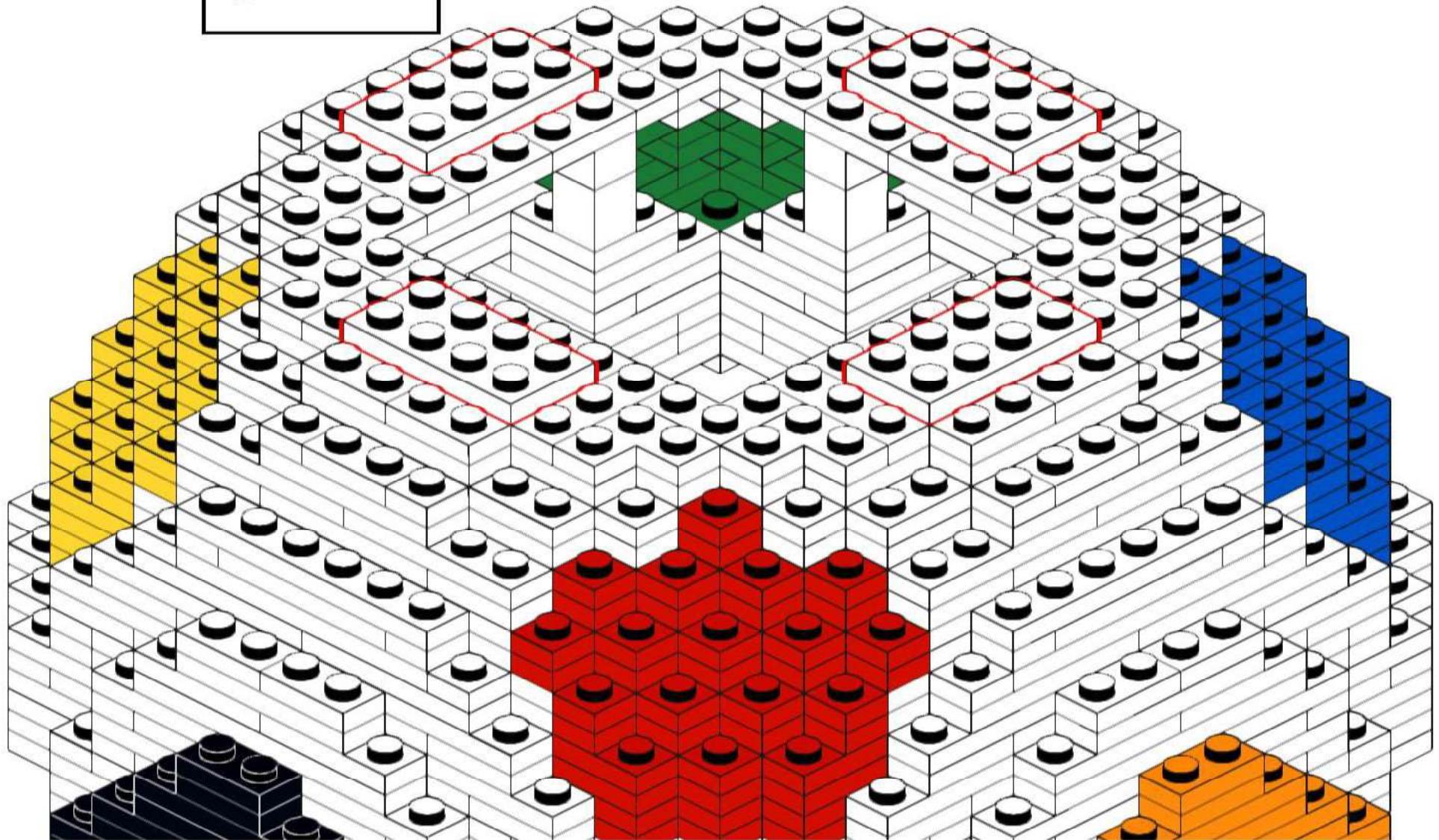
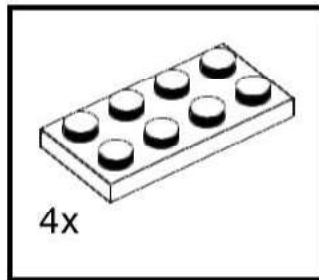

267

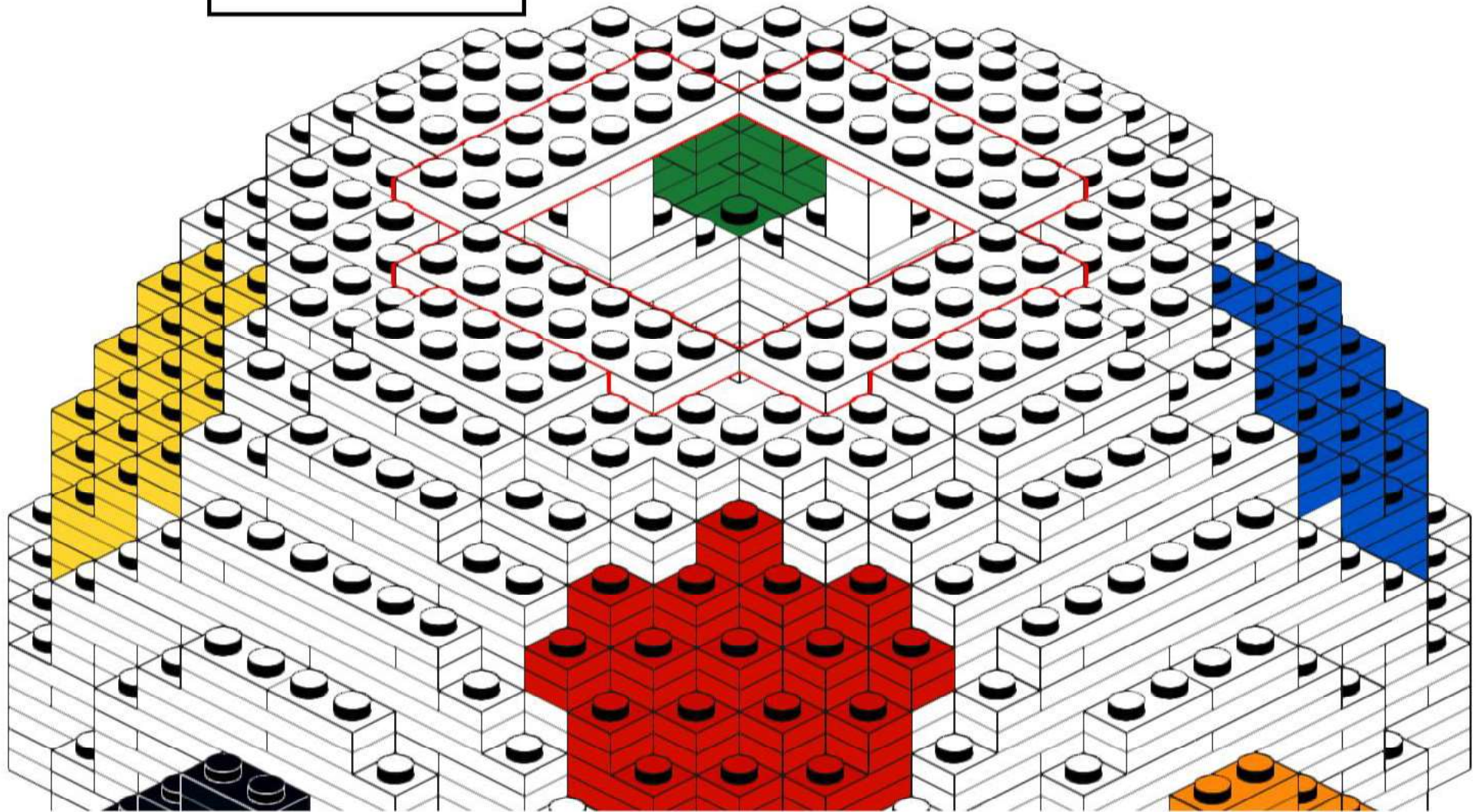
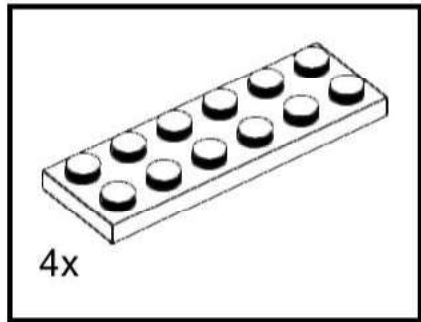

268

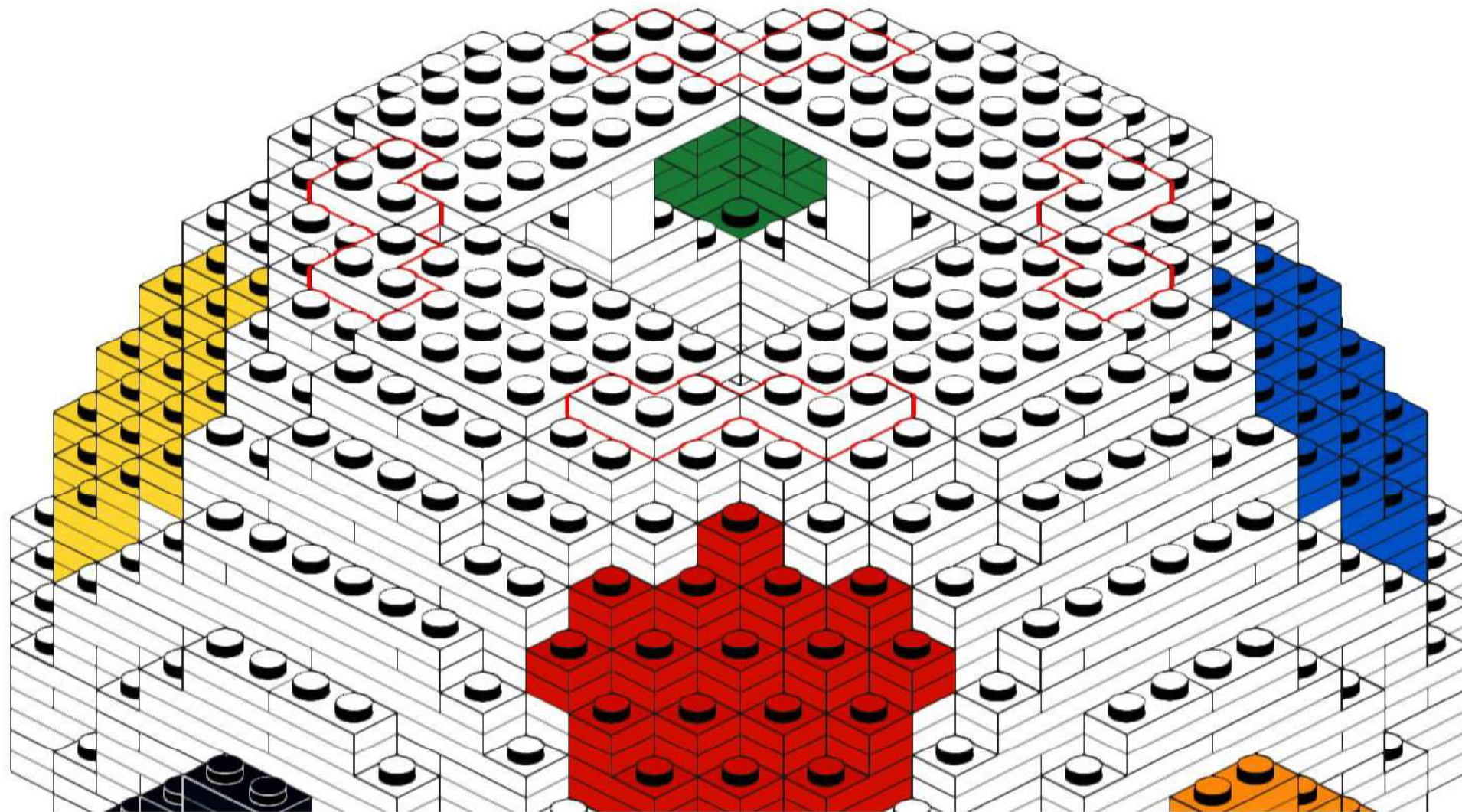
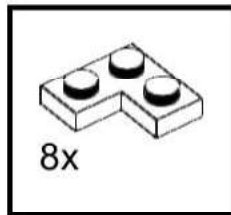

269

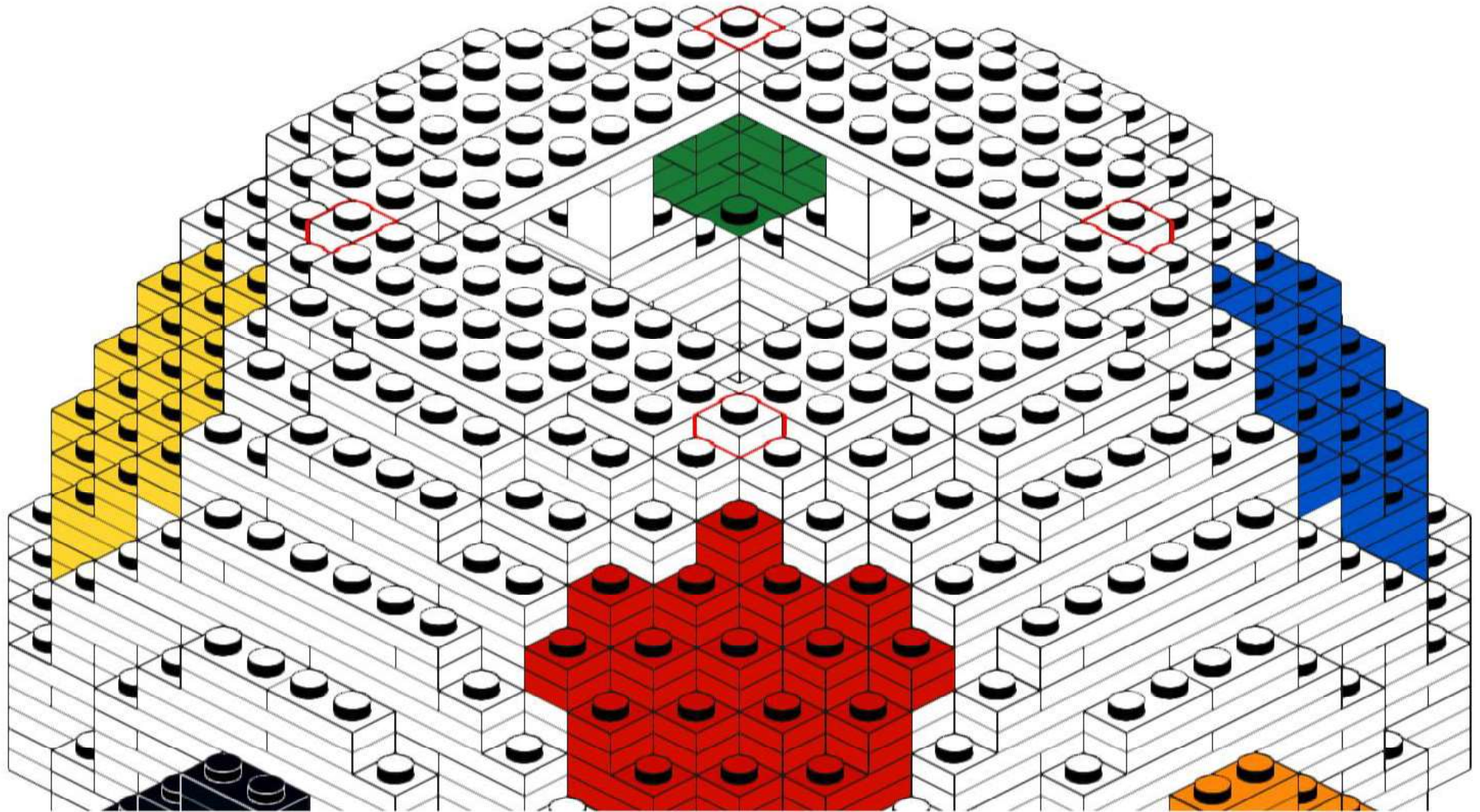
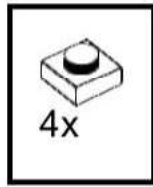

270

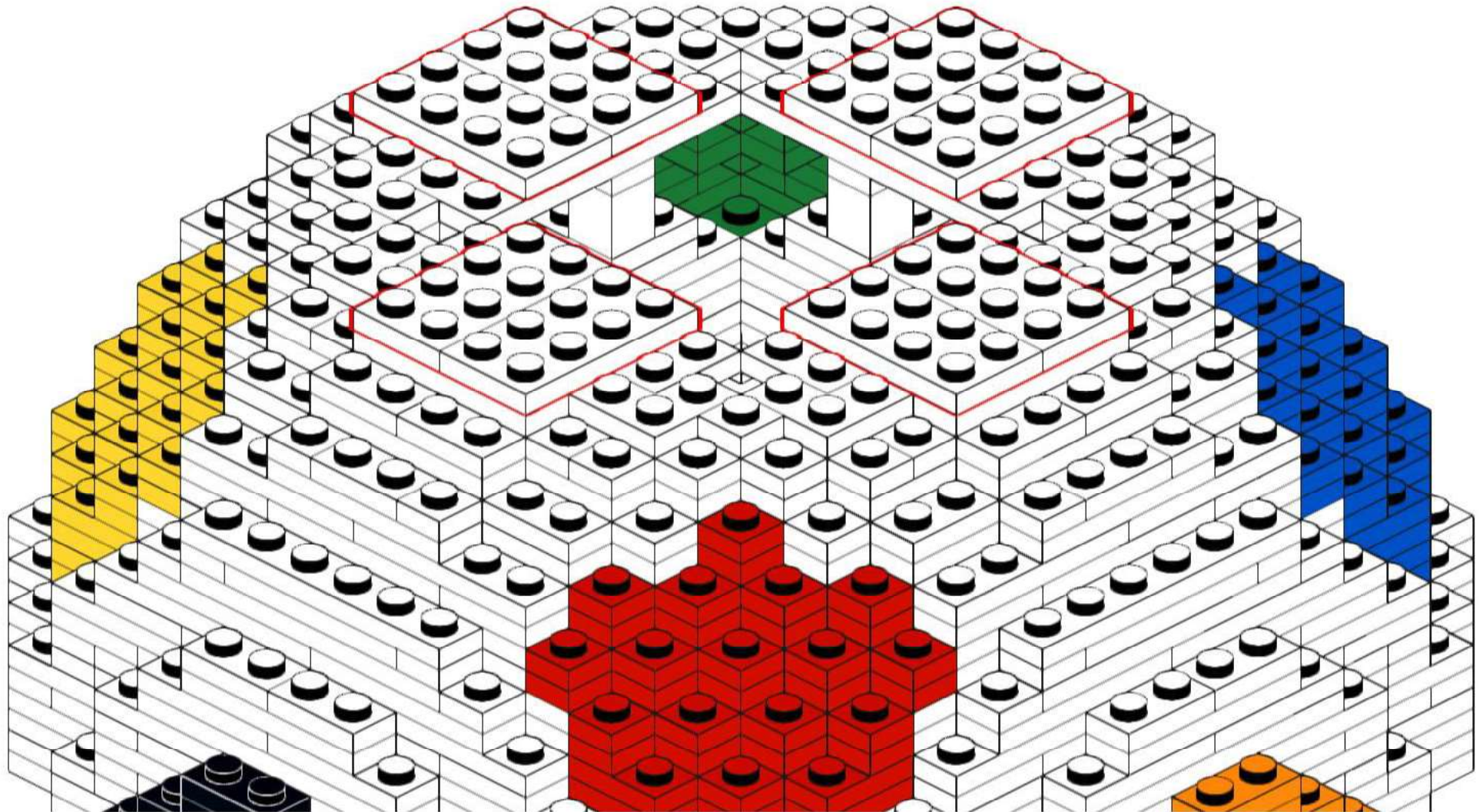
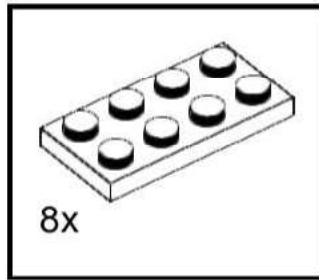

271

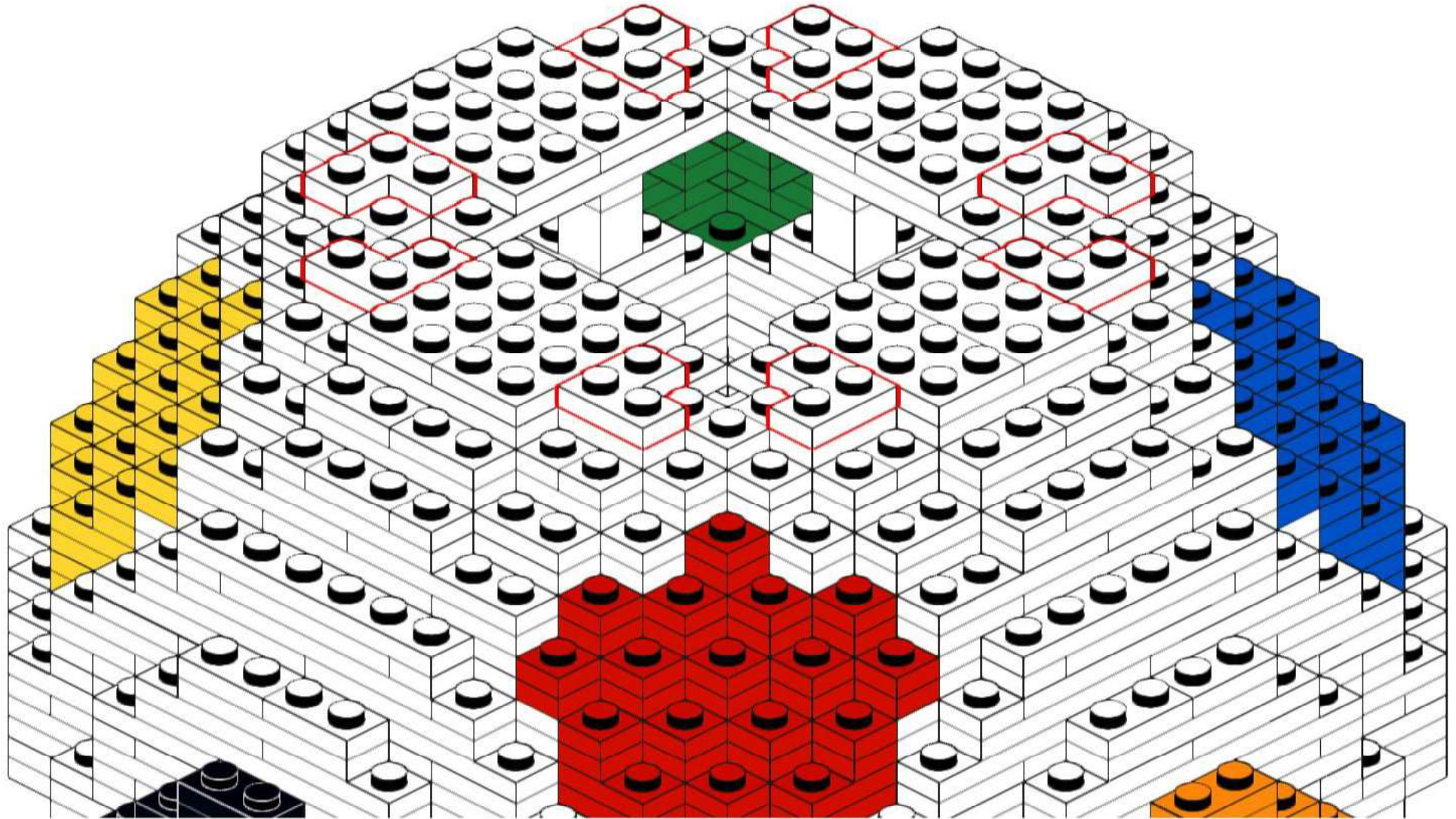
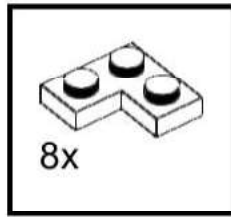

272

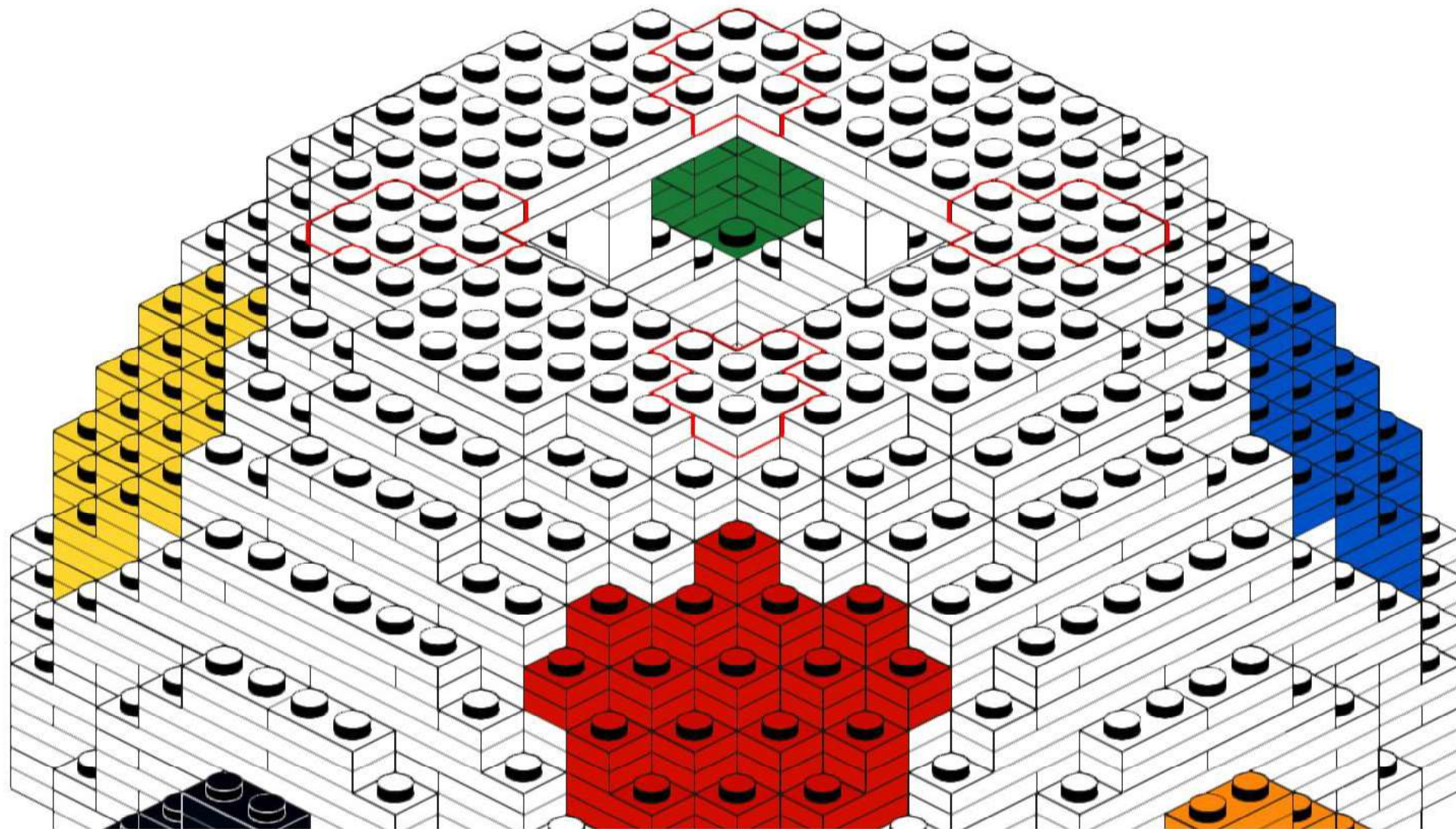
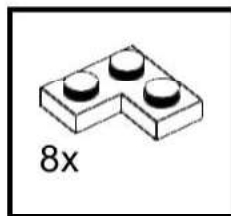

273

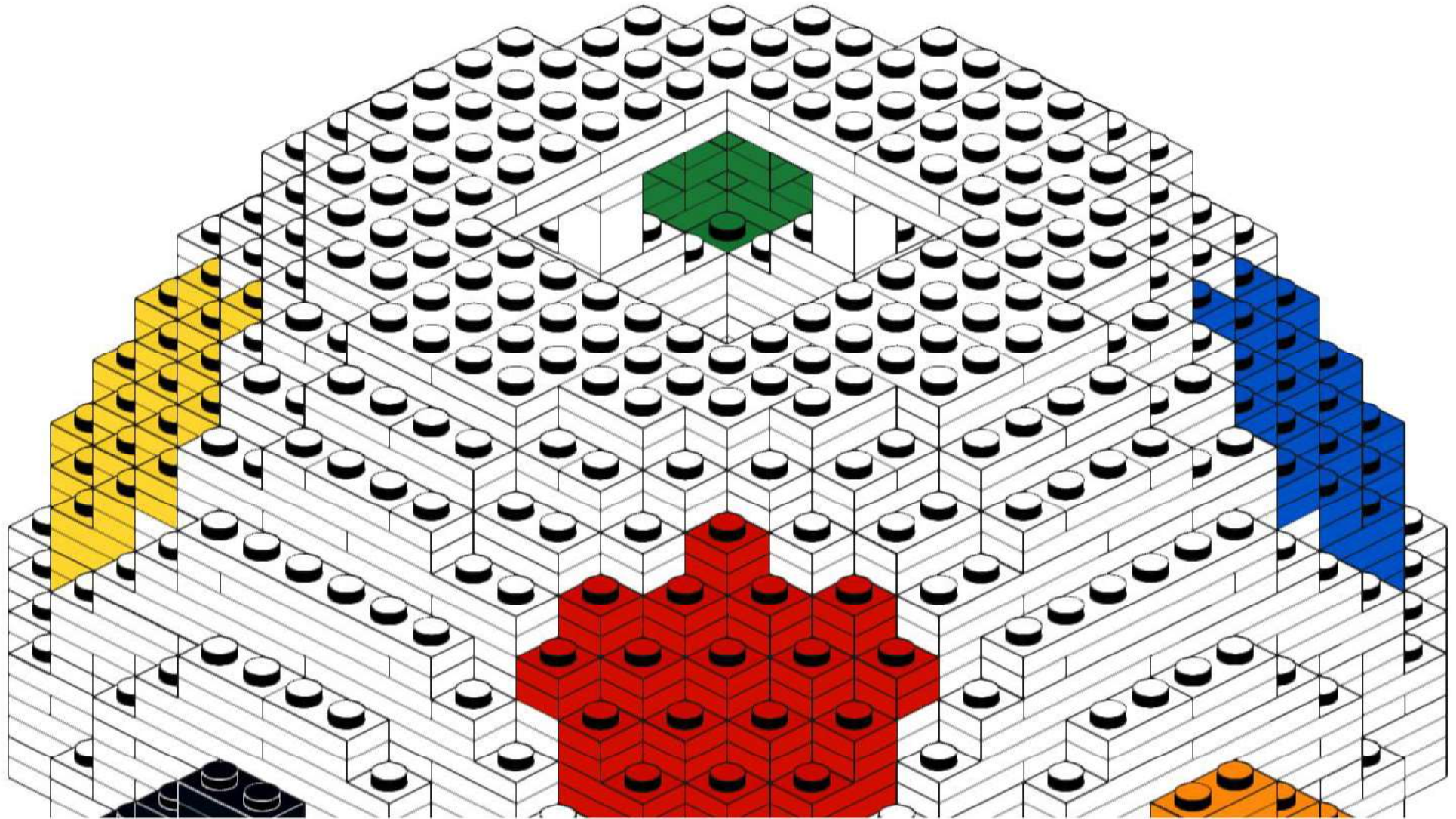

274

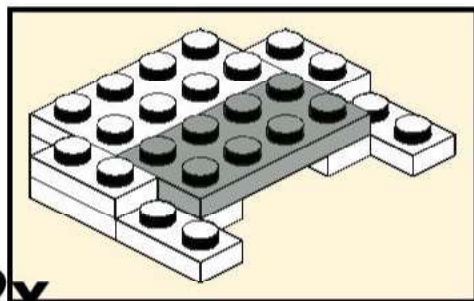

2x

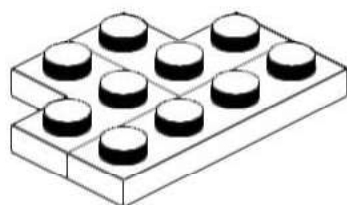
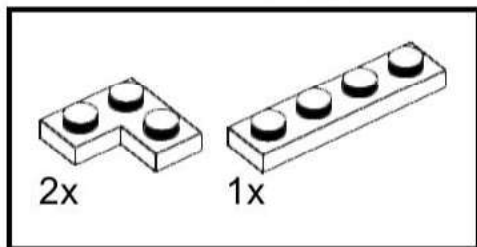

275

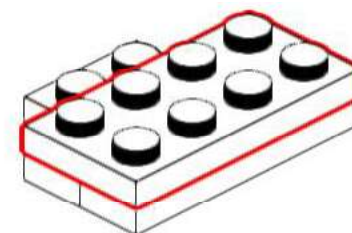
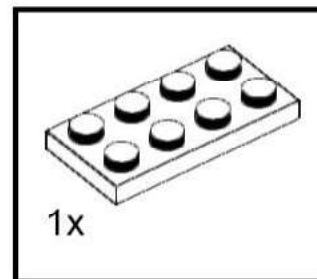

276

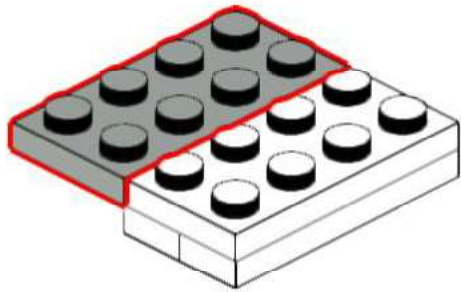
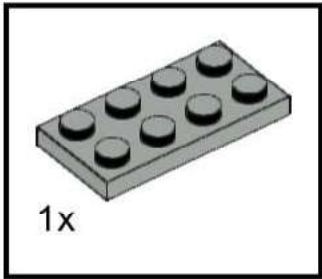

277

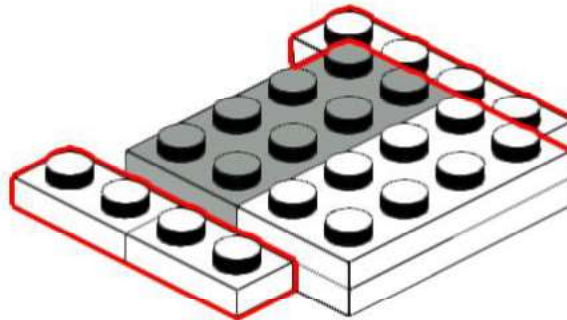
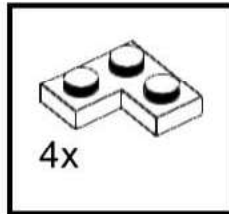

278

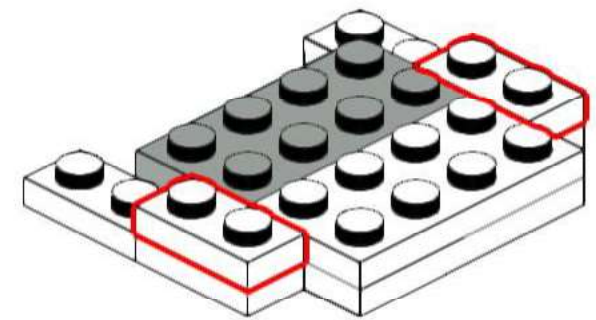
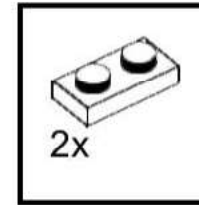

279

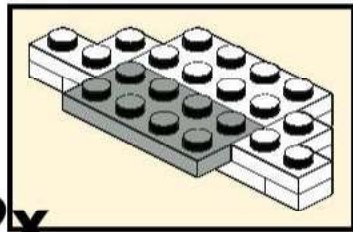

2x

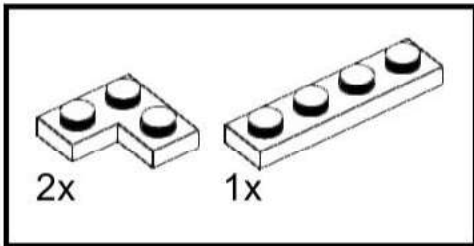

280

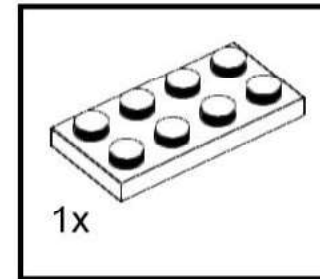

1x

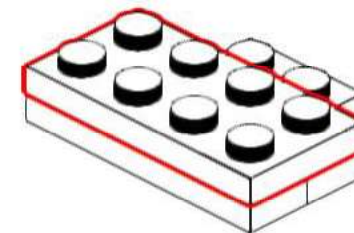
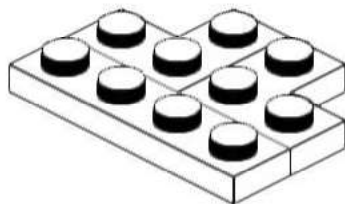

281

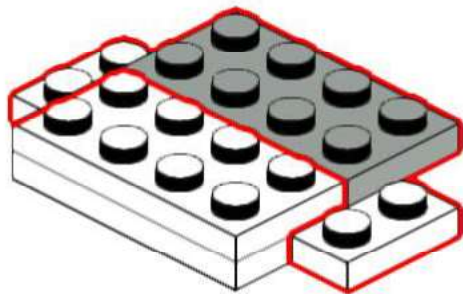
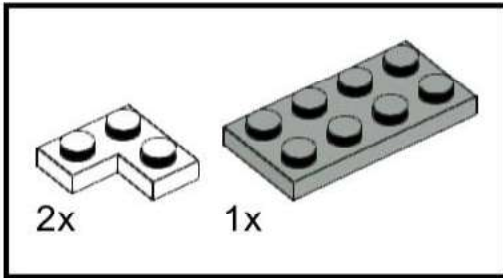

282

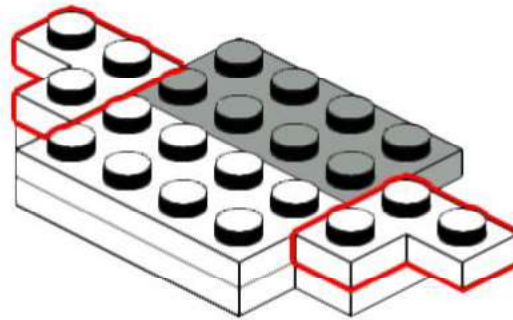
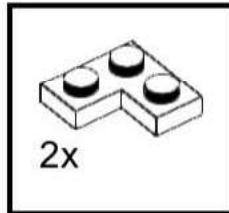

283

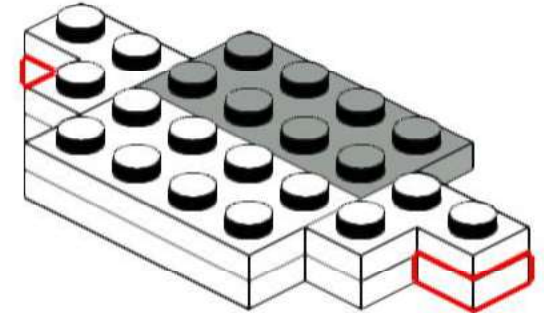
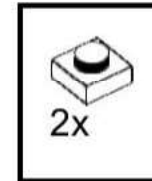

284

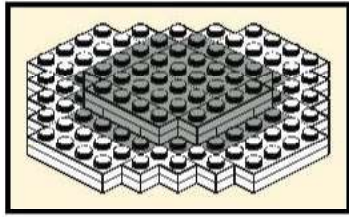

285

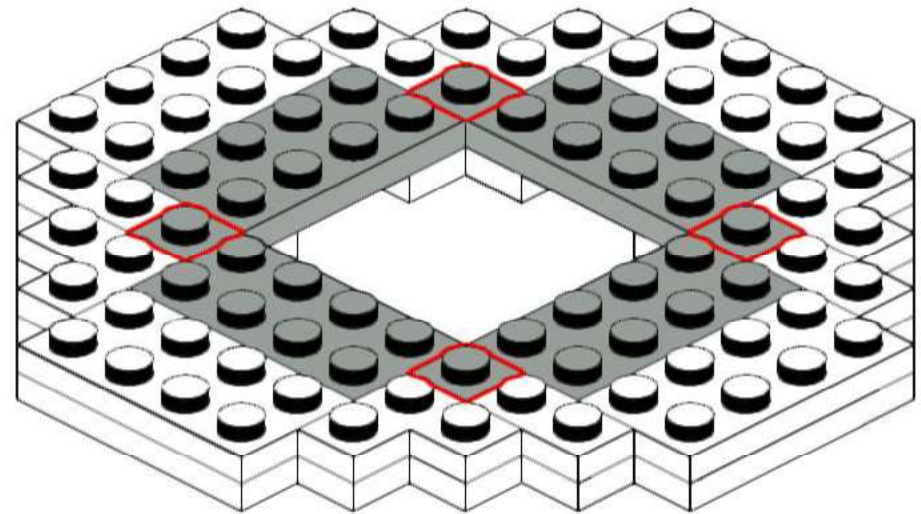
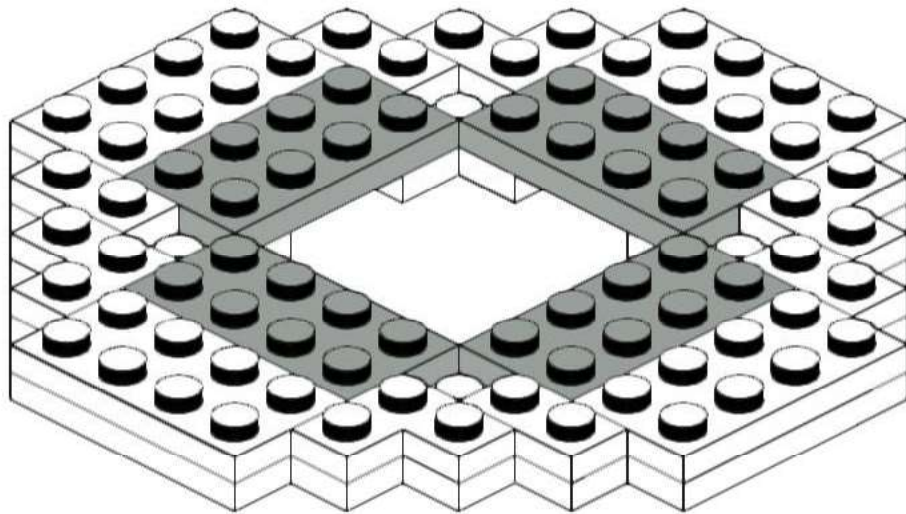
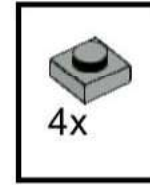

286

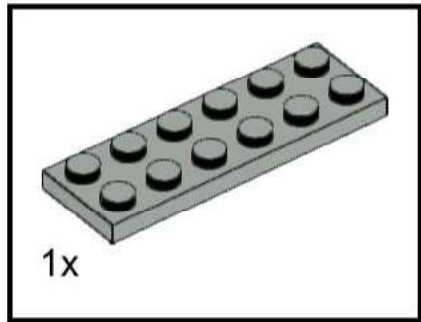

287

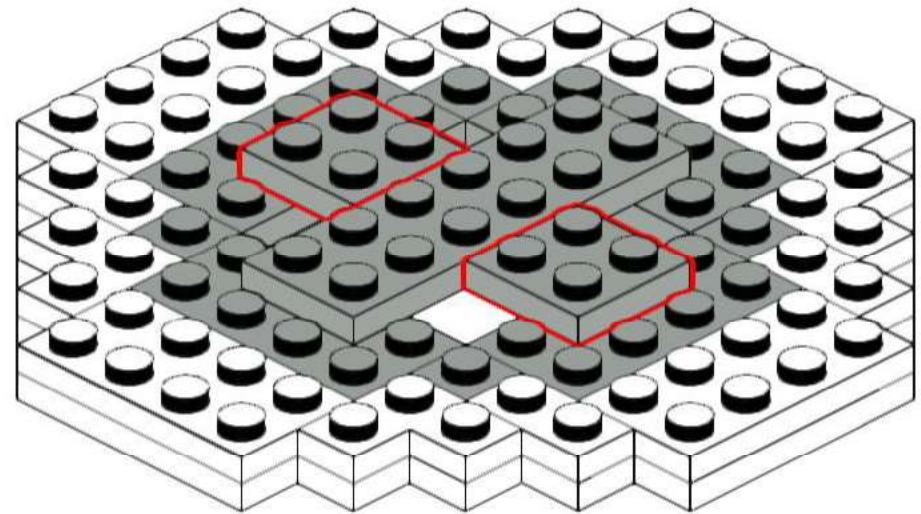
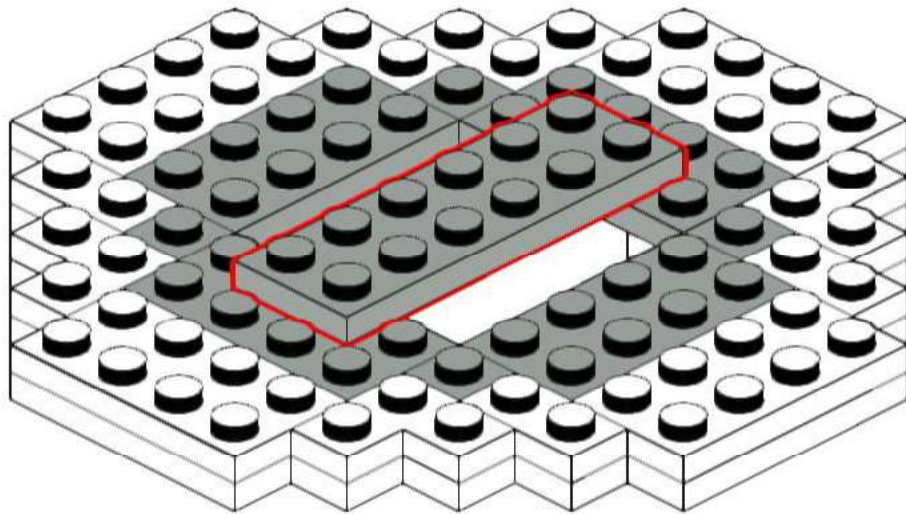
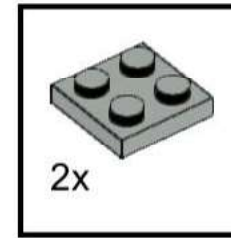

288

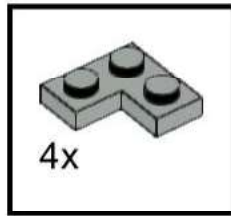

289

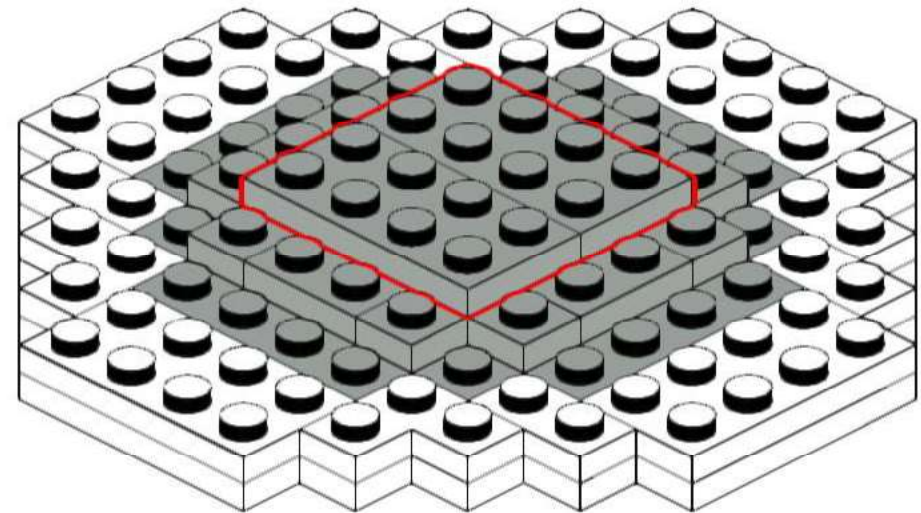
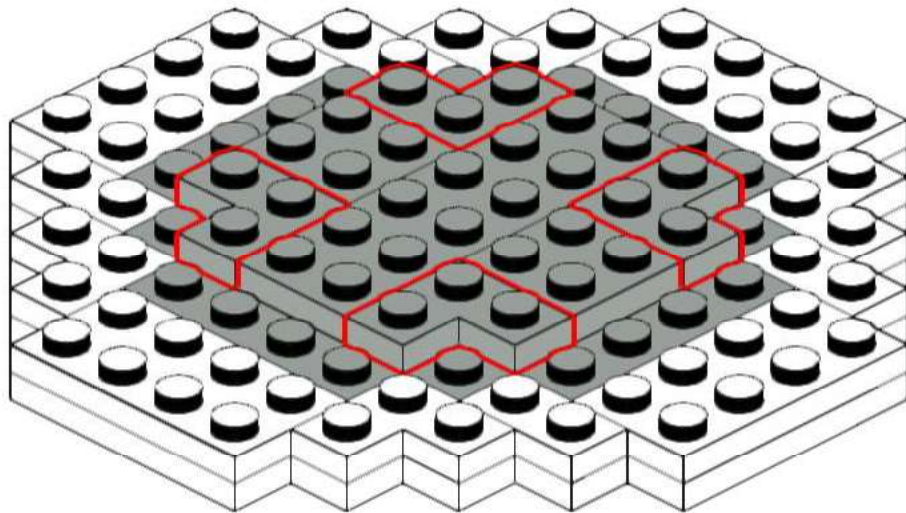
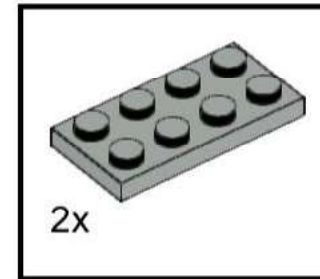

290

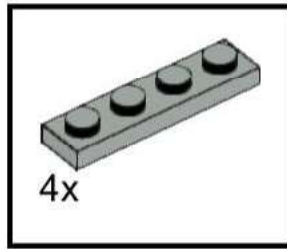

291

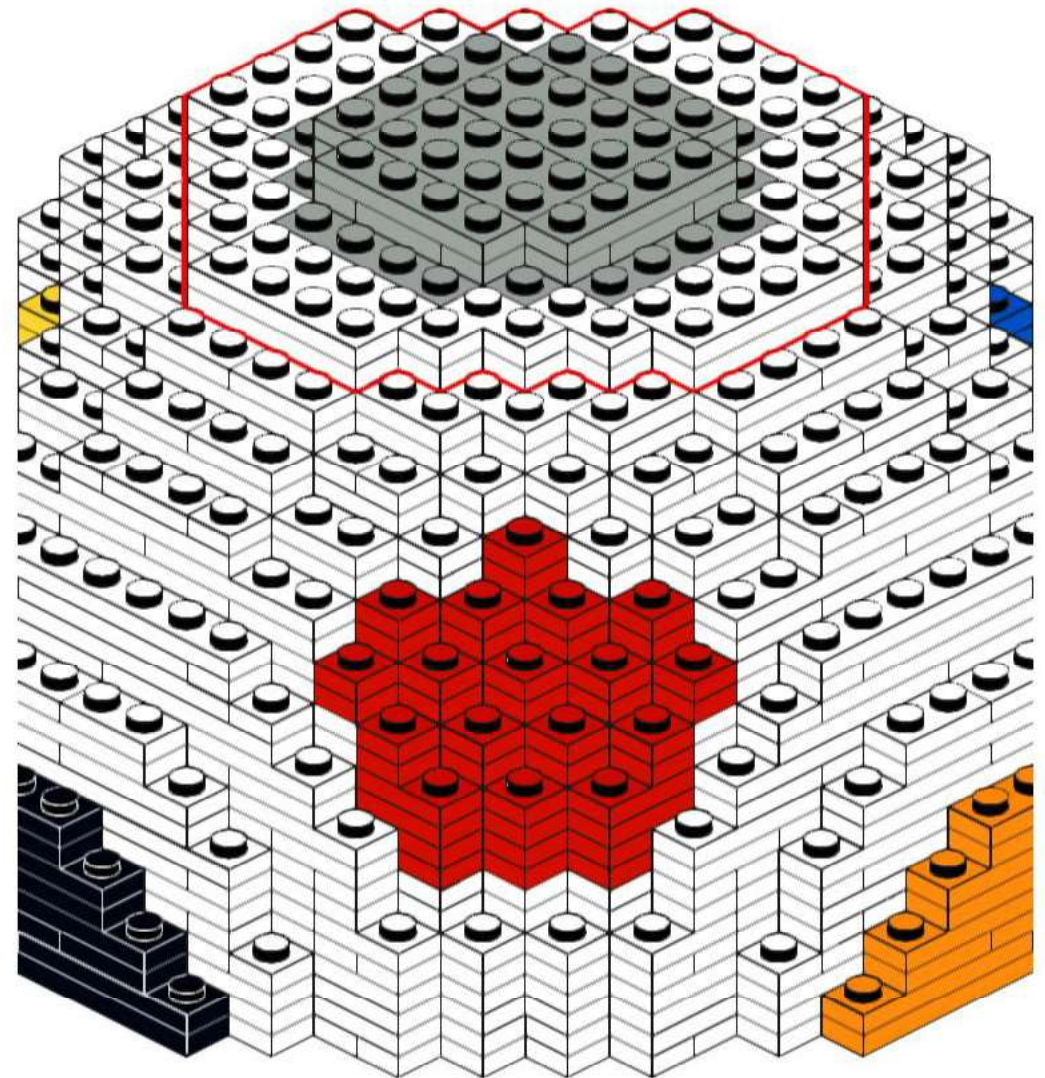
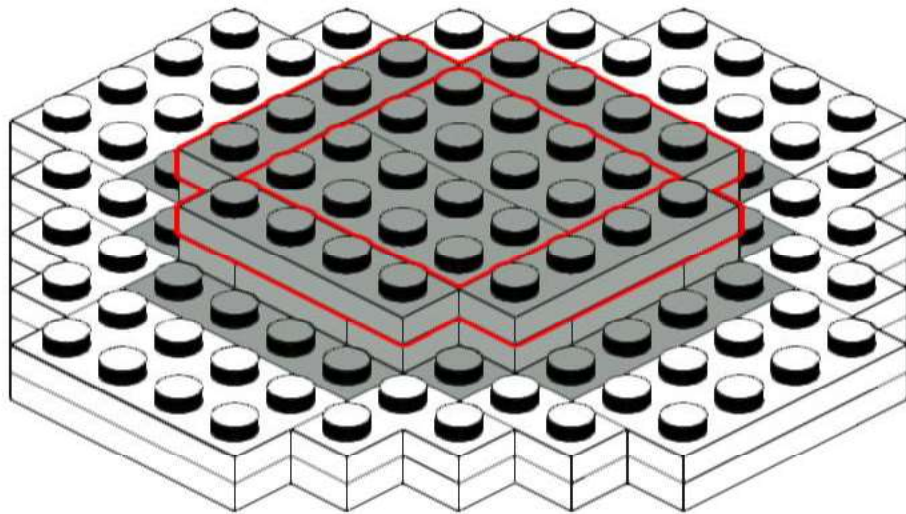

292

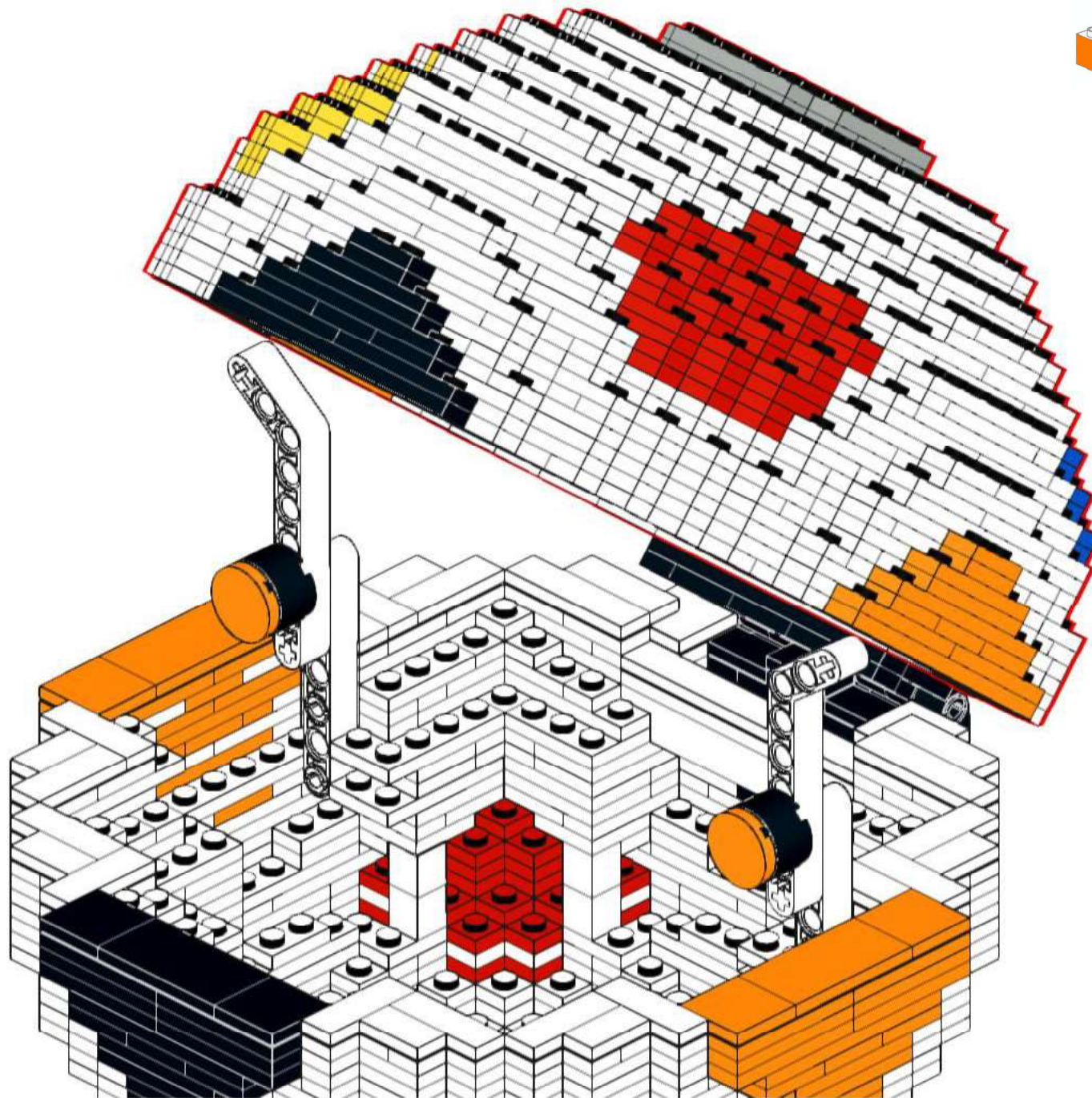

293

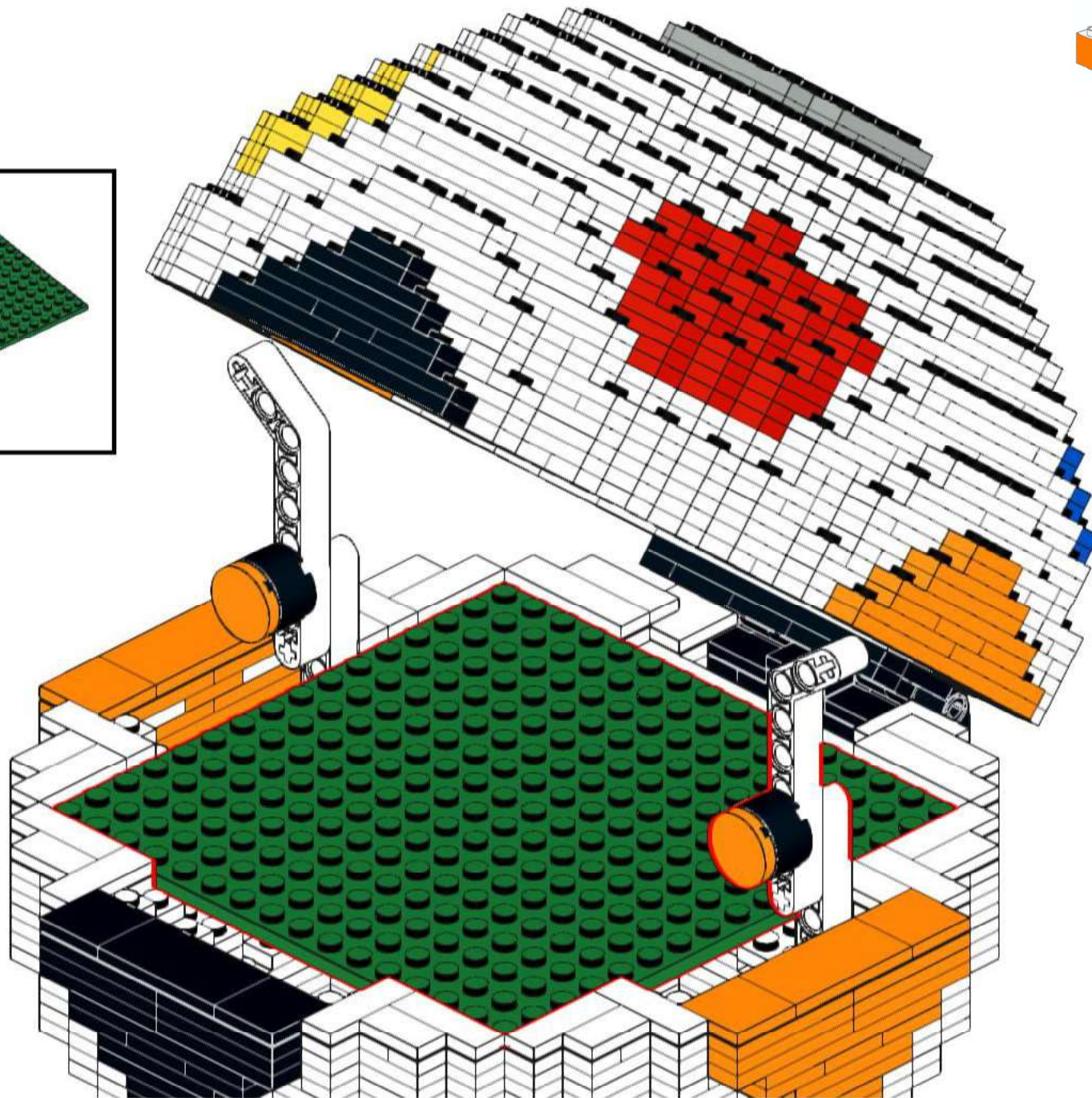
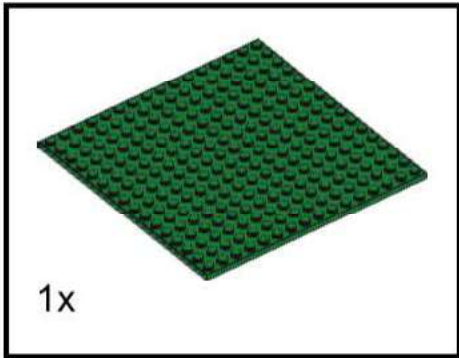

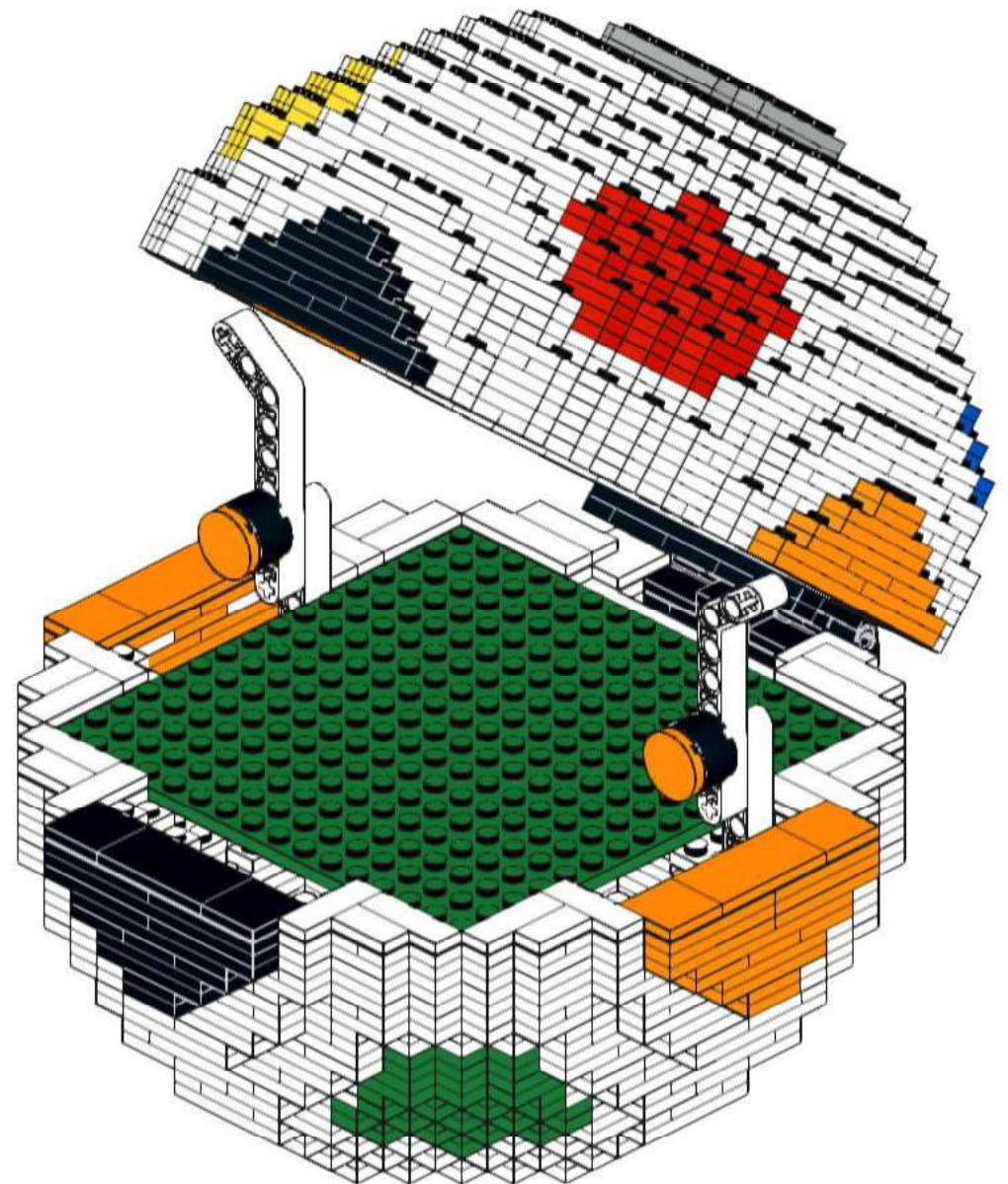
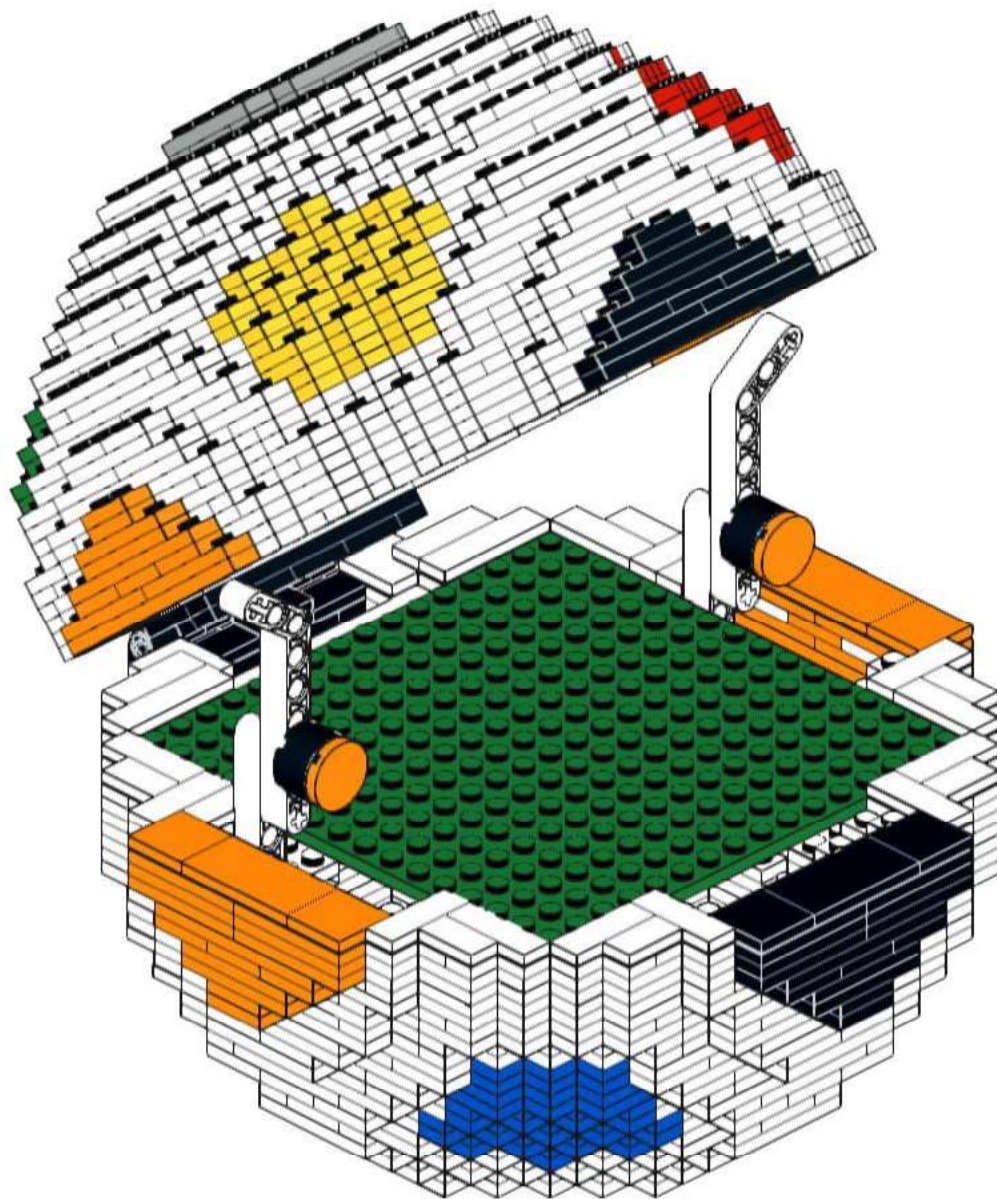

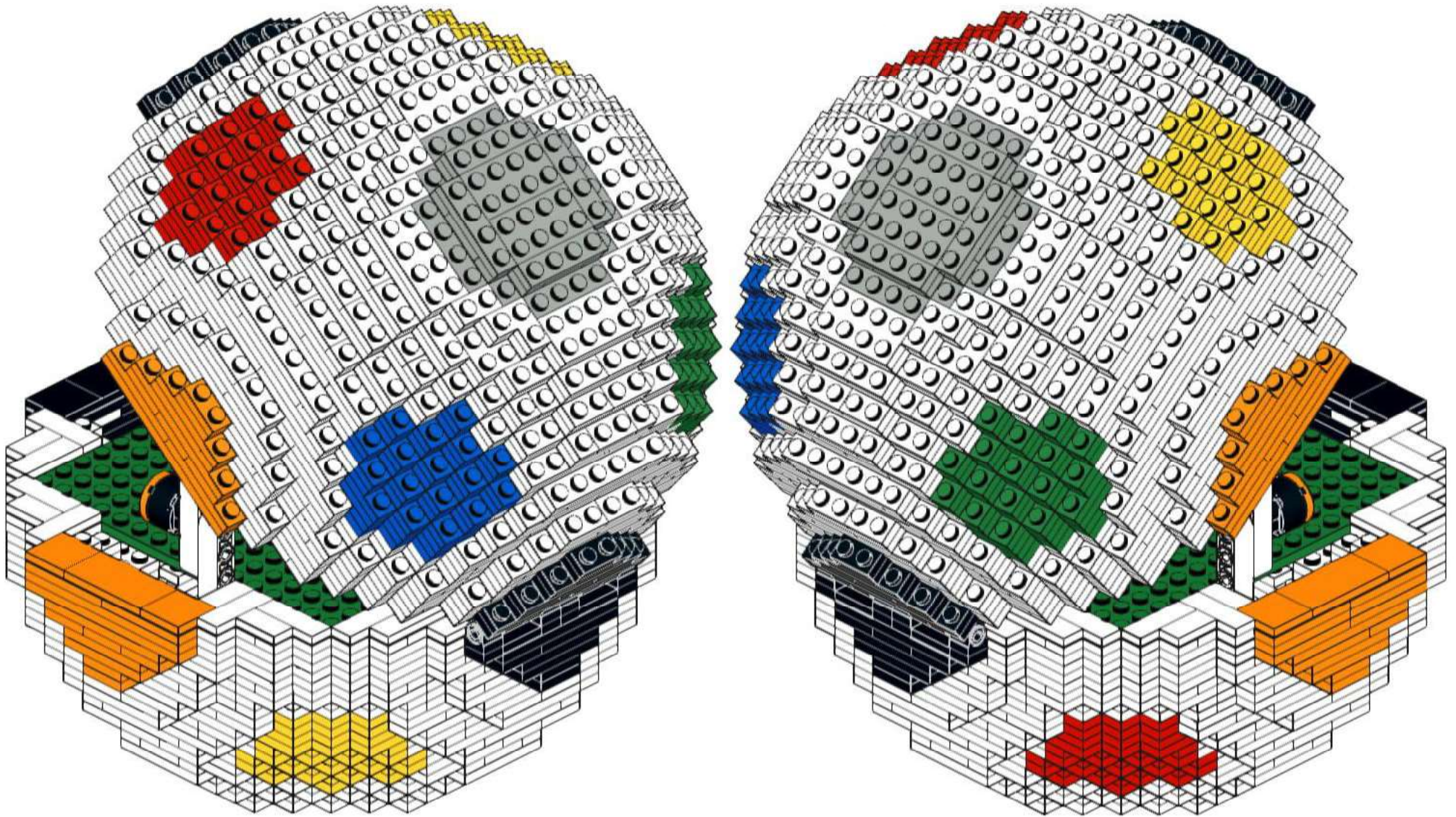

Teileliste – Flexi Ball A

(Allgemein für alle Farbkombinationen)







Design	Stein-Nr.	Anzahl	Bauteil
	3024	24	Eck- farbe
	3023	16	Eck- farbe
	3022	16	Eck- farbe
	2420	176	Eck- farbe
	3623	16	Eck- farbe

Design	Stein-Nr.	Anzahl	Bauteil
	3022	17	Neben- farbe
	3021	6	Neben- farbe
	3710	30	Neben- farbe
	87079	3	Neben- farbe
	3020	28	Neben- farbe
	3795	10	Neben- farbe
	3460	1	Neben- farbe
	3034	4	Neben- farbe

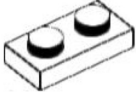
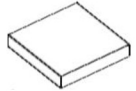
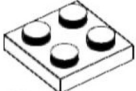
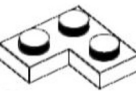
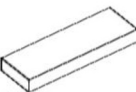
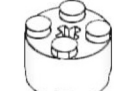
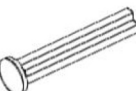
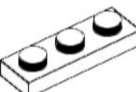
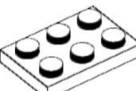
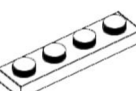
Design	Stein-Nr.	Anzahl	Bauteil
	3024	6	Neben- farbe
	3023	13	Neben- farbe
	3069	5	Neben- farbe
	3673	4	Neben- farbe
	11458	4	Neben- farbe
	28809	4	Neben- farbe
	3068	6	Neben- farbe
	2420	32	Neben- farbe
	14769	2	Neben- farbe

Design	Stein-Nr.	Anzahl	Bauteil
	3024	22	Haupt- farbe
	6541	4	Haupt- farbe
	3005	32	Haupt- farbe
	3673	6	Haupt- farbe
	43093	2	Haupt- farbe

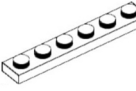
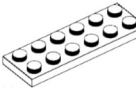
Design	Stein-Nr.	Anzahl	Bauteil
	3069	8	Hauptfarbe
	3023	114	Hauptfarbe
	3068	2	Hauptfarbe
	3022	34	Hauptfarbe
	2420	438	Hauptfarbe
	63864	14	Hauptfarbe
	6143	2	Hauptfarbe
	24316	2	Hauptfarbe
	3623	102	Hauptfarbe
	3021	172	Hauptfarbe
	3710	174	Hauptfarbe
	2431	2	Hauptfarbe
	3020	164	Hauptfarbe

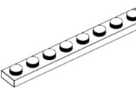
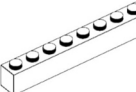
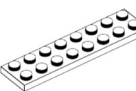
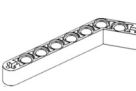
Design	Stein-Nr.	Anzahl	Bauteil
	3666	6	Hauptfarbe
	3795	39	Hauptfarbe
	32524	2	Hauptfarbe
	4162	1	Hauptfarbe
	3460	5	Hauptfarbe
	3008	1	Hauptfarbe
	3034	2	Hauptfarbe
	32271	2	Hauptfarbe

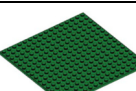
Design	Stein-Nr.	Anzahl	Bauteil
	91405	1	Platte

